

**OWNER'S HANDBOOK**

**SERVICE BOOK**

**745 i**



# OWNER'S HANDBOOK SERVICE BOOK

745i



BMW (South Africa) (Pty) Ltd.



## Standard new vehicle warranty

- The Seller hereby warrants this vehicle to be free from defects in material and workmanship in accordance with the technological standards applicable at the time of purchase.
- In the event that any defect in material or workmanship in the vehicle should manifest itself within a period of twelve months from the date upon which the Seller gives delivery of the vehicle, the Seller undertakes as follows:
  - That he will repair or replace at his own cost and without charge to the Purchaser the defective part or workmanship. The decision of the Seller as to whether the defective part should be repaired or replaced and the place where the guarantee is to be executed, shall be at the sole discretion of the Seller but shall give due consideration to the interests of the Purchaser.
  - The aforementioned undertaking is given subject to the following qualifications:
    - No claim under this Warranty will be entertained and no replacement or repair will be effected unless it is promptly reported immediately following discovery to the Seller or a BMW authorised Dealer.
    - The Purchaser shall be obliged upon discovery of the defect to bring the vehicle to the workshop of the Seller or a BMW authorised Dealer.
    - Parts for which replacements are made shall become the property of the Seller.
- This Warranty shall lapse and the Dealer shall not be obliged to give effect hereto if the Purchaser fails to have all maintenance services and oil changes performed at the specified intervals and in accordance with the instructions in the owner's handbook. Proof of such maintenance must be provided by paid invoice and the filling in of the appropriate spaces in the owner's handbook.
- This Warranty shall not apply in the following circumstances:
  - If the maintenance services and oil changes are not performed by an authorised BMW Dealer or at the specified

intervals in accordance with the instructions in the owner's handbook.

- The vehicle is used in competitive events or racing or rally events.
- The damage is due to natural wear and tear or damage attributable to negligence or improper treatment or atmospheric or environmental conditions or other damage occurring through corrosion from any cause or damage caused by accident.

5. This Warranty is given in favour of the Purchaser and all persons who may acquire the vehicle from the Purchaser within the period of 12 months aforesaid.

6. This Warranty shall not apply to the following items:

- Maintenance services, oil changes, filters.
- Incandescent bulbs and fuses.
- Wheel alignment and balancing.
- Brake linings and brake pads.
- Spark plugs, ignition points and condensers.
- Windscreen wiper blades.
- Mechanical adjustments necessitated through normal use and wear.
- Towing.
- Batteries, tyres and radios which are covered by separate limited warranties from their respective manufacturers.

7. Any items which are replaced or repaired under this Warranty shall themselves be subject to the same Warranty, namely for a period of 12 months from the date upon which the vehicle is delivered by the Seller to the Purchaser.

8. This Warranty is the only Warranty given by the Seller to the Purchaser and no liability will be accepted other than that contained in this Warranty, save, however, that nothing contained herein shall be deemed to exclude or restrict the liability of the Seller in terms of any implied guarantee or warranty. The Seller shall in particular in no way be responsible for any damage or losses sustained by the Purchaser or any other person acquiring the vehicle from the Purchaser whether direct, consequential or otherwise.

## Standaard waarborg op nuwe motor

- Hiermee waarborg die Verkoper dat hierdie voertuig vry is van defekte wat betref materiaal en vakmanskap in ooreenstemming met die tegnologiese standaard wat geld tydens aankoop.
- Ingeval die voertuig binne twaalf maande na aflewering deur die Verkoper enige defekte in materiaal of vakmanskap toon, onderneem die Verkoper:
  - Om die defektiewe onderdeel of vakmanskap op sy eie onkoste en nie op rekening van die Koper nie, te herstel of te vervang. Die besluit van die Verkoper of die defektiewe onderdeel herstel of vervang moet word en die plek waar die waarborg nagekom sal word, sal enkel en alleen na die goeddunke van die Verkoper geneem word met deeglike inagneming van die Koper se belange.
  - Bogenoemde onderneming word gegee onderworpe aan die volgende voorbehoude:
    - Geen eis kragtens dié Waarborg sal erken word nie en geen vervanging of herstel werk sal gedoen word nie tensy dit dadelik na ontdekking aangemeld word by die Verkoper of 'n gemagtigde BMW-handelaar.
    - Sodra die Koper 'n defek agterkom is hy verplig om die voertuig na die werkwinkel van die Verkoper of 'n gemagtigde BMW-handelaar te bring.
    - Onderdele wat vervang word, word die eiendom van die Verkoper.
- Hierdie Waarborg en die Handelaar se verpligting om daaraan te voldoen, verval as die Koper nalaat om al die instandhoudingsdienste en olie vervangings te laat doen op die voorskrewe tussenposes en volgens die instruksies in die eienaarshandleiding. Betaalde fakture en invulling van die betrokke ruimtes in die eienaarshandleiding sal dien as bewys van sulke instandhouding.
- Onder die volgende omstandighede sal die Waarborg nie geld nie:
  - As die instandhoudingsdienste en olie vervangings nie deur 'n gemagtigde BMW-handelaar of op die voorgeskrewe tussenposes volgens die instruksies in die eienaarshandleiding gedoen word nie.
  - As die voertuig gebruik word in mededingende geleenthede, resies of tydenne.
  - As die skade te wyte is aan normale slytasie of nalaatigheid, misbruik of atmosferiese of omgewingstoestand of korrosie weens enige oorsaak of skade veroorsaak deur 'n ongeluk.
- Hierdie Waarborg word gegee aan die Koper en alle persone wat die voertuig van die Koper mag verkry binne die genoemde 12 maande.
- Hierdie Waarborg geld nie vir die volgende items nie:
  - Instandhoudingsdienste olie vervangings, filters.
  - Gloeilampe en sekerings.
  - Wielsporing en -balansering.
  - Remvoerings en -kussings.
  - Vonkproppe, ontstekingspunte en condensators.
  - Ruitveer blaasie.
  - Meganiese verstellings genoodsaak deur normale gebruik en slytasie.
  - Insloop.
  - Batterie, buitebande en radio's wat gedek word deur afsonderlike waarborge van hul onderskeie vervaardigers.
- Alle items wat kragtens hierdie Waarborg vervang of herstel word is self ook onderworpe aan dieselfde Waarborg, naamlik vir 12 maande vanaf die datum waarop die Verkoper die voertuig aan die Koper afgelewer het.
- Hierdie Waarborg bevat die volle terme van die Waarborg wat die Verkoper aan die Koper gee en die Verkoper sal geen verdere aanspreeklikheid behalwe die soos in die Waarborg vermeld, aanvaar nie. Die Verkoper se aanspreeklikheid ten aansien van enige versweë garansie of waarborg, sal egter, niesteenstaande enige bepaling hiervan, nie beperk of uitgesluit word nie. Die Verkoper sal in die besonder geensins aanspreeklik wees vir enige skade of verlies opgedoen deur die Koper of enige ander persoon wat die voertuig van die Koper verkry het, hetsy regstreeks, gevolglik of andersins.

Dear BMW driver,

Your choice of a BMW means a vote in favour of the modern way to drive. Satisfying the driver's needs and wishes as fully as possible with an automobile that has only modest needs of its own – this ideal becomes reality in the latest BMW models.

The future has already begun for the common-sense automobile. Yet as you will soon discover, on a BMW dynamism and economy have been reconciled. You will also find that your BMW does everything it can to help you drive in a relaxed, safe manner, in perfect command of every situation. Yet one feature always associated with the name of BMW is still available in full measure: sheer driving pleasure!

Wishing you many enjoyable safe journeys.

BMW (South Africa) (Pty) Ltd.



In the interests of continuing technical development work we reserve the right to modify designs, equipment and accessories. Dimensions, weights and performance data quoted in this handbook are subject to the appropriate tolerances laid down by German Industrial Standard (DIN). Accordingly, no claims based on data, statements, descriptions or illustrations will be entertained.  
Errors and omissions excepted

**Please note that any discrepancies between your own car and the details given in this handbook may be due to the equipment specification offered on a particular model or the items ordered with the car.**

© 1984 BMW (South Africa) (Pty) Ltd.

Not to be reproduced or reprinted wholly or in part without written permission from BMW (South Africa) (Pty) Ltd.

Ons behou die reg voor om in die belang van voortgesette tegniese ontwikkeling die ontwerpe, toerusting en bykomstighede van ons motors te moderniseer. Die afmetings, gewigte en data rakende werkverrigting wat in die handleiding aangehaal word, is onderhewig aan die toepaslike veranderings wat deur die Duitse Industriële Standaard (DIN) toegelaat word. Dienooreenkomstig sal geen eise wat op sodanige data, stelling, beskrywings of illustrasies gegrond is, oorweeg word nie. Foute en weglaatings word hiervan uitgesluit.

**Let asseblief daarop dat enige verskille tussen u eie motor en die besonderhede wat in die handleiding gegee word, te wyte mag wees aan die toerustingspesifikasies van 'n besondere model of die items wat saam met 'n motor bestel word.**

© 1984 BMW (Suid-Afrika) (Edms) Bpk.

Geen gedeelte van hierdie boek mag gereproduseer of herdruk word sonder die geskrewe toestemming van BMW (Suid-Afrika) (Edms) Bpk.

**Driving your BMW: the important facts in brief 1**

---

**BMW operating instructions in full detail 2**

---

**BMW safety: the contribution you can make 3**

---

**BMW driving methods and  
how to keep running costs low 4**

---

**Care of your BMW –  
minor defects and repair hints 5**

---

**BMW specifications –  
data and technical descriptions 6**

---

**BMW service –  
maintenance related to use of the car 7**

# Driving your BMW: the important facts in brief

1



Driver's seat

Controls

Instrument cluster

Heating and ventilation

Before you start

Filling the fuel tank

At a glance:

filling capacities, V-belts,  
spark plugs, tyre pressures

ZA 23 82 01 1000 00



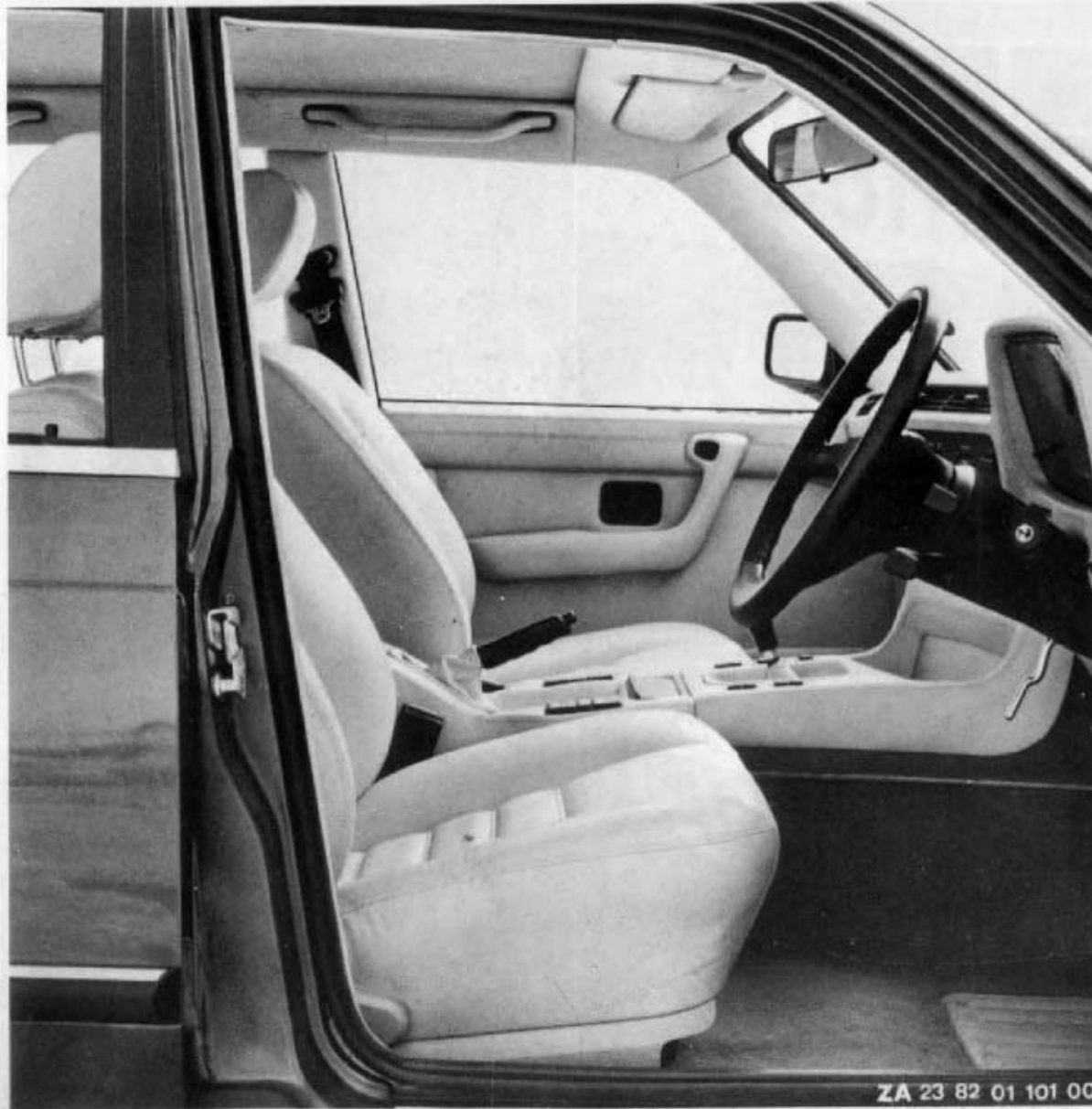

### Driver's seat

The electrically operated front seat adjustment is activated by a push-button combination.

- 1 = Backrest inclination
- 2 = Horizontal seat adjustment
- 3 = Head-rest height adjustment
- 4 = Seat height adjustment rear
- 5 = Seat height adjustment front

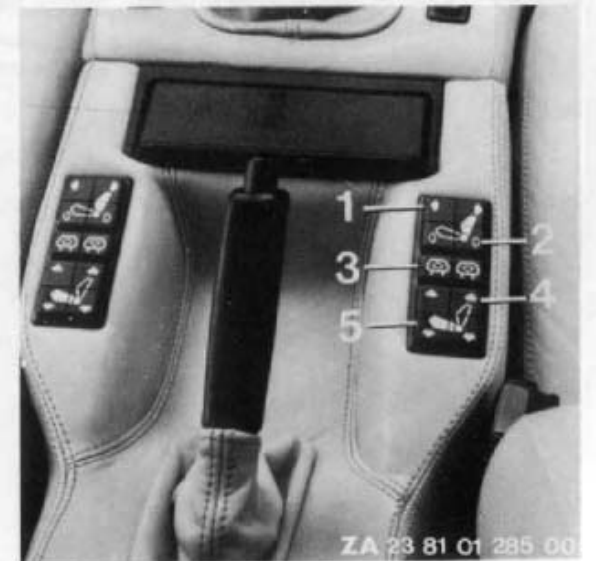

## Controls and instruments

- 1 – Speedometer with cumulative and trip distance recorders
- 2 – Coolant thermometer
- 3 – Revolution counter
- 4 – Lever for turn indicators, parking lights, low/high headlight beams and headlight flashing
- 5 – Main light switch
- 6 – Fuel gauge with low fuel level warning light (orange)
- 7 – Ignition/starter switch
- 8 – Fog light switch
- 9 – Windshield wiper/washer lever
- 10 – Active Check-Control
- 11 – Lever for cruise control.

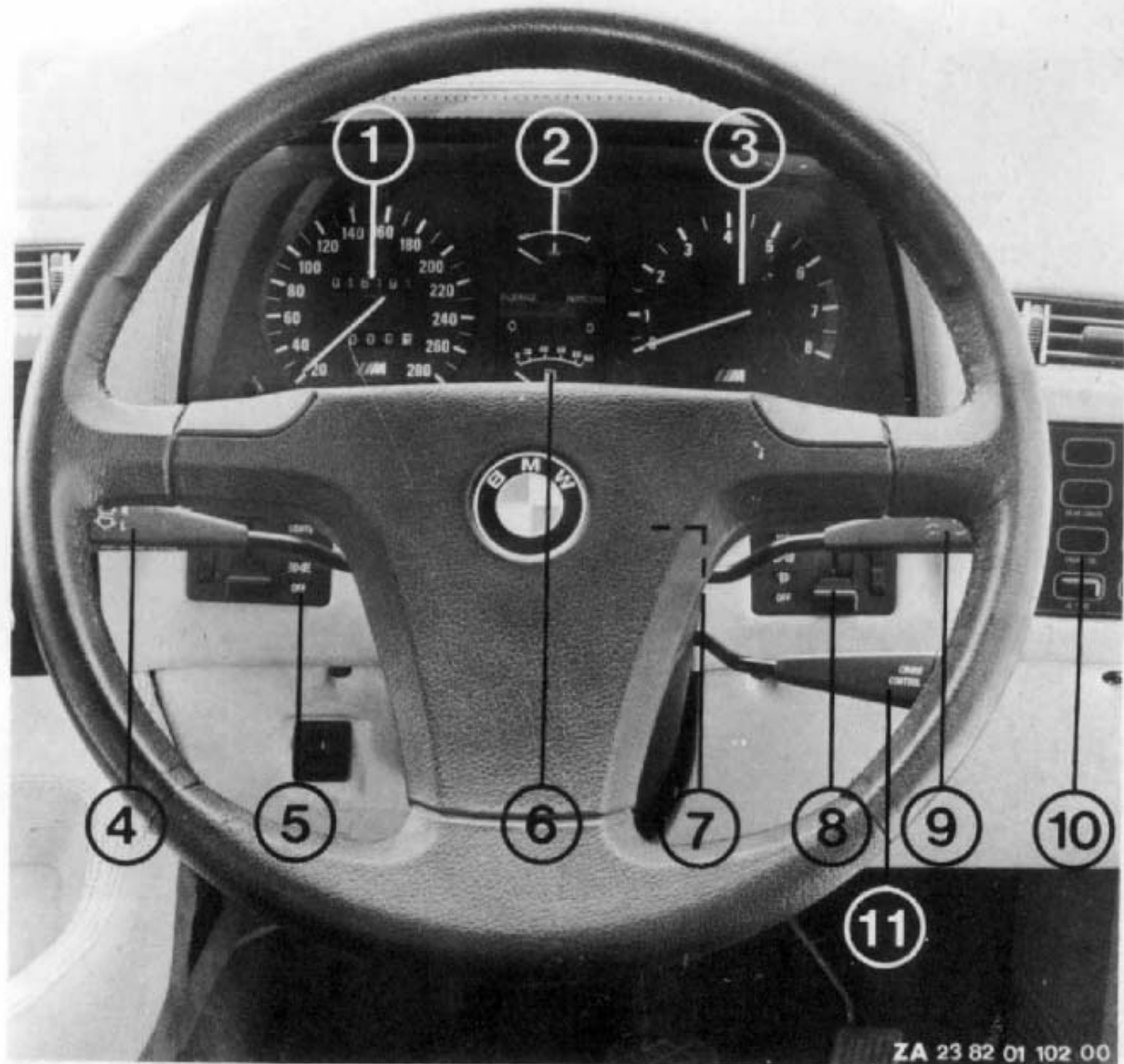

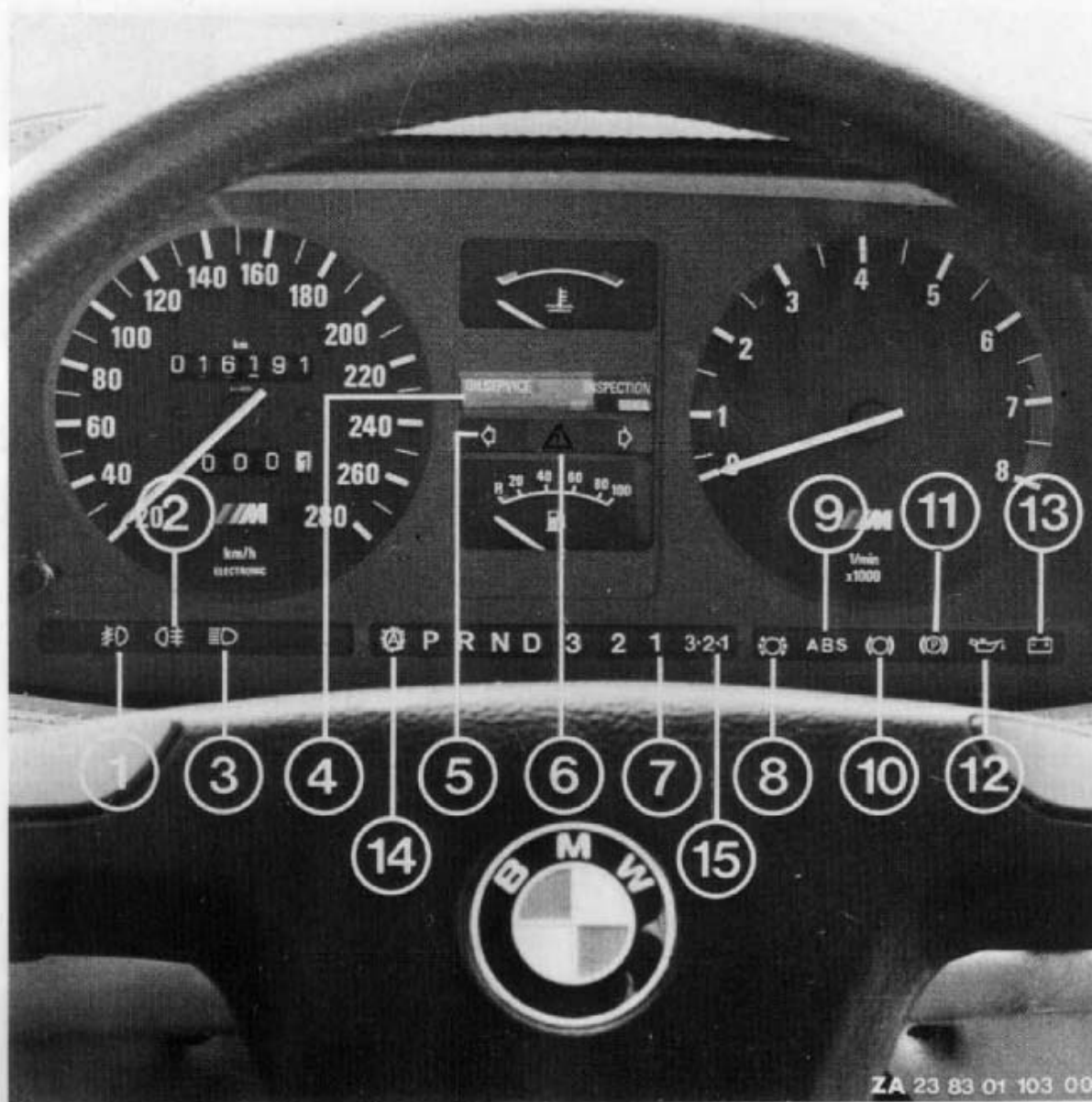

### Instrument cluster

Apart from the main dials, this includes warning and telltale lights for:

- 1 – Front fog lights (green)
- 2 – Rear fog lights (yellow)
- 3 – High beam headlights (blue)
- 4 – Service interval indicator (green-yellow-red)
- 5 – Flashing turn indicators (left and right) (green)
- 6 – Central warning light for Active Check-Control (yellow)
- 7 – Selector lever position indicating lights (on cars with automatic transmission)
- 8 – Brake pad wear indicator (red)
- 9 – Antilock braking system (ABS) (yellow)
- 10 – Brake fluid level and, if necessary, system and reservoir pressure (red)
- 11 – Handbrake (red)
- 12 – Engine oil pressure (red)
- 13 – Battery charge (red)
- 14 – Electronic shift indicator
- 15 – Direct shift programme (on cars with automatic transmission)



## Heating and ventilation

- 1 – Airflow volume (knurled wheel)
- 2 – Temperature (knurled wheel)
- 3 – Temperature sensor
- 4 – Push button – rear-seat air distribution
- 5 – Push button – recirculating air
- 6 – Push button – upper and lower air distribution without air-conditioning
- 7 – Push button – automatic air distribution without air-conditioning
- 8 – Push button – upper, centre and lower air distribution with air-conditioning
- 9 – Push button – automatic air distribution with air-conditioning.
- 10 – Push button for de-icing windows.

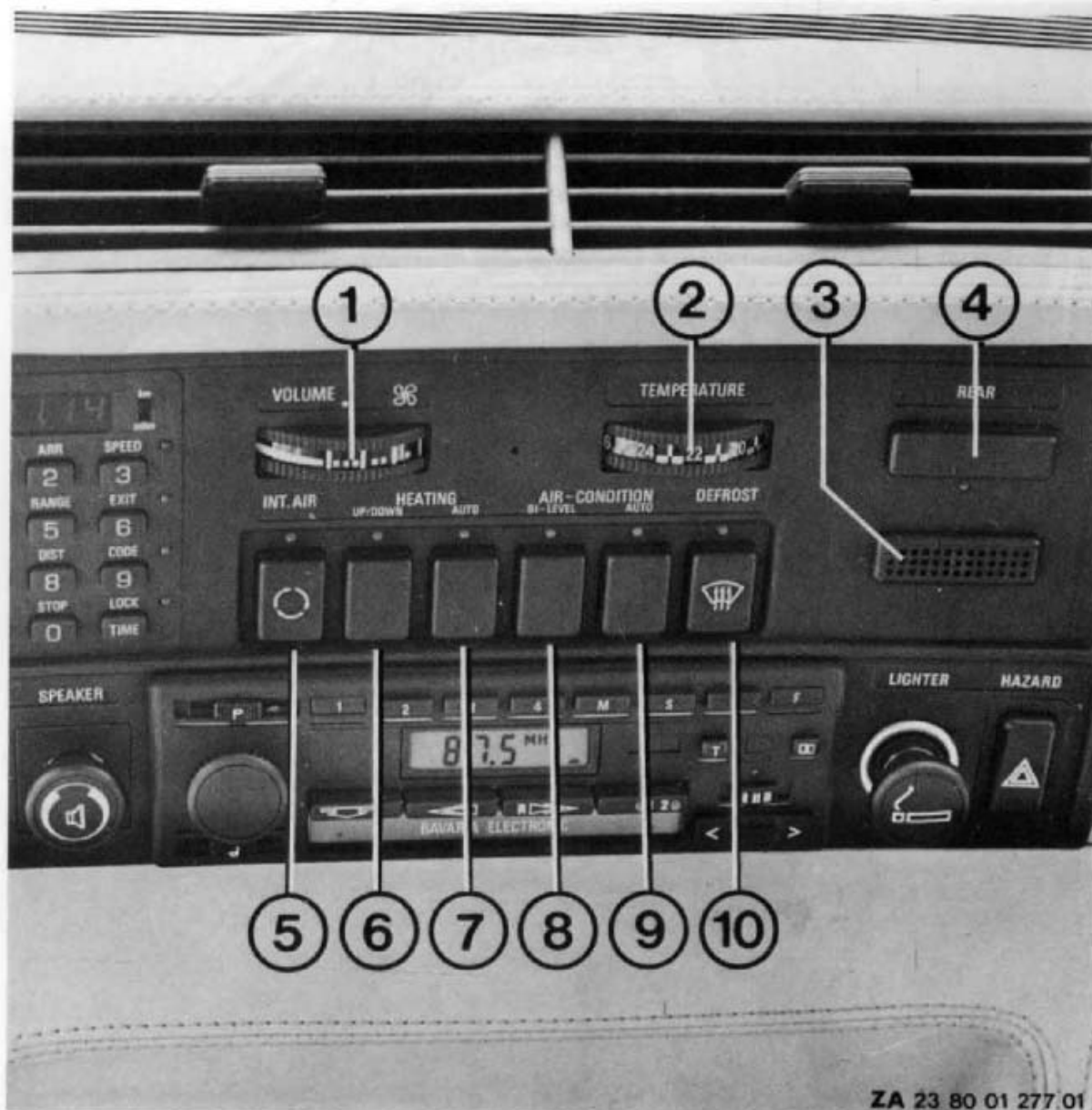

ZA 23 80 01 277.01

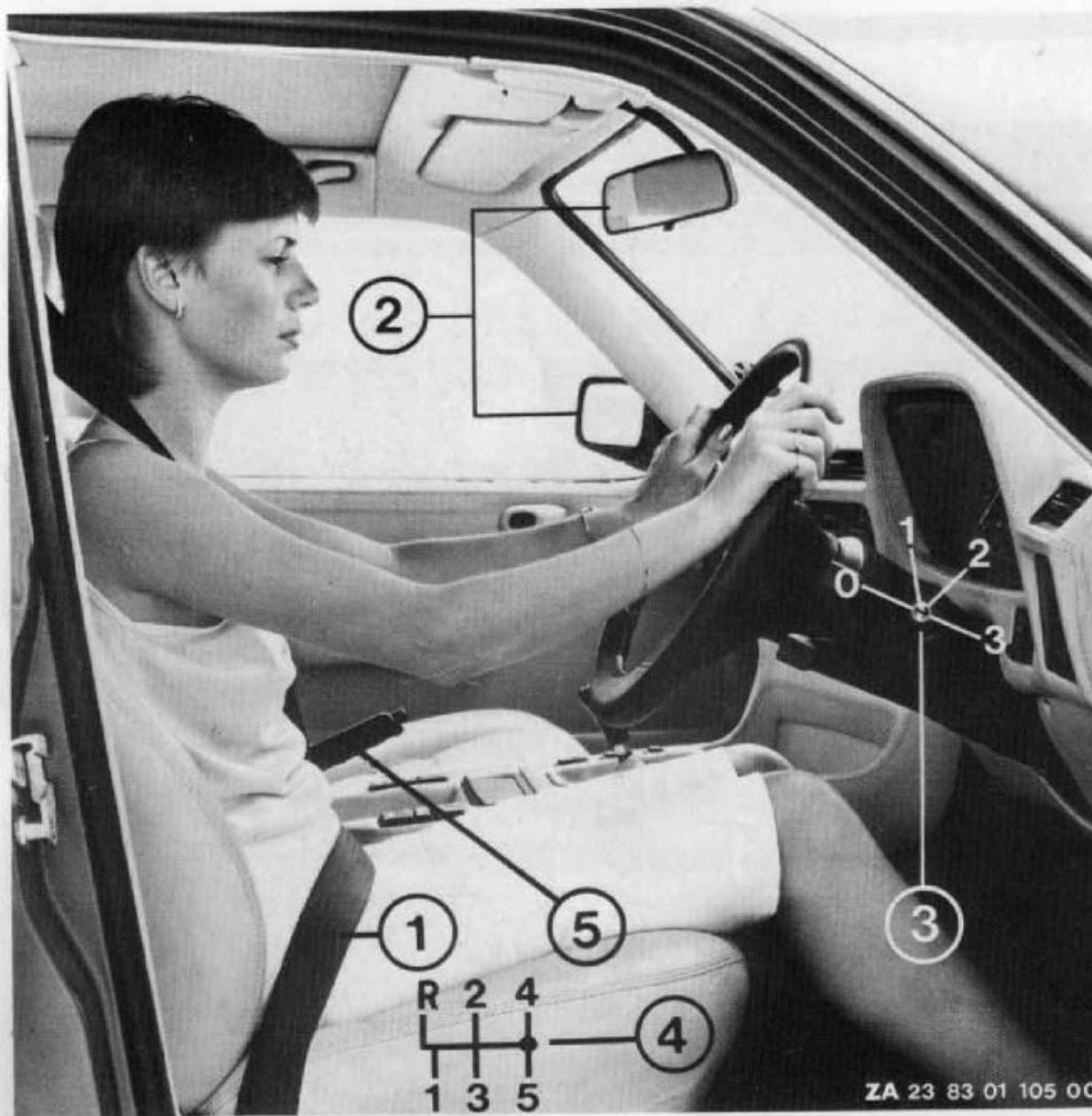

### Before you start

- 1 – Attach your seat belt properly first.
- 2 – Check inside and door mirror settings and adjust if necessary.
- 3 – Ignition/starter switch positions:
  - 0 = Park (steering locked with key removed)
  - 1 = Radio (to listen to radio in parked car)
  - 2 = Drive
  - 3 = Start

### 4 – Gate pattern for 5-speed gearbox

Automatic transmission selector lever positions:

- P = Park
- R = Reverse
- N = Neutral
- D = Drive (automatic gear selection)
- 3 = Direct drive

- 2 = Hill climbing and engine braking
- 1 = Hill climbing and engine braking

Switch positions for electronic – hydraulic control.

- E = Economy programme.
- S = Sports programme.
- 3.2.1. = Direct shift programme.

- 5 – Release the handbrake before driving away.

ZA 23 83 01 105 00

### Filling the fuel tank

If the fuel gauge needle has dropped to the red warning zone, and the orange "Tank" warning light (low fuel level) has come on, you should fill the tank without delay, although enough fuel remains for a distance of about 50 km, depending on driving style and speed.

1 – Fuel filler cap

Check regularly:

2 – Tyre pressures, front and rear (including the spare wheel). For correct tyre pressures, see page 1-9.

3 – Engine oil level, coolant level, windshield washer fluid level, automatic transmission fluid level, power steering circuit oil level, brake fluid level (see **Section 4** of this handbook).

Before continuing your journey, clean:

4 – Windshield, and if necessary the side and back windows, door mirrors, headlights, rear lights and licence plates.

Overflowing fuel in the area of the fuel filler should be wiped off immediately.

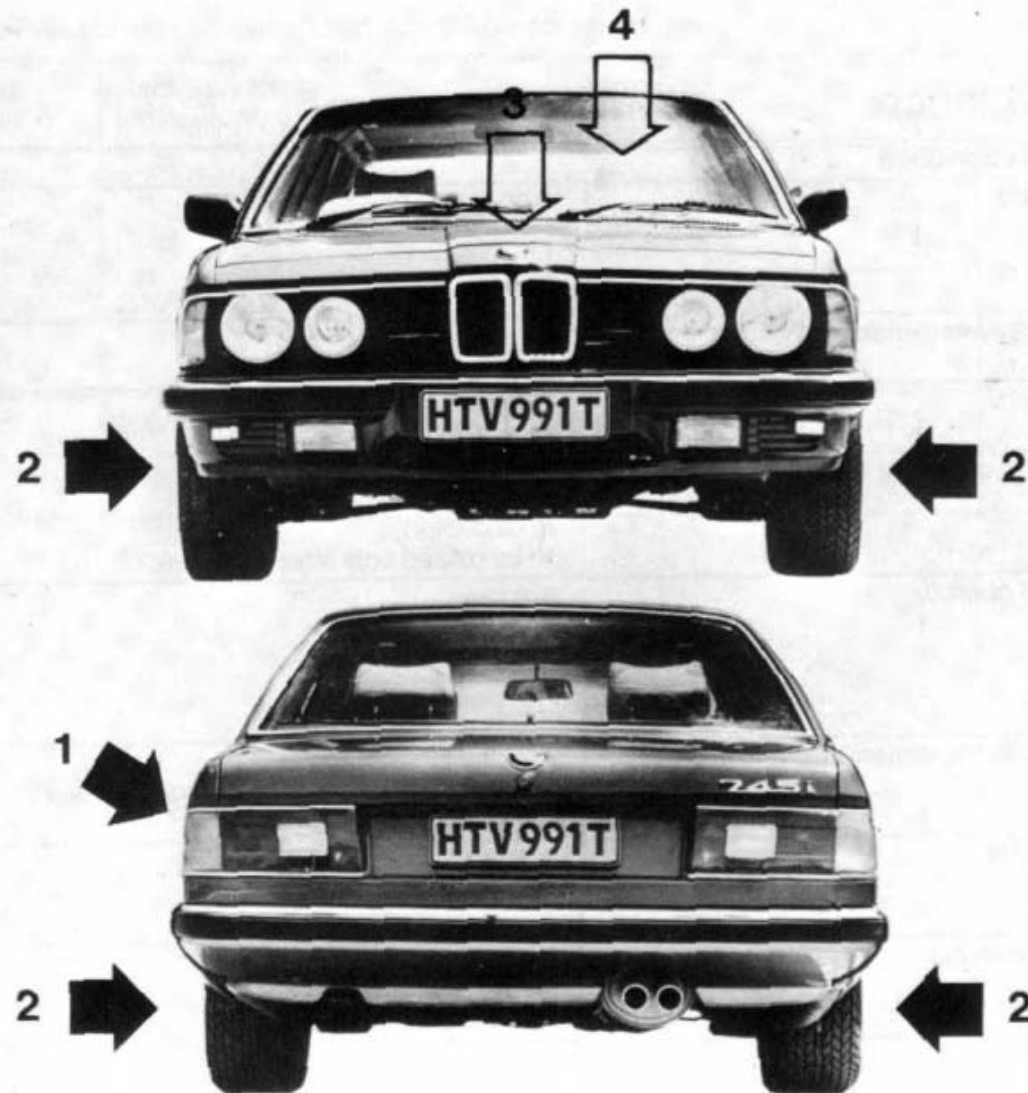

ZA23 83 01 106 00



## At a glance

Filling capacities		Notes
Fuel tank	100 litres	<b>Super (premium) fuel</b> to DIN 51 600 standard, min. octane number 98 (Research Test Method), 88 (Motor Test Method) at sea level.
Cooling system including heater circuit	12 litres	For details, see page 4-13
Engine oil	5 litres plus 0,75 litre if oil filter is changed; + 0,75 litre in oil cooler; to be refilled only after repair work	Brand-name HD oil for spark ignition engines; for grades, see page 4-11
Manual gearbox	1,6 litres	Brand-name gearbox oil, SAE 80, specification MIL-L-2105 A or API-GL 4 (use HD engine oil as a substitute only: single grade mineral-oil base, Specification API-SE or SF, SAE 20/30/40
Automatic transmission	App.3,0 litres total content of new or exchange gearbox 3,0 litres	For oil grades, see page 6-28
Final drive	1,9 litres	Brand-name running-in grade hypoid gear oil, SAE 90; your BMW service station knows the factory-approved grades
Power steering	2,0 litres permanently filled, no drain plug	For oil grades, see page 6-20

**Spark plugs**

Champion A-6G

Electrode gap

0,5 + 0,1 mm

**Warning: transistorized coil ignition and digital motor electronics**

This is a high-output ignition system, and any contact with "live" components when the engine is running could cause a severe or even fatal electric shock.

**V-belts****Alternator and coolant pump**

12,5 x 1060 LA

**Power steering pump**

9,5 x 900 LA

**Air-conditioning compressor**

12,5 x 800 LA

**For your own safety – check tyre pressures regularly**

**Tyre Pressures** in bars when cold; add 0,3 bar for warm tyres.

BMW model	Radial-ply tyres, tubeless	Load on car	Tyre pressures	
			Front	Rear
745i	205/55 VR 16 (front)	max. 4 persons	2,5	
		heavier loads	2,8	
	225/50 VR 16 (rear)	max. 4 persons		2,5
		heavier loads		2,9
745i	220/55 VR 390	max. 4 persons	2,2	2,2
		heavier loads	2,5	2,5

In this section of the handbook, we described in brief the main items you need to know when driving your BMW.

More detailed information of interest to you is given in the section "OPERATING INSTRUCTIONS" (**Section 2**).

The "SAFETY" section (**Section 3**) deals with the vital topic of using the seat belts and with the other steps you can take to enhance your safety and that of your passengers.

After this, we provide "DRIVING HINTS" in **Section 4**, including interesting facts concerning economical driving, the disc brakes, the tyres, driving in cold weather and towing a trailer. This section also includes instructions for checking the various fluid levels on the vehicle regularly.

"CARE OF THE CAR" (**Section 5**) not only deals with the best methods of looking after your BMW, but also gives details of some of the minor repairs and adjustments you may prefer to carry out yourself.

The "TECHNICAL FEATURES" in **Section 6** will be of interest to the owner or driver wishing to study the performance and equipment specification of his or her BMW in full detail.

For these technical features to function reliably over a lengthy period, correct maintenance is essential. The section headed "SERVICE" (**Section 7**) describes the work to be carried out on your BMW as part of the BMW Maintenance System.

We are sure that all this information will prove to be of interest to you, and repay careful study.

# BMW operating instructions in full detail

2



Keys, locks, maker's plate

Seats

Switches, instruments and controls

Service Indicator

Active Check-Control

Check-Control

Manual gearbox

Automatic transmission

Automatic Cruise Control

Car radio

Sliding/vent roof

Heating and ventilation

On-board computer

Special equipment options

Starting instructions

Running-in rules

Fuel



## Before you start – all you need to know

Four keys are supplied with your new BMW:

- 1 – Master key as in illustration 2, with battery and light in head of key,

To switch on the light, press the button. Renew the battery when the light glows less bright, or else acid may leak out of the run-down battery.

- 2 – Duplicate master key.

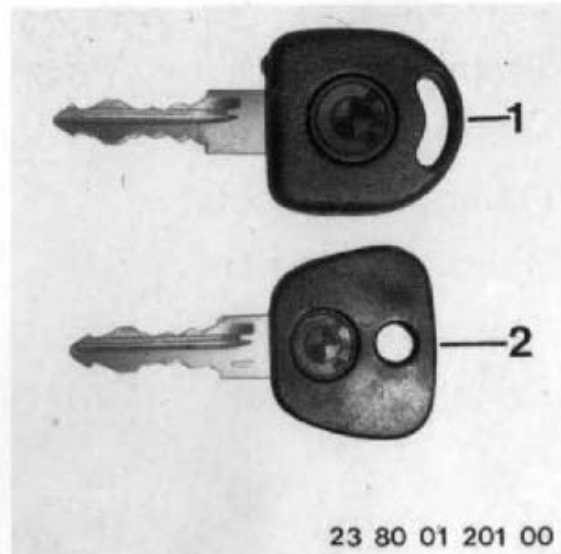

- 3 – Key for doors and ignition; does not fit luggage compartment or glove box. (Service key)

- 4 – Spare master key with extra-small head, to be kept in a billfold or purse.

In case you are obliged to have new keys cut, you will also receive:

- 5 – Key number on self-adhesive label.

The master keys fit all the locks on your BMW, but the other keys only fit the two front doors and the ignition/starter switch.

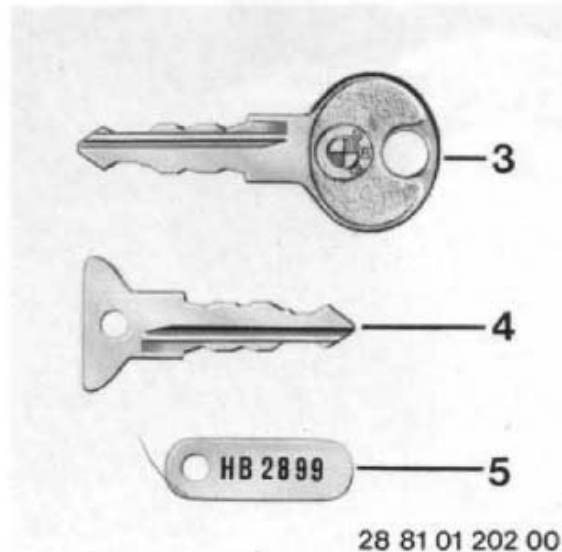

You can therefore lock valuables or luggage in the luggage compartment or glove box out of sight but still hand a key to a workshop or hotel porter so that the car can be driven.

Keep the small-headed master key where it is easily accessible if the other two master keys are lost or unobtainable.

To open a door from the outside, lift up the handle plate.

The heated driver's door lock is switched on when the driver's door handle is raised.



To lock the doors from the inside, push down the safety catch buttons. To open from the inside, first lift up the safety catch button then raise the handle above the armrest.

When the driver's door is open its lock button cannot be pressed down, to prevent locking yourself out of the car accidentally.

The **front passenger's door** and the two **rear doors** are locked by pressing down the safety catch buttons, even if the doors are open. The buttons remain down when the doors are closed.

Each of the rear doors has a **childproof safety catch**, accessible only when the door is open.

Catch lever up = door can be opened from outside or inside.

Catch lever down = door can be opened from outside **but not from inside**.

The **luggage compartment lid** is locked and unlocked with the master key.

Remember to lock the luggage compartment after closing it. If the car has the central locking system, this will not be necessary unless the luggage compartment is to be secured against unauthorized opening with the car itself remaining unlocked.

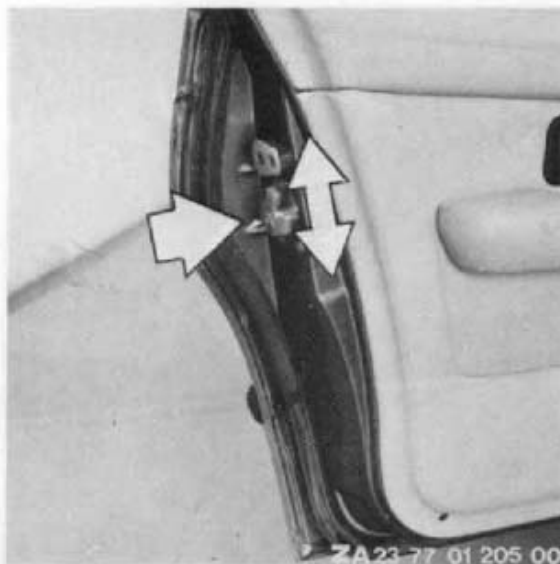
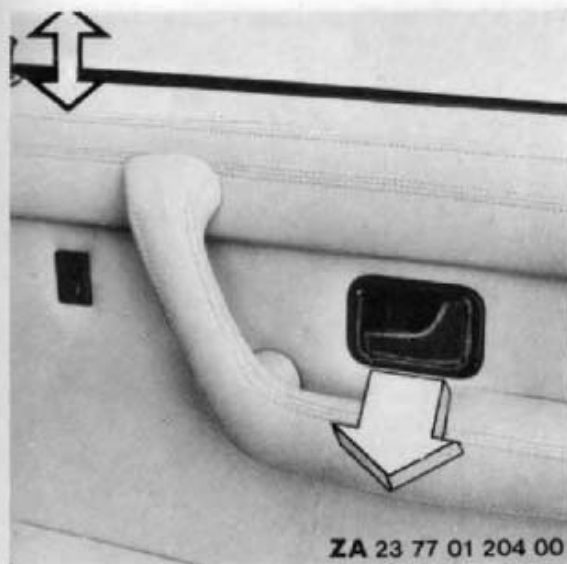

### Central locking system

Whenever a door lock or the luggage compartment lock is operated or the safety catch button on the driver's door pressed down, the doors, the luggage compartment lid and the fuel filler flap lock at the same time. However, the door lock buttons can also be operated separately.

By turning the **driver's door key** further to the right (clockwise), the central locking system for the doors is put out of action (in preparation)

The luggage compartment can be locked separately via the central locking system by turning the key to the right and pulling it out from the end position. It can then only be opened with the master key. This is a useful device for keeping the luggage specially secure.

### Important note:

Children left in the car could lock the doors from the inside. To avoid this, make a point of removing the ignition key and taking it with you, so that the doors can always be opened from the outside.

The **engine compartment lid** is opened from inside the car by pulling the lever on the left side panel of the footwell.

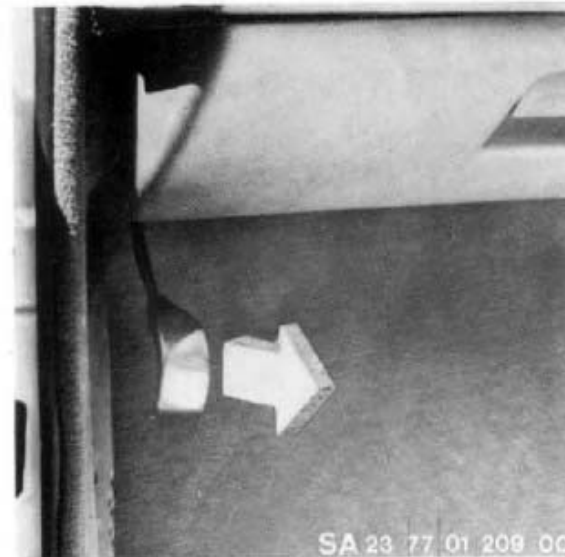

A built-in mechanism makes it easy to open and raise the lid from the outside after release

**Warning:** make sure that the release lever is still pulled back before closing the lid. After closing the lid, lock it by pushing the lever forwards.



The **maker's plate** and **chassis number** can be used to check the identity of your car against the registration and licensing papers.

The type reference, chassis number and other data are entered in the car's logbook or registration document, and on the licensing or ownership certificate. Compare these entries with the references stamped on the vehicle in case a mistake has been

made. The car's data are used as a basis for all queries, examination of records or warranty or other claims. You should therefore be familiar with the locations of the items concerned.

**Maker's plate:** in the engine compartment, on the right wheel arch (looking forwards).

**Chassis number:** in the engine compartment, on the right side on the damper housing (looking forwards).

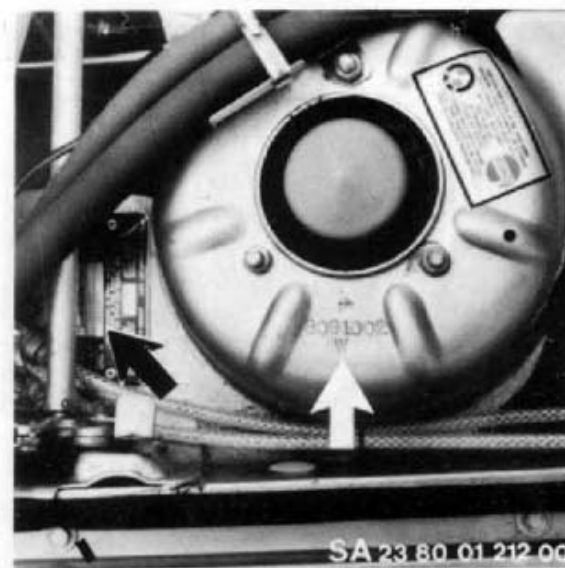



To **reposition the front seats** in relation to the steering wheel. Press button 1 or 2.

The **front seat backs** can be altered in angle by pressing button 3 or 4. With the seats slid fully forward and the headrests pulled out, the seats can be fully reclined.

To alter the **height and angle** of the front seats, press button 5-6 or 7 and 8. It may then be necessary to reposition the seat (backwards/forwards) or alter the seat back angle. See **Section 3**.

After a desirable sitting position is attained manually (switches 1-8) it can then be programmed into the memory which can hold up to three alternative sitting positions.

Programming is carried out by turning the ignition/starter switch on and depressing one of the recessed push-button switches 9 for the position to be memorised.

To recall a stored seat position, press one of the switches 11 and the seat will automatically adjust to the position that has been programmed to its memory. (Green LED 10 will go out once stored seat position is reached.) If the seat position is to be altered while engine is running, the call button 11 has to be held until seat reaches memorised position. (This is for safety reasons.) In this case the green LED 10 will flash once the position is reached.

The red LED 12 will come on to indicate malfunction in the system. The stop button is used to switch off the entire electrical operating program.

**Note:** Operating any of the manual controls or call push-buttons will the automatic mode is in operation will disturb seat adjustment.

After pulling out the clamp lever, the **steering wheel can be extended or retracted** to any desired position in relation to the seat. Secure the steering column in its new position by tightening the clamp lever again. See **Section 3**.

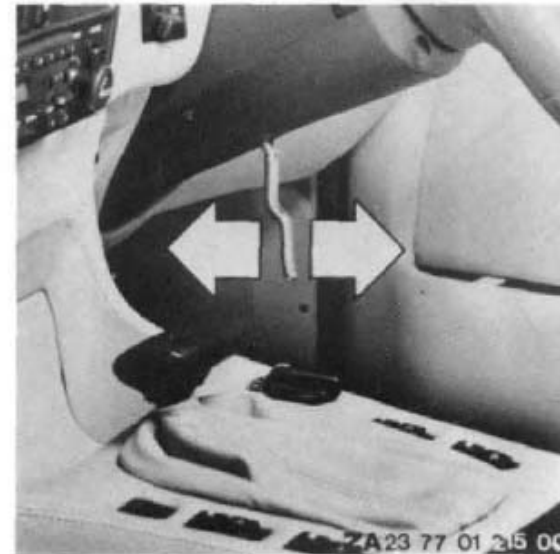
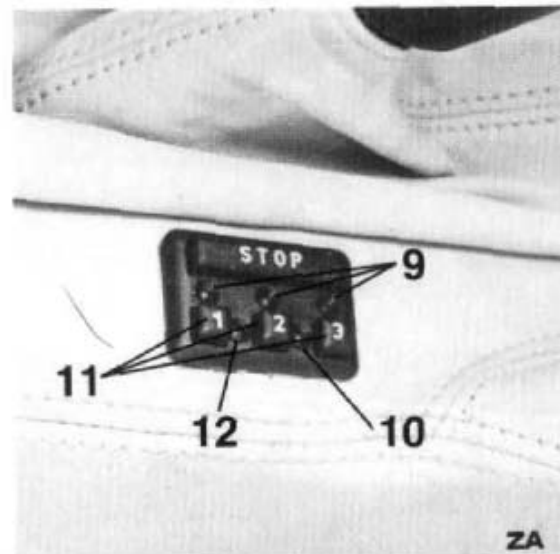
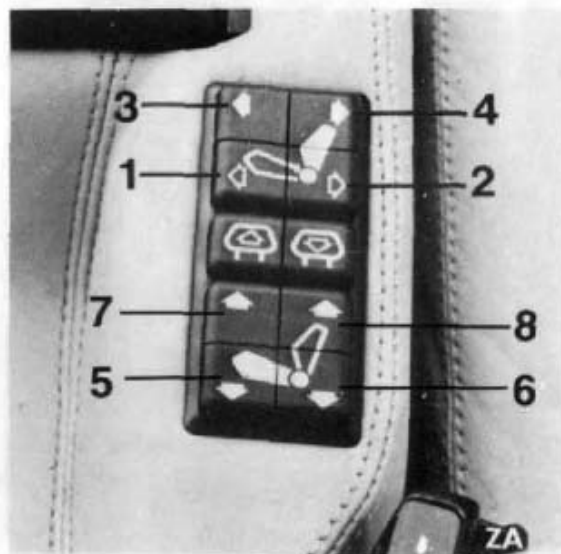

Your BMW is equipped with automatic (inertia-reel) lap and diagonal **seat belts** for the front and outer rear seats.

Full details of how to use the seat belts, BMW child's seat and restraint systems are given in **Section 3**.

The front **head restraints** can be varied in height by pressing button 1 or 2. The angle of the headrests can also be altered by moving them forwards or backwards. See **Section 3**.

The **rear-seat head restraints** can also be varied in height and angle.

The **electrically adjustable individual rear seats** can be moved forward by approximately 70 mm by operating rocker switches conveniently located on the front of the fixed seat centre section. Both the seat backs and the automatic-reel seat belts, if worn, adjust to the new position when the seat is moved.

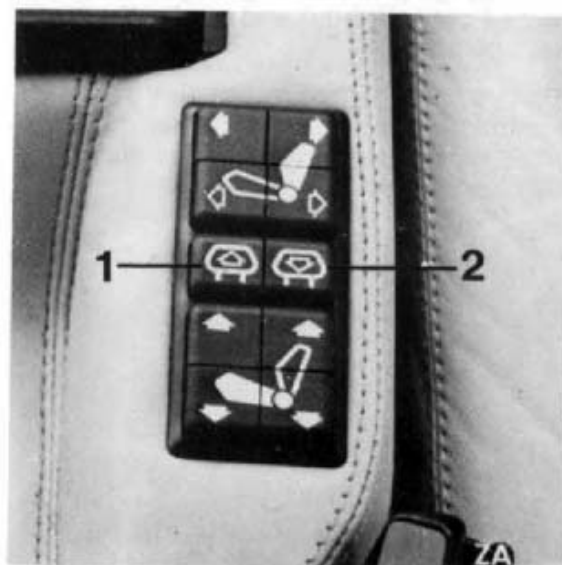

The **ignition/starter switch**, in the right steering column surround, is combined with the steering lock.

0 – Steering locked. The key can **only** be inserted and removed in this position.

All items of electrical equipment are switched off, except for the following, which remain operational: hazard warning flashers, lighter, interior light, side/parking lights, etc.

To release the steering lock it may be necessary to turn the steering wheel slightly.

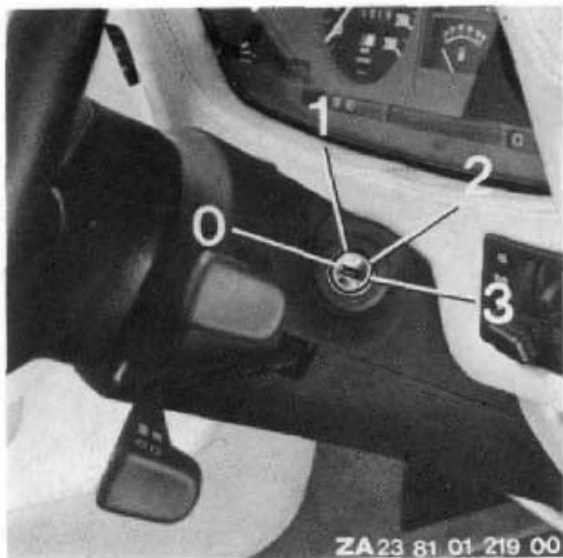

To lock the steering, pull out the key and turn the steering wheel to left or right until the lock is heard to engage.

- 1 – Steering unlocked. Radio, on-board computer, front and rear fog lights, flashing turn indicators, horn and windshield wipers can be operated.
- 2 – Ignition switched on. All other items of electrical equipment can be operated.
- 3 – Starter motor operated. As soon as the engine starts, release the ignition key. It will spring back to position 2.

#### Important notes:

**Never run the engine in an enclosed space. The exhaust gas contains carbon monoxide, which although colourless and odourless is extremely toxic.**

**Never pull out the ignition key when the car is moving, or else the steering lock will engage (the steering may need to be turned only slightly) and render the car uncontrollable.**

**Always remove the ignition key and take it with you when leaving the car unattended. Make sure that the steering lock has engaged.**

The **main light switch** has two positions;  
Position 1: Sidelights  
Position 2: Low headlight beams

If the ignition key is turned to position 1 or 0 with the headlights on, they will go out, but the sidelights will remain alight.

The intensity of the **instrument, ashtray and control inscription lighting** can be continuously varied by turning the knurled wheel.

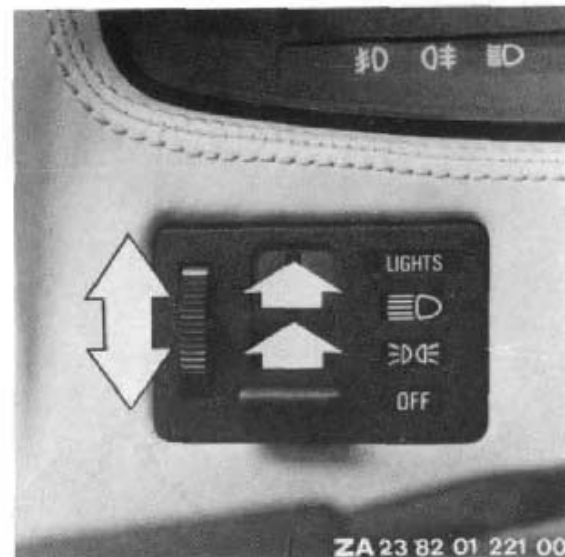

The lever at the left of the steering column controls the **headlights (high or low (dipped) beam)**, after the main light switch has been turned on) and the **flashing turn indicators**. It can be operated with the fingers of the left hand, without having to remove the hand from the steering wheel rim. The **high headlight beam setting** (lever pushed forward) is indicated by a blue tell-tale light on the instrument panel. To **flash the headlights**, pull the lever back toward the steering wheel rim.

Move the lever up to operate the right **flashing turn indicators**, or down to signal a left turn.

A green tell-tale or repeater light on the instrument panel will flash and a ticking sound will be heard in the same rhythm as the turn indicators light up, to confirm that the turn signal is being displayed.

When you return the steering wheel to the

straight-ahead position, the turn indicator level will be automatically cancelled. However, if the turn was only slight, you may have to cancel the lever by hand. To display a flashing turn signal for a short period only – when changing lanes, pulling out to overtake or starting away from the roadside, etc. – you need only press the turn indicator lever slightly away from its rest position, without allowing it to engage. When released, the lever will immediately switch off even if the steering wheel is not turned.

**Parking lights** at front and rear on either side of the car can be turned by moving the flashing turn indicator lever as far as the detent after the steering lock has been engaged by turning off the ignition key.

Lever positions:

- Up – right front and rear parking lights
- Down – left front and rear parking lights

The **wipe-wash lever** is on the right of the steering column, and has the following switch positions:

- 0 – Wipers off
- 1 – Intermittent wipe
- 2 – Normal wiper speed
- 3 – Fast wiper speed
- 4 – Single wipe

Pulling the lever up toward the steering wheel rim operates the automatic wash-wipe system.

In the intermittent-wipe position, the wipers perform a single movement at brief intervals. This means that the driver need not turn the wipers on and off repeatedly in light rain, snow, etc. Select wiper position 3 only in heavy rain or snow.

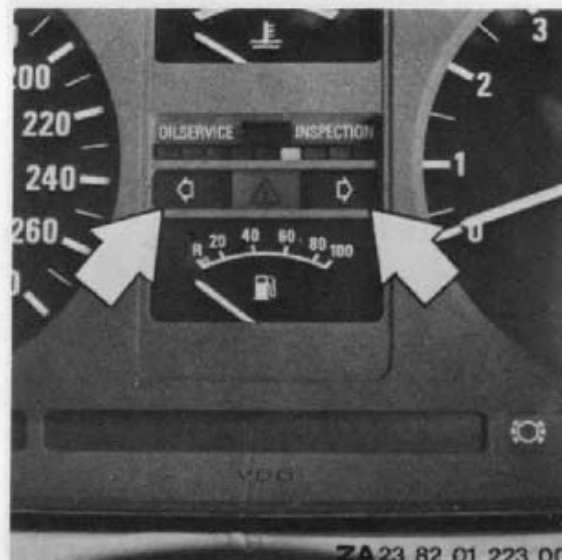



The silicone remover can be sprayed on to the windshield before actual washing takes place, by pressing the end of the lever. The remainder of the windshield cleaning process takes place automatically.

The **fluid reservoir**, which holds approximately three litres, is at the front right of the engine compartment.

The intensive-cleanser reservoir (this product is available from your BMW dealer) is next to the windshield washer fluid tank.

**Warning:** do not run the windshield washer if the fluid tank is empty.

The correct directions for the **windshield washer jets** are illustrated below. If the jets fail to strike the glass in the centre of the area cleaned by the wiper, they can be repositioned with a fine needle.

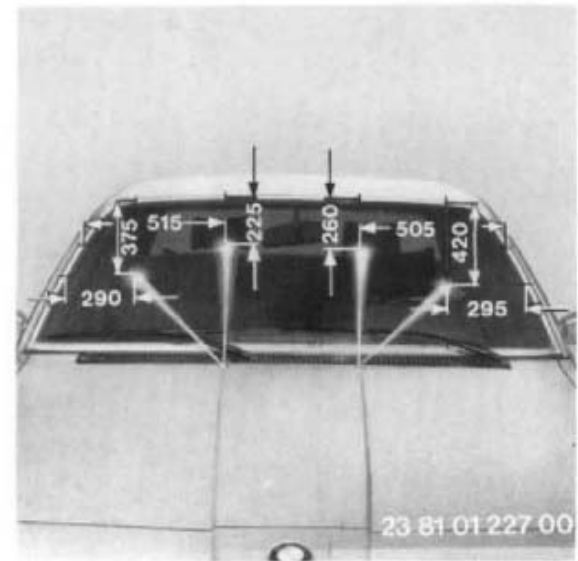
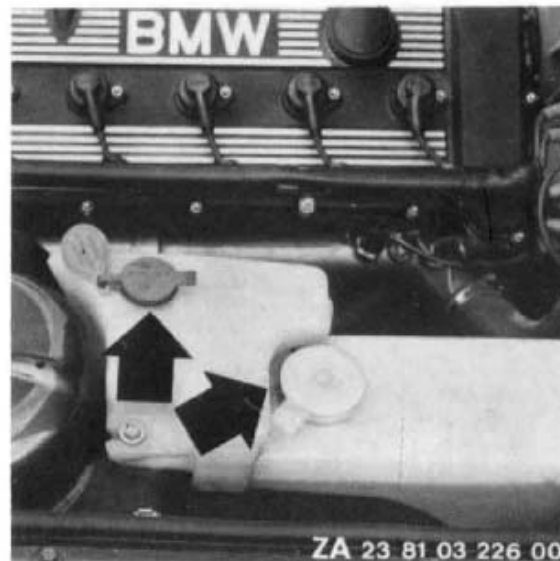

If the **rear fog lights** are switched on, the yellow tell-tale light on the instrument panel will also come on. (See **Section 3.**)

The **fog light switch** has two positions:

Position 1 – front fog lights

Position 2 – front and rear fog lights

Whenever the front fog lights are in use, a green tell-tale light on the instrument panel comes on.

The **interior light** switch has three positions:

Position 1: light is only when a door is open (courtesy switches on doors)

Position 2: light permanently on

Position 3: light permanently off.

The **automatic interior light** is switched on by lifting up the driver's door handle plate.

The interior light remains on for 6-8 seconds after all the doors have been closed, but goes out when the driver turns the ignition key.

The **reading lamps** at the right and left of the rear passenger compartment can be operated separately.

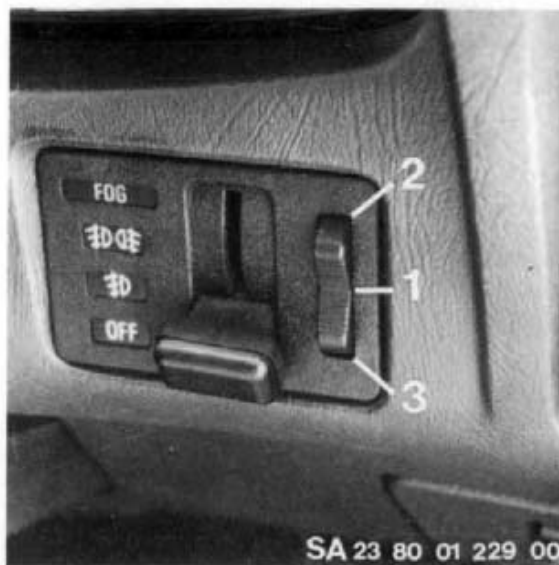

The **instrument panel** contains two main dials, the speedometer and a revolution counter; in addition, a fuel gauge, a coolant thermometer and the following warning, repeater and tell-tale lights are provided:

- 1 – Front fog lights (green)
- 2 – Rear fog light(s) (yellow)
- 3 – High beam headlights (blue)
- 4 – Service Interval Indicator (green-yellow-red)
- 5 – Left and right flashing turn indicators (green)
- 6 – Central warning light for Active Check-Control (yellow)
- 7 – Selector lever position indicating lights (on cars with automatic transmission)

- 8 – Brake pad wear indicator (red)
- 9 – Antilock braking system (ABS) (yellow)
- 10 – Brake fluid level, system and reservoir pressure (red)
- 11 – Handbrake (red)
- 12 – Engine oil pressure (red)
- 13 – Battery charge (red)
- 14 – Electronic shift indicator warning
- 15 – Direct shift programme (on cars with automatic transmission) and also spare panels, e.g. for trailer flashing turn indicator repeater.

On cars with automatic transmission, the **selector lever position** is displayed on the instrument panel by a series of lights.

- P (white)
- R (yellow)
- N (green)
- D (green)
- 3 (green)
- 2 (green)
- 1 (green)

These lights are wired in an anti-glare circuit, i.e. when the main light switch is on, their intensity can be adjusted by means of the knurled disc next to the light switch. They remain on until the ignition key is turned back to position "0" or "1".

The **Service Interval Indicator** tells you when routine maintenance is due on your car, and operates when the ignition key is turned to position "2" or further.

The **green** light-emitting diodes (LEDs) go out when the engine is started. The **yellow** LED, together with the inscriptions "OIL SERVICE" or "INSPECTION", and possibly the **red** LEDs as well, come on when servicing work is due. They may come on as the car is being driven. They are cancelled by the BMW service station when the necessary maintenance work has been performed.

Refer to **Section 7** of this handbook for a detailed description of the Service Indicator.

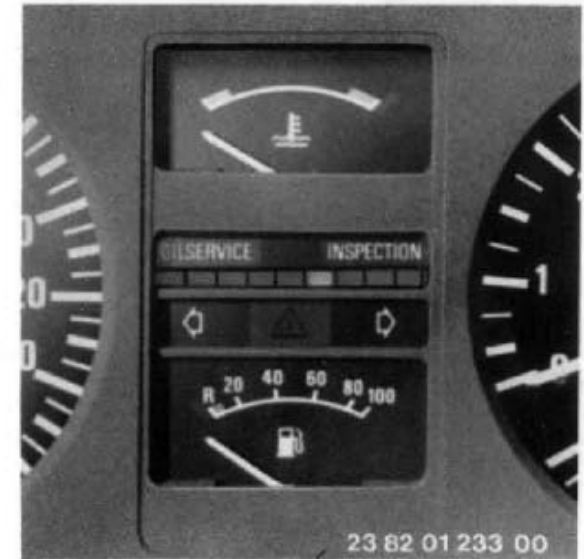
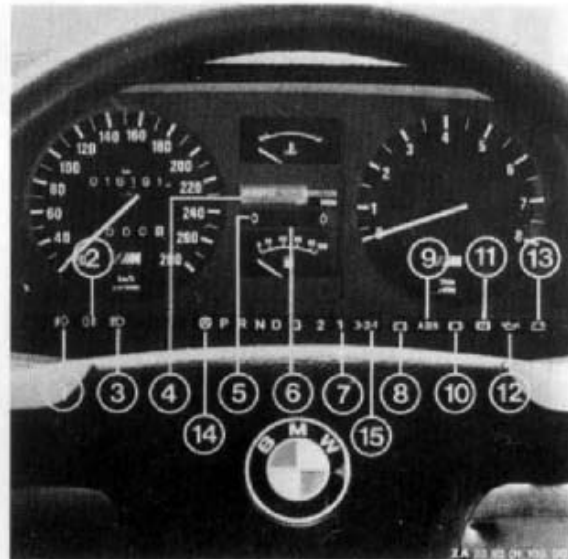

The **speedometer** contains a cumulative distance recorder to show the total number of kilometres the car has covered.

The smaller window in the speedometer dial is the **trip distance recorder**, which is used to record journeys up to 999,9 km, and can be reset to zero by pressing the knob.

A cut-out to limit maximum engine speed is provided. This takes effect when the needle of the **revolution counter** reaches the narrow red warning zone. Avoid these excessive engine speeds, particularly when driving downhill or in lower gears.

Engine speeds in the broader red zone on the **revolution counter dial** will also have adverse effects on the life of the engine, and should always be avoided.





The **coolant thermometer** has two coloured zones at the extremes of its scale.

**BLUE:** engine still cold. Drive at moderate road and engine speeds.

**RED:** engine is overheating. Stop the engine immediately and allow it to cool down until the pointer is midway between the two coloured zones. Do not open the radiator cap until then – danger of scalding. Trace the cause of overheating and have it rectified. See **Section 5**.

Needle between the two coloured zones: normal operating temperature. If outside temperatures are very high or the engine has been working very hard, the needle may approach or reach the red zone.



2-14

The **fuel gauge** in the instrument cluster shows the amount of the fuel in the tank when the ignition is switched on. If the needle is in the red warning zone and the yellow "Tank" warning light comes on, you should add fuel before completing the next 30 – 50 km. If the fuel level warning light remains on continuously, fill up with fuel at the very earliest opportunity.

To add fuel, open the **filler flap** and turn the **filler cap** counterclockwise (to the left); it has a bayonet catch. To close, replace the filler cap and turn it clockwise as far as the stop.

**Central locking system:** instructions for opening the filler cap by hand are to be found in **Section 5**.

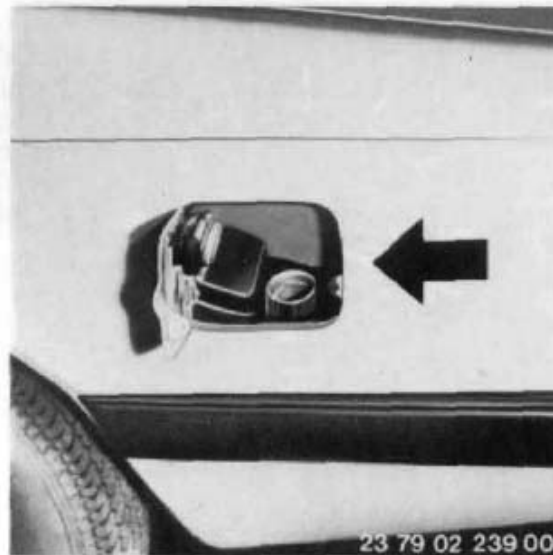

The **Active Check-Control** includes function-monitoring light-emitting diodes (LEDs) for:

- Low beam headlights
- Rear lights
- Brake (stop) lights

and fluid-level LEDs for:

- Engine oil
- Coolant
- Windshield washer

as well as one spare panel and the **test** key.

When the ignition key is turned to "1" or beyond, any reduction in engine oil, coolant or windshield washer fluid level is indicated by all inscription panels being illuminated, and the appropriate LED coming on.

With the ignition key turned to "2" or beyond, the **central warning light** on the instrument panel will also flash. At the same time, all Active Check-Control inscriptions light up, together with the "Brake lights" LED. Do not press the brake pedal first, or the brake light circuit will not be monitored automatically.

If the engine is started and the car's lights turned on, any malfunctions can be identified by means of the appropriate warning or indicating lights.

If the brake pedal is depressed, the central warning light, the "Brake lights" LED and the various Active Check-Control inscriptions should all go out if the brake lights are in proper working order.

When the car is being driven, any malfunctions of the monitored systems are indicated by the central warning light beginning to flash. At the same time, all the Active Check-Control inscription panels will light up, and the LEDs for the faulty systems.

When the **test key** is pressed, all the LEDs will come on, but when released only those indicating a genuine system malfunction will remain on, and the central warning light will go out. The Active Check-Control inscription lighting goes out after a delay.

If the engine oil level is too low, this indication remains stored in the active Check-Control until oil is added.

Any other system fault indications are cancelled by turning the ignition key to "0", but will be detected again when the ignition key is turned to "1" or beyond.

Lighting equipment defects are displayed again whenever the lights are switched on.

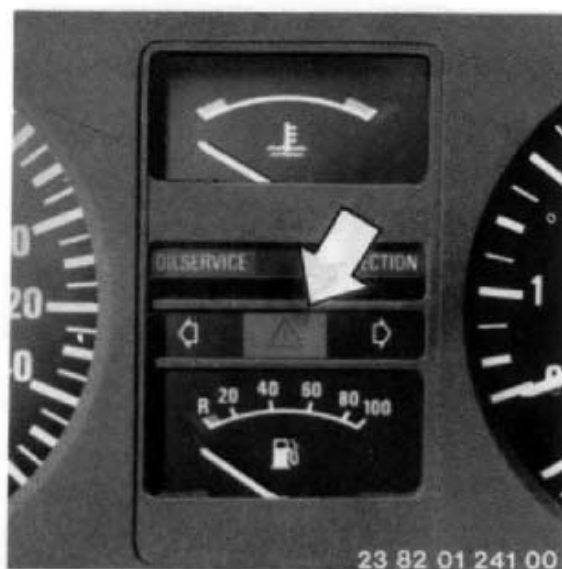

The electric **door mirror** can be repositioned horizontally and vertically by means of the mirror switch, to suit the driver's seated position. See **Section 3**.

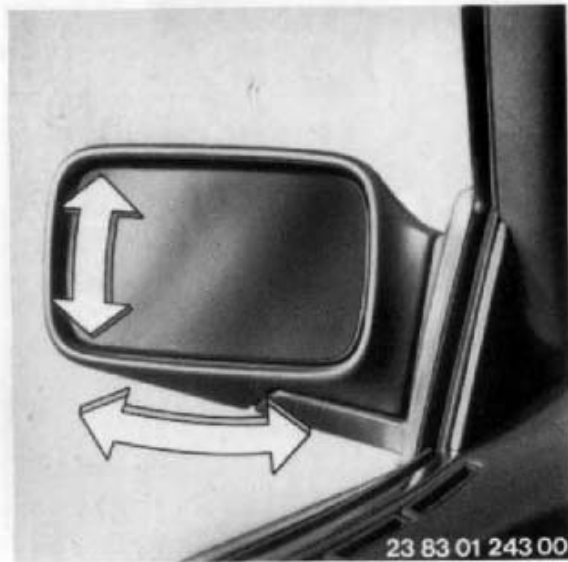

The same switch is used to adjust the passenger's side door mirror after moving the **changeover switch**.

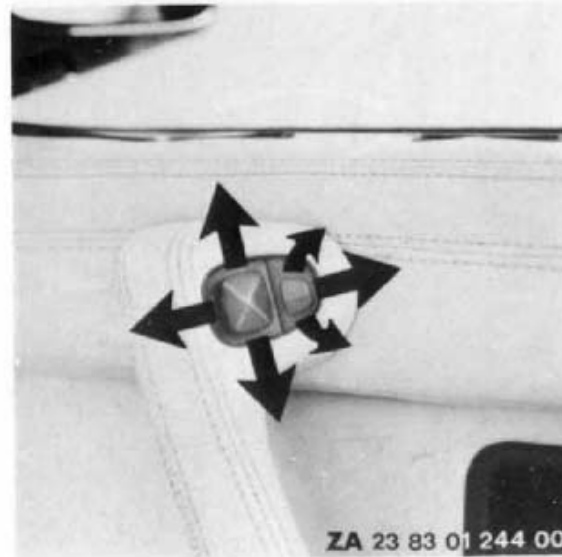

The **inside mirror** is moved to the anti-glare position by means of the small lever.



Each **sun visor** can be swung round to cover the upper part of the front side window if the sun is entering from that angle. See **Section 3**.

When the passenger's sun visor is swung down, its **make-up mirror** is illuminated if the sidelights or headlights are switched on.

The **electric window lifts** are operated from the push buttons on the central console when the ignition switch is in position **2**.

There are additional switches under the rear windows to operate them separately, but they can be isolated with the cutout button, for instance to prevent children from trapping their fingers in the windows.

An **automatic circuit breaker** protects the electric window lifts by tripping in the event of a fault or overload.

The electric window lifts are out of action when the ignition key is removed, to prevent children left in the car from operating the windows and perhaps injuring themselves.

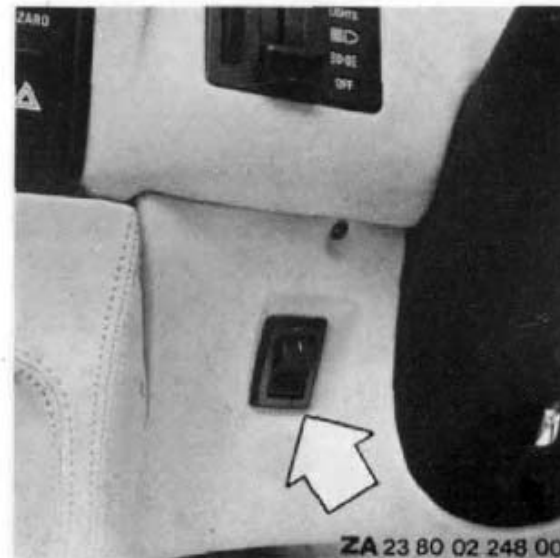
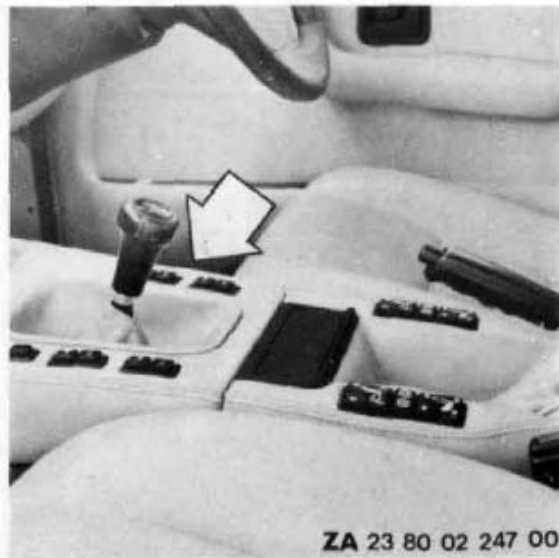

The **electric horns** are sounded by pressing the horn pushes in the steering wheel spokes.



The **rear lights** are arranged as follows:

- |   |                           |          |
|---|---------------------------|----------|
| 1 | Flashing turn indicator   | (yellow) |
| 2 | Brake (stop) light        | (red)    |
| 3 | Rear light and reflector  | (red)    |
| 4 | Reversing (back-up) light | (white)  |
| 5 | Rear fog light            | (red)    |

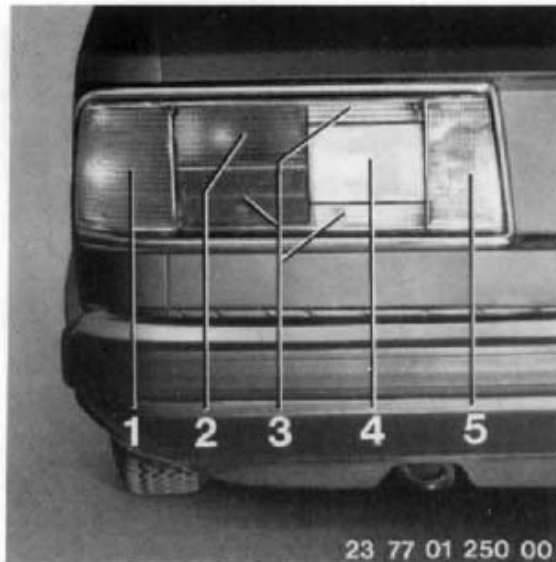

The **luggage compartment light** comes on when the lid is raised.

The **engine compartment lighting** operates when the main light switch is on and the engine lid opened.

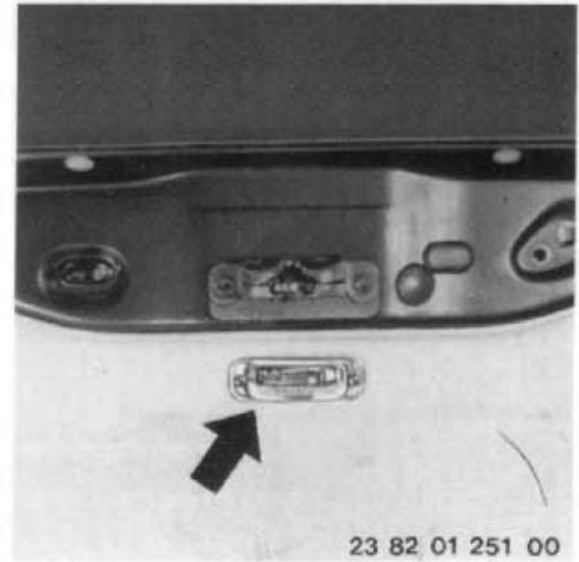



The **glove box** can be opened by pulling the recessed handle down, and closed by pushing the lid up firmly.

When the glove box lid is open, the glove box light will come on and the **rechargeable hand lamp** can be reached.

The lamp has a built-in overload cutout and can thus remain plugged in at all times so that it is fully charged whenever needed.

**Warning: Do not plug the lamp in while switched on.**

The rear seat has a **centre armrest**, which can be folded back in the seat if required.

The storage compartment in the centre armrest is used to house the first aid kit, and is opened by pressing the lock button.

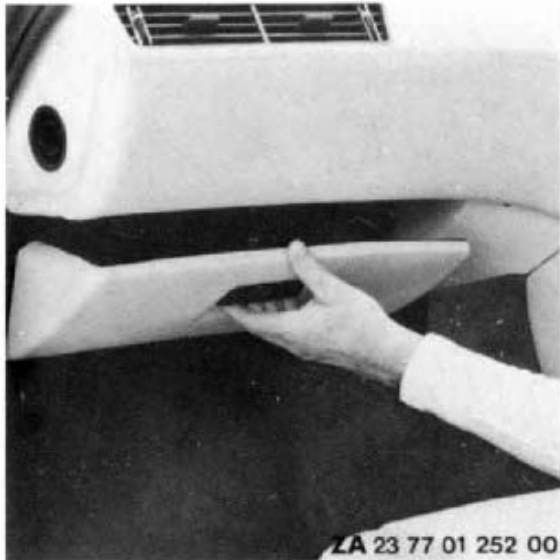

To use the **cigar lighter**, press the knob in. When the spiral element has heated up, the knob will jump out to its initial position, and the cigar lighter can then be removed.

The cigar lighter **socket** can also be used to plug in a hand lamp, electric shaver or similar appliance rated at not more than 200 watts, 12 volts. Make sure that the socket is not damaged by attempting to insert plugs of the wrong pattern.

A second cigar lighter is located in the rear heater console.

To **empty the front ashtray** at the instrument panel: pull out fully, press the leaf spring down and take out the ashtray.

To **empty the ashtrays on the rear doors**; open, and pull out upwards.

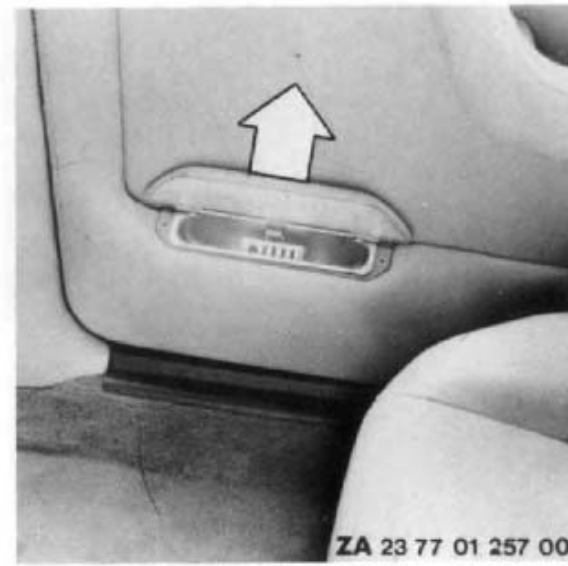

When the **heated rear** window is switched on, the green tell-tale light in the push-button with the heated rear window symbol is illuminated. See **Section 3**.

The **hazard warning flashers** are operated by the push-button with the 'triangle' symbol; its red tell-tale light flashes rhythmically when the hazard warning system is in use. See **Section 5**.

When the car's lights are turned on, a locating bulb is illuminated in the push-button switch.

Loudspeaker front/rear balance control switch.



## Gearbox

The gear lever positions for the **5-speed gearbox** are shown in the **gate pattern**.

With this gearbox the driver selects ratios 2 to 5 as on the 4-speed gearbox. The car reaches its top speed and maintains it generally in 5th gear. For fuel consumption and engine speed graphs, see **Section 6**.

All forward ratios and reverse are equipped with synchromesh.

**Note:** the position of rest of the gear lever is in the 2nd/3rd gear plane. When the lever is moved to neutral during gear shifts, it is spring-loaded to the above-mentioned planes.



ZA 23 83 01 262 00

**Reverse** should only be selected when the car is at standstill. Press the gear lever to the left until slight resistance is overcome.



ZA 23 80 01 264 00

Both **reversing** (back-up) **lights** come on when reverse gear is selected and the ignition is on.

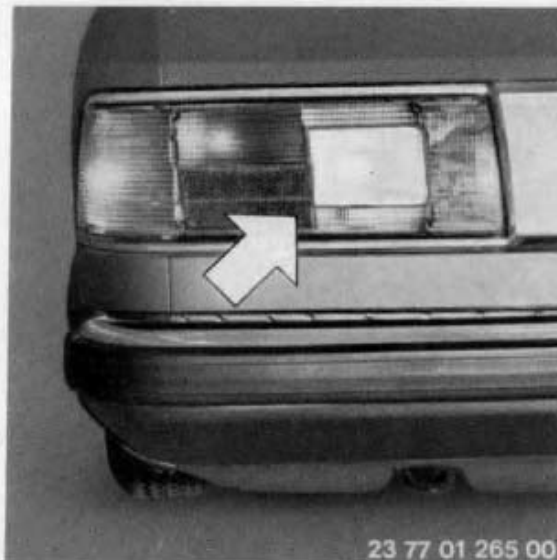

23 77 01 265 00

The **handbrake** acts on the rear wheels. To brake or secure the car, pull the lever up. To release the handbrake, pull the lever up slightly, press in the knob to release the catch and push the lever fully down.

When the handbrake is on, the **red "P" warning light** in the instrument cluster is illuminated. The bulb in this warning light can be tested by applying the handbrake.

A useful hint: press the button in as the handbrake lever is pulled up to avoid noise from the ratchet.



ZA 23 77 01 266 00



## Automatic transmission

The following **selector lever positions** are available to suit various driving requirements and road or traffic situations.

### PRND321

The position of the lever is shown by the indicating lights on the instrument panel.

With the **electronic-hydraulic transmission** the following three shift programmes can be selected in addition at the **programme switch**:

### ES3-2-1

#### P = Park

**Select only when the car is standing still.**

The rear wheels are locked in this position as an additional safeguard against the

parked car rolling away. Press the release catch under the selector lever handle to move the lever to this position. The engine can be started. To select the desired speed range, press the release catch again and move the lever back.

#### R = Reverse

**Select only with the car standing still and the engine idling. First pull up the release catch below the lever handle. Wait for reverse to engage (slight jerk) before accelerating.**

**Important: if reverse were to be selected with the car moving forwards, the rear wheels would lock and cause an accident.**

#### N = Neutral

No connection between engine and transmission. The engine can be started.

Select this position during **lengthy stops** (for example in traffic jams) to prevent the engine from overheating unnecessarily.

To avoid increased clutch-plate wear, this position should be selected when the car is in motion only when absolutely necessary, e.g. in a skid.

At short stops, for example when waiting at traffic signals, the drive positions should be left in engagement.

#### D = Drive (automatic gear selection)

This is the position for all normal driving. The car starts in 1st gear and shifts up automatically to 2nd, 3rd and 4th. The shift points have been chosen for maximum economy. In the 4th speed range, the **converter lockup clutch** engages automatically, depending on the accelerator position and speed, and thus creates a mechanical link between the engine and transmission.

The 4th gear is an overdrive ratio. At any given road speed, it reduces engine speed, engine noise level and fuel consumption. The maximum speed is normally reached and maintained in 3rd gear. If the kick-down is operated in 3rd gear (accelerator pedal depressed beyond the normal full-throttle point), the transmission will not shift up to 4th gear even if the selector lever is at D. The car can then be accelerated in 3rd gear up to its maximum speed. 4th gear will engage when the accelerator pedal is eased back sufficiently.

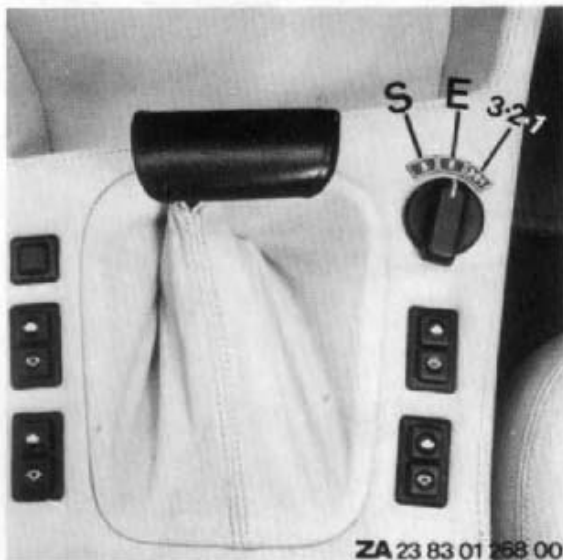

If the accelerator pedal is again depressed to the kick-down position or the selector lever moved from D to 3, the transmission will shift down from 4th to 3rd gear immediately, regardless of road speed.

### **3 = Direct drive position**

You are recommended to select this position if the car has to be started and stopped frequently (heavy traffic, town driving), to avoid frequent shifts between 3rd and 4th gears. Only gears 1 to 3 will then be selected automatically.

### **2 = Hill climbing and engine braking**

This position may suit the driver better on mountain roads or very long uphill and downhill gradients. It makes better use of the full engine performance and the engine's braking effect.

### **1 = Steep hill climbing and engine braking**

This position provides for the rare occasions on which the driver prefers to remain in 1st gear, for instance on very steep uphill or downhill gradients.

Positions 2 and 1 can be selected at any speed, after releasing the safety catch under the handle. However, the transmission will not shift down immediately into 2nd and 1st if this would cause engine overspeeding, but only at the following speeds:

BMW 745iA – app. 145 and 85 km/h

Note that once 2 or 1 have been selected, the transmission does not shift up to a higher gear, even if this means that the engine may overspeed.

**Important:** after selecting any speed range from neutral, wait for the transmission to engage (slight jerk and drop in engine speed) before accelerating.

### **Kick down**

After the full-throttle position has been reached, the accelerator pedal on automatic-transmission cars can be depressed further by overcoming a detent.

This selects the next-lower speed range immediately, up to a quite high road speed, so that maximum acceleration is always available when needed (for example when overtaking).

The next upward shift does not then take place until a very high engine speed has been reached.

For towing away, tow-starting and starting with a flat battery, see **Section 5**.

### **Programme switch for electronic-hydraulic transmissoin**

#### **E = Economy programme**

Once the car has been started, this programme can be selected for low-consumption motoring. The converter lockup clutch engages automatically in 3rd and 4th gears.

#### **S = Sports programme**

This is the programme for an enthusiastic driving style. The gear shift points are delayed to make full use of the car's power reserves. The converter lockup clutch engages automatically in 3rd gear. 4th gear is locked out of use.

### **3-2-1 = Direct shift programme**

This programme is for single-gear driving. The gear selected is also used for pulling away. For example, if the selector lever is in position 1 for tackling steep gradients or when towing a trailer, no undesirable gear shifts will be made. The same applies to driving on icy roads in winter: with the selector lever in position 3, you will be able to pull away smoothly, and no gear shifts will be effected.

The **green tell-tale lamp** in the combined instrument display indicates that this programme is selected.

The **yellow tell-tale lamp for the shift electronics** goes out when the engine is started.

### **Automatic cruise control**

To reduce driving effort, particularly on long journeys, any desired speed can be maintained and stored in the cruise control memory. The device operates from 35 km/h.

The selector lever, in front of the wiper/washer lever, has four positions.

Moving to:  
"CONST".

Speed is held and stored.

Holding the switch in this position accelerates the car without touching the accelerator pedal. When the switch is released, the speed reached at that moment is held and stored.

The cruise control cuts out when the brakes are applied, when the transmission selector lever is moved from D to N, if the car's actual speed varies by more than  $\pm 30$  km/h from the stored setting, if the clutch pedal is depressed, and if the switch is moved to "off".

If the accelerator pedal is pressed down, for instance to overtake or on a long gradient, the stored speed will gradually be regained and held afterwards.

#### "RESUME"

A previously stored speed can be obtained again.

#### "OFF"

The cruise control is put out of action by moving the lever either up or down.

**Note:** You can put the automatic cruise control out of action at any time by operating its switch, regardless of the road or traffic situation or the car's speed.

The last stored speed setting is not cancelled until the ignition is turned off (key at position 1).

#### Never use the automatic cruise control if:

- you are in heavy traffic
- the road is winding where a constant speed cannot be maintained
- the road surface is slippery - **rain, snow, ice**
- the road surface consists of a loose driving surface - **gravel, dirt, sand.**

#### Steel-panel sliding roof

The steel-panel sliding roof which can be specified as an option on your BMW can not only be slid back but also raised at the rear to provide more intensive ventilation of the car's interior.

The roof is electrically operated, pressing the rear push button = lowering or opening (sliding back), pressing the front button = raising the rear end of the panel or closing the roof (sliding, forwards).

In this case, sliding and elevating operations are separated by a built-in electrical change-over switch. After the roof has been shut, the driver motor will cut out automatically. If the roof is to be raised at its rear end immediately after sliding closed, the switch must be pressed a second time. The same applies when changing over from lowering to sliding open.



Before leaving the car, switch off the electric sliding roof mechanism by taking out the ignition key. This will prevent children left in the car from tampering with the controls and possibly incurring injury.

If the electrical system should fail, the steel-panel sliding/vent roof can be closed manually. See **Section 5.**

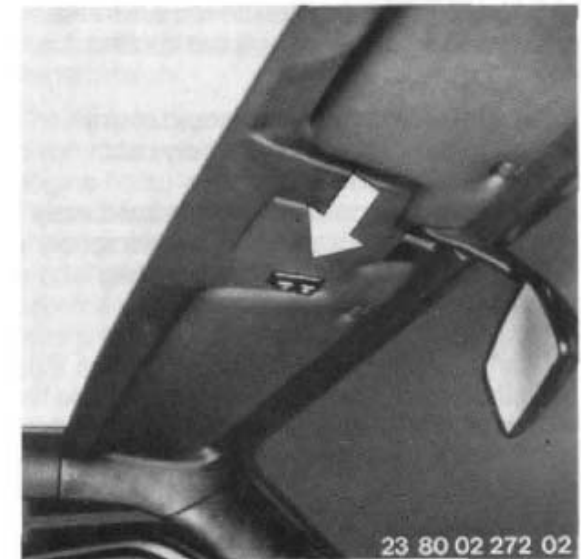



# Heating and ventilation

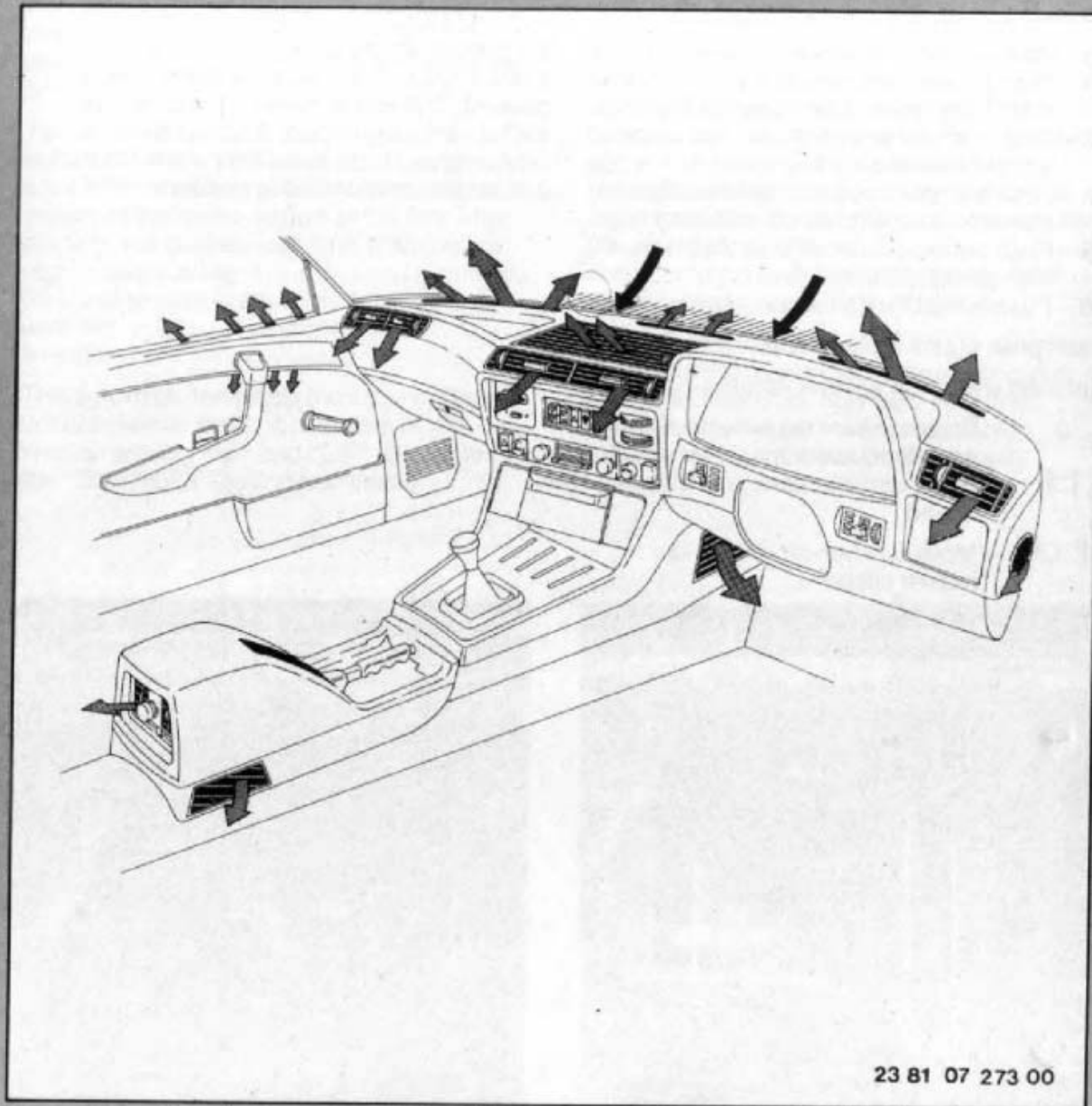

Heater and ventilation  
system  
Air-conditioning  
Air distribution  
Automatic control of air-  
conditioning system

23 81 07 273 00

The **heating and ventilation system** is noted for high performance, great sensitivity of control, the provision of stratified interior temperatures and rapid response from cold. The comprehensive control system enables the climate inside the car to be ideally matched to the occupants' wishes.

The **Programmed climate control** regulates the desired temperature inside the car and controls airflow volume and distribution automatically in accordance with climatic and ambient conditions. Normally speaking no manual resetting of the controls will be necessary. However, the automatic system can always be overridden to obtain specific settings as desired by the driver or passengers.

The controls, switches and interior temperature sensor are arranged as follows:



- 1 – Airflow volume (knurled wheel)
- 2 – Temperature (knurled wheel)
- 3 – Temperature sensor
- 4 – Push button – rear-seat air distribution
- 5 – Push button – recirculating air
- 6 – Push button – upper and lower air distribution without air-conditioning
- 7 – Push button – automatic air distribution without air-conditioning
- 8 – Push button – upper, centre and lower air distribution with air-conditioning
- 9 – Push button – automatic air distribution with air-conditioning.
- 10 – Push button for de-icing windows.

Each push button has its own tell-tale lamp.

#### Knurled wheel for airflow volume (1)

- 0 – Fresh air from outside, heating and air-conditioning switched off
- Slight ram air intake, low blower speed
- Moderate ram air intake, low blower speed
- Maximum ram air intake, low blower speed

When the knurled wheel is turned to the wedge-pattern marking, the blower speed is controlled automatically in relation to the required heating or cooling output in order to improve airflow through the car and ensure that the necessary volume of air is present. The knurled wheel can be turned further to the right as far as maximum blower speed (right-hand limit) if it is felt that a more powerful airflow is needed.





### Knurled wheel for temperature (2)

An interior temperature between 16 and 28 °C can be selected. The scale should be regarded as an approximate guide when obtaining a pleasant temperature inside the car.

Temperature is regulated electronically by a sensor behind a perforated cover for the car's interior and an outside temperature sensor in the intake airflow at the fan. After starting, the desired setting is obtained as rapidly as possible; it is increased slightly by the outside temperature sensor in cold weather, and reduced slightly in hot weather.

The automatic temperature control system is out of action at the limit positions of the knurled wheel ("16" and "28") and when the "DEFROST" button is pressed.



We recommend the following choice of programs:

### "INT AIR" (SMOG) (3)

**This is ideal if an objectionable smell enters the car.** It switches the air-conditioning over to the air already inside the car, with only a slight proportion of fresh air, so that impure or objectionable air (exhaust, smoke, etc.) cannot enter in any significant quantity. Air distribution is as with the automatic programs. The air-conditioning is switched on to improve the quality of the air (moisture extraction).

When the recirculated air setting is selected, or the controls reset to a fresh-air program, interior temperature may vary for a short period, but is not normally necessary to reset the temperature control manually.



### "HEATING, UPPER/LOWER" (4)

**For use in cool or cold weather when no outside airflow is required.**

The air-conditioning system remains switched off. Most of the airflow is distributed to the footwells.

### "HEATING, AUTOMATIC" (5)

For cool and fairly cold weather, when the air-conditioning is not needed.

The air-conditioning remains switched off. Air distribution is controlled automatically so that in cold weather the heated air is supplied mainly to the footwells, and air emerges from the outlet grilles if the weather is warmer.

### Push button "REAR" (rear seat area) (6)

Pressing the button opens the air outlet to the rear seat area unless the "DEFROST" button has been pressed or the knurled-wheel airflow control is at "0".

For optimum response to weather conditions, various functions can be selected at the push buttons. Apart from the rear-seat area button, only one button (one program) can be selected at a time.

### Interior temperature sensor (7)

This is located behind the perforated panel.

### **"MAX. AIR-CONDITIONING" (8)**

**For rapid cooling of the car's interior in hot weather.**

Above 1 °C outside temperature the air-conditioning operates all the time. The air is cooled, dried and heated according to ambient temperature conditions. All the front air outlets are open, so that this program enables the front footwells to be cooled as well.

### **"AUTOMATIC AIR-CONDITIONING" (9)**

**This is the generally recommended setting, particularly in cool to warm weather and when atmospheric humidity is high.**

Above + 1 °C outside temperature the air-conditioning operates all the time. The air is cooled, dried, heated in accordance with the ambient temperature and distributed automatically. This program prevents the windows from steaming up in almost all driving conditions. If it is to operate effectively, however, not all the air outlet grilles should be closed at the same time.

### **"DEFROST" (10)**

**For maximum window defrosting and drying steamed-up windows.**

The air is heated to maximum temperature automatically, the blower runs at high speed and air emerges only from the defrosting outlets. At outside temperatures above + 1 °C the air is dried by the air-conditioning system, which is run as necessary.

#### **Important notes:**

**1. The air-conditioning operates only when the engine is running.**

For maximum cooling effect when using recirculating air, only a slight amount of fresh air is permitted to enter. This operating mode is indicated by the lamp above the "INT AIR" (SMOG) button.

When the "RECIRCULATING AIR", "HEATING, UPPER/LOWER/AUTOMATIC" and "AIR-CONDITIONING, AUTOMATIC" programs are in operation, the blower is switched off at low outside temperatures initially (unless the blower control is at its maximum setting) until the engine coolant has warmed up slightly. To prevent unpleasant draughts, the ram air is diverted to the windshield.

When an automatic program with automatic ventilation control is being used, a pleasantly stratified temperature gradient inside the car can be obtained by adjusting the air outlet grilles, so that the head area is cool and the footwells warm.

**2. The air-conditioning must be run at least once a month for a short period by switching it on at program buttons 5, 8, 9, or 10 when the outside temperature is above +5 °C. This is important in the cold season of the year particularly, to prevent the compressor shaft seal from drying out and allowing refrigerant to leak out.**

**3. If any fault in the air-conditioning system is suspected, please take the car to a BMW service station qualified to work on air-conditioning systems at once.**



The pictures of the front and rear outlets show the range of settings.

The grille on the top of the instrument panel is fixed, for indirect centre ventilation, and can be closed by turning the knurled disc on the left to the rear.

Defroster vents, front door and side window heating as well as footwell outlets are fixed in position.

The outlets above the controls and on the left and right of the facia can be moved horizontally and vertically and closed by turning the side knurled discs downwards.

The outlets at the rear are fixed to ventilate the lower part of the footwell. The rear grilles can be moved horizontally and vertically. The outlet can be adjusted upwards or downwards by means of a sliding control and can be closed by pressing the button on the instrument panel for air distribution to the rear.

By pressing the desired push buttons, air can be distributed inside the car to suit all the occupants' requirements.

The air outlet grilles are normally supplied with slightly cooler air so that a pleasant, stratified airflow is obtained through the car.

#### **Air extraction**

Stale air leaves the car's interior through slots below the rear window and emerges at openings in the rear roof pillars.

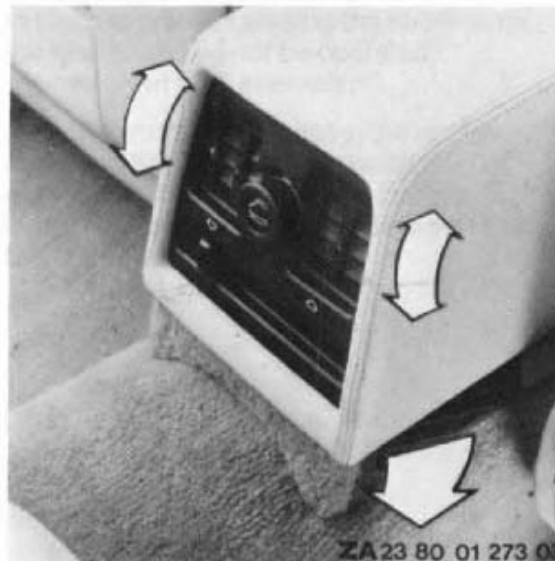
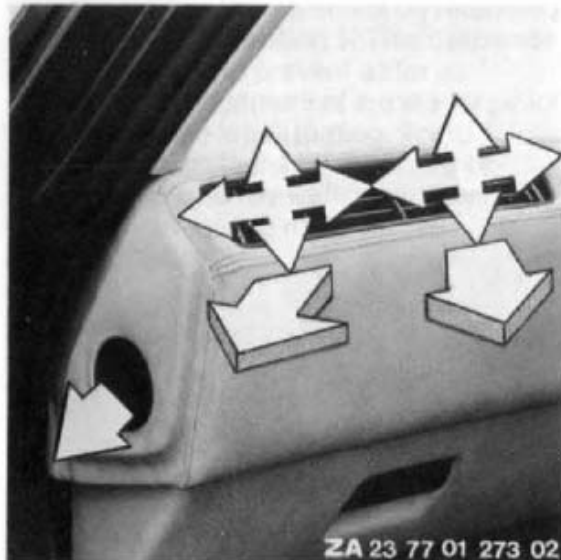

## For personalized equipment on your BMW

### **Car radios**

Specially recommended: the new generation of BMW-approved car radios in stereo and with a built-in cassette recorder.

### **BMW floor mats**

For front and rear, accurately fitting and anti-slip – protect yet look attractive at the same time. Velour carpet, hard-wearing synthetic carpet or rubber mats to choose from.

### **BMW trailer coupling**

For caravans, boat trailers or horse boxes. Available with detachable ball head.

### **BMW mudflaps**

These identify the fast BMW driver as considerate when overtaking, and protect his own car against dirt and flying stones.

### **BMW first-aid kit**

Available in a box. On your model the first-aid kit can be housed in the rear-seat centre armrest compartment.

### **BMW gear lever knob**

An attractive accessory, in fine wood with recessed BMW badge.

### **BMW Child Restraint Systems**

Seat for children from sitting-up age to a maximum of 18 kg mass and 105 cm tall.

#### **“Junior” Restraint System**

Consisting of child's braces-type automatic belt and seat shell. With seat shell for small children – about 3-8 years; without seat shell for larger children up to a maximum of 36 kg mass, then securing with adult's seat belt.

Pictures and details under “SAFETY”.

### **Other items from the Genuine BMW Automobile Accessory Range**

BMW paint and touch-up sticks, spare bulb box, hand lamp with or without lead, rear loud-speakers, safety sports steering wheel, sports seats, sports mirrors, warning triangle.

#### **Please note:**

Depending on which BMW model you drive, some genuine BMW accessories may be part of the car's standard equipment. In addition, certain items from the list are not suitable for, or permitted on all BMW models. Your BMW dealer will gladly advise you and show you the latest items in the Genuine BMW Accessories range.



## Starting off

Before you operate the starter, always make sure that the gear shift lever is in neutral.

On cars fitted with automatic transmission the engine can only be started when the selector lever is in the "P" or "N" position.

**Let the starter run long enough to start the engine.** Turn the ignition key clockwise to position **3** until the engine fires. Do not allow the engine to turn over without firing for longer than about 20 seconds. When the ignition key is released it will spring back automatically to position **2**. When a cold engine is started in this way, it will run at a relatively high speed until warm.

To make starting easier, particularly in freezing conditions, switch off all current-consuming items and possibly also press down the clutch pedal.

If the starter has to be operated a second time, the ignition key must first be returned past position **2** to position **1**. This deliberate delay is included to prevent as far as possible re-engagement of the starter pinion while the engine is still turning. Try to prevent damage to the flywheel ring or starter pinion teeth by waiting until the engine has ceased to rotate before operating the starter.

In very severe frost, protect the battery by limiting the first starting attempt to about 20 seconds. Before trying a second time, wait about 20 to 30 seconds to permit the battery to recover. The second attempt should not be much longer than the first.

**The fuel injection engine of your BMW** is fitted with an automatic cold starting and warming-up unit. Please note the following starting instructions.

**The accelerator should not normally be depressed when starting the engine.**

If the engine does not start at the first attempt, for example if it is very cold or very hot, depress the accelerator half way when trying to start.

To aid the starting procedure, a quantity of extra fuel (governed by coolant temperature) is injected into the intake pipe. In order to prevent wetting the spark plugs, the starter should not be operated repeatedly at brief intervals.

After the warming-up phase, the engine returns to its normal idling speed automatically, as soon as the coolant temperature indicator points between the two coloured zones.

After the engine has been started the **warning and tell-tale lamps for battery charge, oil pressure and brake pad wear should go out** and you can move off at a moderate engine speed.

**Preparing to move away with automatic transmission:**

With the engine idling, the selector lever can be moved from **P** or **N** to one of the drive positions. **The brakes should be kept applied.**

Wait until a slight jerk indicates gear engagement before accelerating.

**Stopping the car (with automatic transmission):**

When the car has been stopped with the brakes, or before it is driven away, it will tend to creep forward on a flat surface when a gear is engaged. Keep the foot brake applied lightly to prevent this.

To **stop the engine**, turn the ignition key back to position "1".



## On-board computer

As its basic function, the **on-board computer** shows the time with the accuracy of a quartz clock.

If four decimal points only flash (no figures) when a button is pressed (apart from TIME) this means that the electrical circuit has been interrupted, for instance by removing or disconnecting the car's battery, and that the correct time must first be reset. After this, the remaining functions of the computer can also be operated again.

### Note: all keys have two functions.

Before a numerical value input is made, the key marked with the desired function must be pressed. After the input, wait for the digital display to go out briefly (approx. four seconds). The input value has then been accepted by the computer, which is ready for further inputs or outputs.



## Changeover switch km/miles

The digital display can be either in metric units or in Anglo-American units.

Note: AM = forenoon (ante meridian), PM = afternoon (post meridian).

### Key "TIME/LOCK"

**TIME:** For resetting or correcting the time readout, press the key repeatedly until a zero is displayed at the far right, then press the keys for the correct time in the order the digits normally appear. Wait for the digital readout to go out briefly, then start the clock (for instance when a radio time signal corresponding to the input setting is heard) by pressing the "START" key. When the ignition is at "0", you can obtain a time display by pressing the TIME key.

**LOCK:** In addition to the time, any other desired display can be held by pressing this key. No other numerical inputs are then possible. The green indicating lamp at the right of the key will light up. To revert to the normal time display, press the key again.

### Key "CE/START"

**CORRECTION:** This cancels the incorrect input but retains previous values.

**START:** This sets the stopwatch timer in motion and the green indicating lamp at the left of the key lights up.

The readout is in seconds and tenths; after one minute it switches to minutes and seconds, and after one hour to hours and minutes.

After eight seconds the display reverts automatically to real time, but the stopwatch timer continues to run and can be displayed for eight seconds at a time by pressing the key. Press "LOCK" for an uninterrupted elapsed time display.

### Key "0/STOP"

This halts the stopwatch timer; the final time is displayed for eight seconds.

**To recall** a previously measured time from the stopwatch timer, press the key again.

**To cancel** an input or a function, first press the corresponding input/function key, then press the "STOP" key. The indicating lamp will go out.

### Key "1/TEMP"

**To check outside temperature;** the red indicating lamp at the left of the key lights up or flashes for eight seconds at temperatures below + 3 °C.

Regardless of the function being displayed at the time, a chime signal is sounded when the temperature drops below 3 °C, the indicating lamp begins to flash and the actual temperature is faded up for eight seconds.

This also applies when the ignition key is turned from "0" to "1" and the temperature is under 3 °C.

### Key "2/ARR"

To obtain probable **time of arrival** during a journey after supplying the computer with the total journey distance by pressing the "DIST" key. Display is retained for eight seconds.

### Key "3/SPEED"

A **maximum desired road speed** input can be supplied to the computer. The red indicating lamp at the right of the key will light up. A chime signal and flashing indicating lamp then warn the driver if he exceeds the desired speed.

To obtain average speed since the **"SPEED"** and **"START"** key were pressed in that order, press this key again. Display appears for eight seconds.

To cancel the speed warning, press **"SPEED"** and **"STOP"** in succession.

#### Key "4/MPG"

To input an average rate of fuel consumption to the computer; the red indicating lamp at the left of the key will light up.

To obtain average fuel consumption since pressing the **"MPG"** and **"START"** keys; the display appears for an eight-second period. Below a road speed of 20 km/h, four decimal points flash instead.

To cancel the fuel consumption warning: press the **"MPG"** and **"STOP"** keys in that order.

#### Key "5/RANGE"

To obtain **probable range** with fuel remaining in tank. Display appears for eight seconds. If range is less than 15 km, four decimal points flash.

**Warning:** correction is needed after battery has run down. Run the tank until almost empty low fuel level warning light **remains on continuously for at least 3 km**. After filling the tank, the display will again be correct.

#### Key "6/EXIT"

For input of an **intermediate journey target** in km or miles, e.g. a particular freeway or similar main road exit. Maximum distance 999 km, the green indicating lamp at the

right of the key lights up. A short distance before the target distance is reached, a chime signal sounds, after which the green indicating lamp flashes until the remaining distance has been covered.

To obtain a readout of the **remaining distance** to the intermediate journey target; display appears for eight seconds.

To cancel the intermediate target reminder; press the **"EXIT"** and **"STOP"** keys in succession.

#### Key "7/TIMER"

Input of a time at which (for example) the independent heater should be switched on (optional extra). The green indicating lamp at the left of the key lights up. It goes out if the ignition is turned to "0". After the heater has been switched on, the indicating lamp flashes during the 30-minute operating period, after which the heater is switched off.

Direct switching on or off is achieved by pressing the **"START"** and **"TIME"** keys in succession. If the car does not have an independent heater, this function is used to sound an alarm chime at the programmed time.

To obtain a display of the **programmed time**; display appears for eight seconds.

To cancel a programmed time, press the **"TIMER"** and **"STOP"** keys in succession.

#### Key "8/DIST"

Input of a target distance (max. 9999 km), so the arrival time can be obtained by pressing **"ARR"**.

To obtain the **remaining distance** from the

end of the journey: display appears for eight seconds.

To cancel the distance memory, press the **"DIST"** and **"STOP"** keys in that order.

#### Key "9/CODE"

**Input** of any code number with the ignition key at "1". Turning to "2" cancels the input, turning to "0" stores it and activates the anti-starting device. The green indicating lamp next to the key lights up, but goes out when the ignition is at "0". When the key is next turned from "0" to "1", the on-board computer displays "0000" and the green indicating lamp is on. After the code number input has been supplied, the anti-starting device is released, the display shows real time and the indicating lamp goes out.

If an incorrect input is supplied three times in succession, or an attempt to start is made three times when the computer has been supplied with incorrect information, an alarm will sound for 30 seconds, but the anti-starting device will remain active.

To cancel a code number input before turning the ignition key from "1" to "0": press the **"CODE"** and **"STOP"** keys in that order.

# BMW CAR RADIOS

Bavaria Electronic

General notes on car radio and  
cassette-player operation

Warranty and exchange terms

Exchange check



ZA 23 83 01 270 00



## Bavaria Electronic car radio

The Bavaria Electronic car radio has a digital display panel, and also offers the following control and features:

- SW, MW and FM radio reception
- Waveband selector keys and 4-station recall keys per waveload selector key
- Manual tuning
- Automatic station finder
- Tone control Bass and Treble tone Controls
- Town/Country key
- Mono/Stereo cassette player with automatic reverse
- Dolby noise-reduction key
- Speed-dependent volume control

- 1 - On/off switch and volume control
- 2 - Station recall keys
- 3 - Waveband keys
- 4 - Town/Country key
- 5 - Dolby key
- 6 - Sensitivity switch
- 7 - Automatic station-finder key (from lower to higher frequency)
- 8 - Manual tuning control
- 9 - Automatic station-finder key (from higher to lower frequency)
- 10 - Digital tuning (station frequency) display
- 11 - Tone controls
- 12 - Cassette eject key
- 13 - Fast forward key
- 14 - Cassette slot
- 15 - Rewind key
- 16 - Track selector key
- 17 - Fine tune display

### On/off switch (1)

The knob is turned to the right to switch the set on and increase the volume, and to the left to reduce the volume; when turned fully to the left, the set is switched off.

### Tone controls (11)

The quality of reproduction can be varied to suit personal listening tastes by altering the lever settings:

- |        |          |   |          |
|--------|----------|---|----------|
| Treble | to right | = | increase |
| Treble | to left  | = | decrease |
| Bass   | to right | = | increase |
| Bass   | to left  | = | decrease |

Both levers have a central detent position representing the normal treble and bass settings. The lever apertures are illuminated so that the settings can be seen after dark.

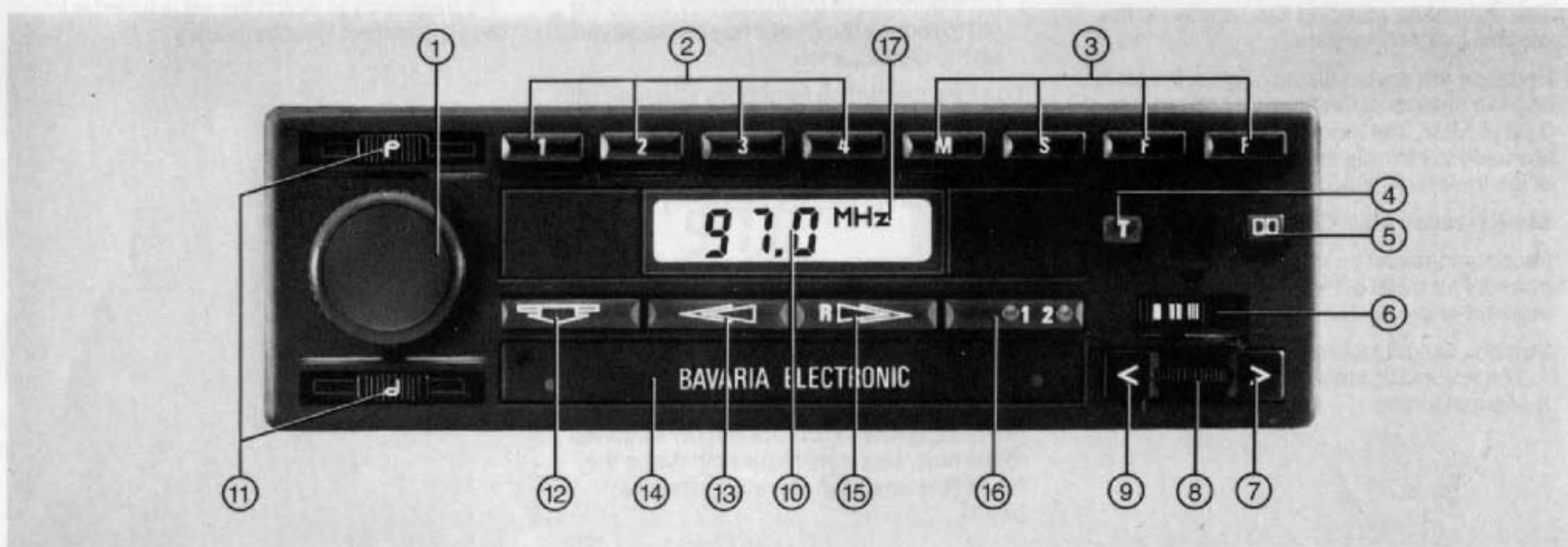

### Manual tuning control (8)

Turn the knurled wheel to retune to a different station manually.

### Digital tuning (station frequency) display (10)

The digital display shows the frequency of the station to which the radio is tuned.

For FM stations, tuning is in 0,0215 MHz steps, with the display in 0,1 MHz steps as represented by the detents of the knurled knob.

For medium-wave and short-wave stations, both display and tuning are in 1 kHz steps, as represented by the detents of the knurled knob.

### Waveband selector key (3)

Press the appropriate key for medium-wave, short-wave or FM (VHF) reception.

The waveband selected can be seen in the window below after dark.

Because the lowest display digit is 0,1 MHz and the detents of the knurled knob represent 0,0215 MHz, fine tune display segments (17) are used to indicate in which half (0,05 MHz) of the lowest display digit the set is tuned.

### Station recall keys (2)

Four stations can be stored in the set's memory for each of the wavebands: FM, medium-wave and short-wave.

Stations can be located and memorized by:

1. The automatic station finder
2. Manual tuning

### Before memorizing, the correct waveband must be selected by pressing one of the waveband selector keys.

1. When using the **automatic station finder**, the **right key (7)** is pressed to ascend the frequency scale, and the **left key (9)** to descend the frequency scale.

A three-position **sensitivity control** can be used to vary the number of more distant stations which the automatic station finder detects:

- I = powerful stations only
- II = average-strength and powerful stations
- III = all stations, including weak signals

The setting of **sensitivity switch (6)** can be seen in the illuminated window after dark.

2. If using the **manual tuning control (8)**, the knurled knob must be turned to the right to increase the frequency and to the left to reduce the frequency as displayed on the digital panel.

To **store** the station frequency obtained with the automatic station finder or the manual tuning control, press a convenient station recall key and keep it pressed until the digital displays shows the new frequency you wish to store.

The station is now memorized, and can be listened to again at any time by pressing first the correct waveband key and then the station recall key previously used.

The station previously selected will first be heard, and its frequency shown. After this, the radio is muted and the display switches to the new, selected frequency. When the key is released, the new station can be heard.

If the station recall key is used to store a new frequency, the previously memorized frequency will be erased.

The window below the station recall key is illuminated so that the key can be located in the dark.

**Important:** if the car's battery is disconnected, the stations memorized by the radio will be lost.

Before you store a station it is recommended that the frequency be compared to the chart at the back of this book for origin and accuracy.

### Town/Country key (4)

This key reduces the sensitivity of the tuner when depressed. It is recommended that it be depressed when operating the set in areas of high signal strength, e.g. near the transmitter. It can also be used to verify that the frequency to which the set is tuned is in fact the correct local frequency.



### Dolby switch (5)

To replay cassettes recorded by the Dolby noise reduction system, the Dolby switch should always be pressed. This cuts tape hiss and makes treble reproduction more brilliant. The signal which appears in the window below the switch indicates that it is pressed (Dolby circuit in use).

**Warning: Always switch off the radio before any work is undertaken on the car's electrical system.**

### Cassette replay

Switch on the radio and insert the cassette fully into **slot (14)** with empty spool leading. The radio will switch over automatically from radio to cassette replay.

Press the **fast forward (13) or rewind (15) keys**, which have detents to hold them in, until the desired point on the tape is found. To stop fast forward or rewind movement, press the other key briefly. At the end of the tape, the key is automatically released.

If the **track selector key (16)** is pressed, the other track on the tape will be played. This can take place at any point during cassette replay. The light-emitting diodes in the key indicate which of the two tape tracks is being heard.

At the end of tape replay, the cassette replay mechanism switches over automatically to the reverse track.

The **cassette eject key (12)** can be pressed at any time. The cassette is then partly ejected from the slot and the set switches from cassette replay back to radio.



### Back of radio

- 1 – Connection for automatic speed-dependent volume control
- 2 – Antenna connection
- 3 – Radio mounting
- 4 – Fuse holder (4 A, slow-acting)
- 5 – Right loudspeaker (black)
- 6 – Left loudspeaker (white)

- 7 – Negative (earth/ground) connection
- 8 – Positive (+) connection
- 9 – Radio lighting
- 10 – Connection for automatic-retracting antenna
- 11 – Connection for station memory (positive)
- 12 – Switch for speed-dependent volume control; positions:
  - 1 = 6 db louder above 140 km/h
  - 2 = 7 db louder above 160 km/h
  - 3 = 8 db louder above 180 km/h

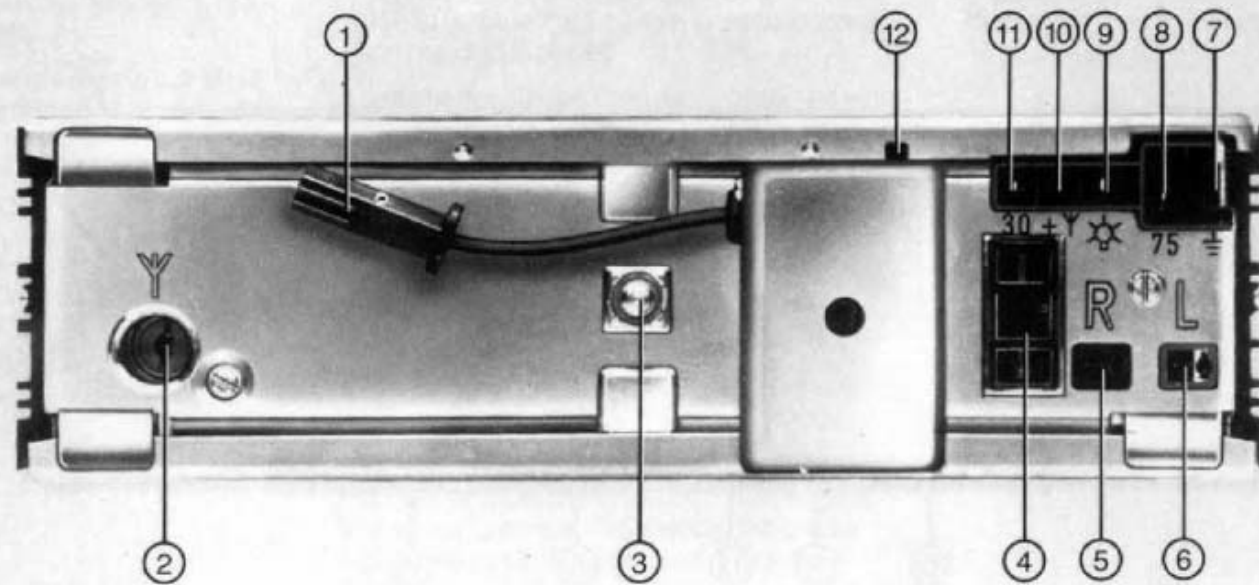

## Technical data

Output power at 14 V	1 x 14 W on 4 $\Omega$ at 1% T.H.D. 2 x 18 W on 4 $\Omega$ at 10% T.H.D.
Operating voltage	10,8 15,6 V
Testing voltage	13 $\pm$ 0,26 V
Negative to chassis	> 10 mA up to 4 A, according to volume setting
Tone control	Bass $\pm$ 12 db (100 Hz). Treble $\pm$ 12 db (10 Hz)

### Radio section

FM	87,518 108,072 MHz, 21,5 kHz per step
SW	5,949 6,201 MHz
MW	509 1621 kHz
IF	AM 455 kHz, FM 10,72 MHz low side
Frequency response	40 Hz 12,5 kHz

### Cassete section

Tape speed	4,76 cm/s
Deviation of tape speed	$\pm$ 1,5% max.
Wow and flutter	$\pm$ 0,3% weighted
Tape	Compact cassette C60/C90 metal capable.
Frequency response	40 Hz 12 kHz ( $\pm$ 3 db) normal 40 Hz 14 kHz ( $\pm$ 3 db) metal
Signal to noise ratio	61 db (Dolby in) 53 db (Dolby out)
Fast forward/rewind time	130 secs approx (C60)

This radio is designed in accordance with S.A.B.S. specifications in respect of low side IF oscillator and 86 kHz channel spacing.

**BMW cassette radios with tape reverse** can play the tape in either direction, so that the cassette does not have to be removed, turned over and inserted again to play the second side. At the end of the tape, the cassette player switches over automatically to the second track.

The cassette players can replay ferrous oxide, chrome dioxide and ferrochrome tape grades satisfactorily.

We recommend the use of **C 60 SM cassettes** in BMW cassette radios; these play for 2 x 30 minutes, and have a special mechanism (SM) to ensure satisfactory operation in car radios, where a certain amount of vibration is often encountered.

To avoid poor tape transport and possible tape damage or breakage, always keep tapes inside the car **in the proper boxes or holders**, which have devices to **lock the spools**.

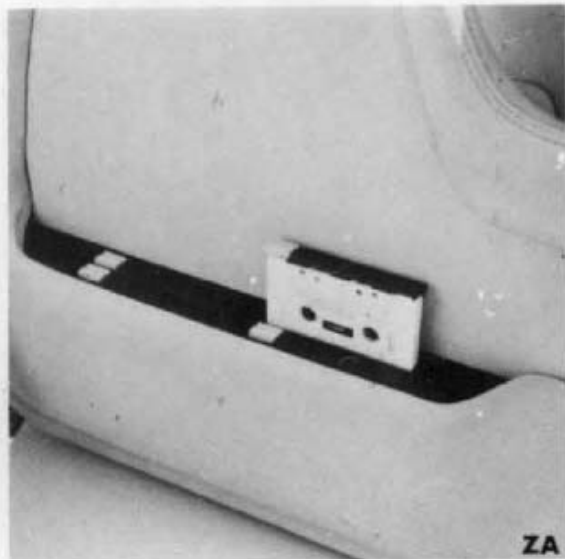

ZA

When a BMW cassette radio is ordered, a suitable cassette holder is supplied. Your cassette storage facility is provided in the right front door.

At extremely high or outside temperatures, for example below  $-10^{\circ}\text{C}$  or above  $+40^{\circ}\text{C}$  do not leave cassettes in a parked car, or they may distort and fail to operate reliably when next played.

In addition, protect all cassettes against direct sunlight and dust.

If the cassette is ejected during play, this is normally a sign that the tape transport is not running smoothly and freely. Do not merely push the cassette back in, but remove it and investigate the cause of the trouble.

If a loop of tape has formed, it can be taken up by turning one of the spools with a suitable object such as a ballpen.

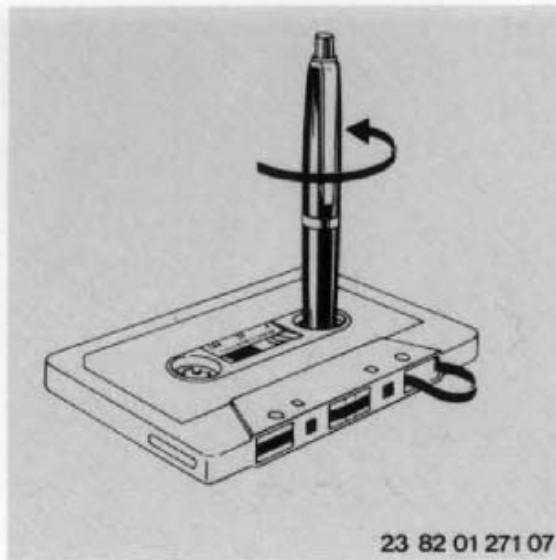

23 82 01 271 07

If a cassette cannot be played right through without this form of interruption occurring, insert it into the slot and immediately wind it completely through from one end to the other, so that the tape is wound on to the spool uniformly and at the correct tension.

The replay quality of cassettes deteriorates in the course of time as a result of unavoidable deposits of dirt and dust. The replay head inside the cassette player should therefore be cleaned at intervals of about 100 hours of operation.

For **replay head cleaning**, remove the cassette from the slot, hold the flap over the slot open by hand and remove dirt from the replay head with a tape head cleaning stick. Never use a sharp tool or hard object.

After about 1000 hours of operation, the cassette player should be examined by a qualified radio mechanic and overhauled if necessary.

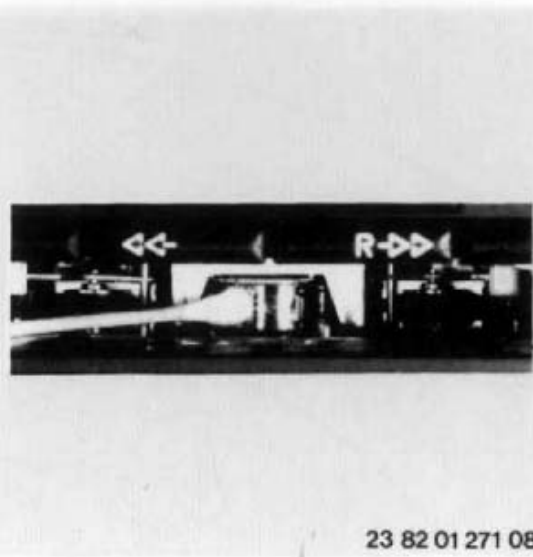

23 82 01 271 08

## Warranty terms

The warranty does not cover defects caused by careless or incorrect handling or installation, failure to install interference suppression on the vehicle as specified, the build-up of electrostatic charges or mechanical damage.

### WARNING:

Do not open up or tamper with the radio or cassette player, or else the warranty will become invalid and claims cannot then be considered.

## Exchange under warranty

During the warranty period a defective Bavaria radio or cassette player will be exchanged free of charge upon surrender of the complete exchange check to the BMW authorized dealer.

The warranty period is 12 months from the date of sale.



## Running-in – but how?

The engine of your BMW has not been governed in any way, so that there is no artificial restriction on its performance even when new. It is therefore up to you to ensure that the full operating life and potential economy are later achieved, and this is best done by adhering closely to the following **running-in rules**.

For the first 2000 km, drive at varying engine and road speeds, but do not exceed two-thirds of the permitted road speed in each gear. Do not use full throttle or the kickdown position of the accelerator pedal at all during this period.

Engine-speed/road-speed diagrams are to be found in **Section 6**.

Remember that the running-in rules apply to other mechanical assemblies such as the gearbox or rear axle, and not just to the engine.

Should any such assembly be replaced at a later stage in the car's life the running-in procedure must be repeated.

### **Hints on running-in brake pads:**

As a means of achieving uniform wear patterns and a good friction coefficient on new pads, avoid repeated violent brake applications, especially from high speeds, during the first 500 km and also prolonged severe loads such as may occur when

descending lengthy mountain passes. During the running-in period, refrain from subjecting the brakes to any form of endurance testing.

Brake pads, discs and drums require the distance stated above and the quoted operating conditions in order to bed down properly and give smooth results and freedom from premature wear later in the car's life.

Since the handbrake operates on an entirely separate brake system with its own drums, it must also be bedded in correctly.

If road surface, weather and traffic conditions permit, it is possible to achieve the desired effect by applying the handbrake lightly at about 40 km/h until definite resistance is felt. The lever should then be pulled up to the next notch and the car driven for about another 400 m before the handbrake is completely released.

This procedure will enable the handbrake to operate at maximum efficiency.

During the pre-delivery check, Inspection or Safety Test, your BMW service station will bed in the handbrake linings correctly.

You can repeat the process yourself, provided that due care is exercised, at three-monthly intervals or whenever handbrake action becomes less effective.

### **Running-in procedure for tyres:**

The production methods used in the tyre industry result in brand-new tyres having less than their designed adhesion at the road surface. For this reason, you are recommended to drive with restraint for the first 300 km.

During the **running-in period**, a degree of **stiffness** may be noticed at the gear shift, in the steering and other controls and mechanical assemblies. This will disappear after a short period of use and should be regarded as part of the normal running-in process.

**After 2000 km** have been covered, you can **gradually increase** your road speeds to the **specified cruising and top speeds** of your car, assuming that general road and traffic conditions make such speeds possible.

For proper operation of the engine it should be supplied with the following grade of fuel as available from reputable commercial sources, and without any upper cylinder or other additives:

**Super (premium) petrol (gasoline), to German Industrial Standard DIN 51 600 minimum octane number 98 (Research Test Method) or 88 (Motor Method) at sea level.**

In certain foreign countries care must be taken to ensure that only fuel of the necessary quality is purchased.

# BMW Safety: the contribution you can make **3**



- Driver's seat
- Seat belts
- Child restraint systems
- Check-Control
- Tell-tale and warning lights
- Antilock braking system (ABS)
- Heated rear window
- Wiper blades
- Fog lights
- Tyres
- BMW safety test
- Brake fluid
- Technical modifications

23 77 01 300 00

## Think of yourself – and others!

For your personal safety and that of the other occupants of the car, please note the following precautions:

Before starting a journey, all **windows** and **outside mirrors** should be clean so that visibility in all directions is unimpaired. Make sure too that **headlight and other lenses** are clean, so that you can see and be seen.

Having obtained the correct driving position, adjust the **inside and door mirrors** accordingly.

The **sun visors** can be swung down to prevent the driver or front passenger from glare in bright sunlight.

Adjust the **driver's seat** and if necessary its height and inclination, so that you can reach all the pedals without stretching your legs too much. Adjust the **seat back angle**, and the steering column if need be, so that you can grip the upper rim of the steering wheel with the arms outstretched but without having to lean forwards. In this position you should be able to hold the two sides of the steering wheel with arms slightly bent.

Back muscles and discs obtain most relief when you move **right back** with the seat in this position, and relax. This guarantees effortless driving and easy reach of the controls.

On long journeys, when not all the controls need continual operation, the seat back angle can be slightly increased, thereby further reducing the strain on the body muscles. Ideally, the driver's head should be on a line forming an extension to his spinal column.

**Warning: do not adjust the seat or steering wheel position when the car is moving – this may cause an accident.**

**Headrests** can only offer proper protection if positioned behind the head, not behind the neck.



### General remarks on seat belts

**Use the seat belts at all times, including in town traffic.** Only then can you obtain full benefit from the safety measures in your BMW.

The design of the belts makes them easy to put on and wear.

Cars leave the factory with the upper loop through which the seat belt runs attached to the highest anchorage point. To suit smaller drivers and front passengers, the BMW service station can reposition this upper anchorage 50 mm lower.



Place the straps free of twist across the pelvis (not across the stomach) and over shoulder and chest. Make sure that the tongue clicks in the lock.

To be effective, the belt must fit tightly on the body. It should be just possible to insert the flat hand between belt and body.

**While on the move the lap strap should be tightened quite often by pulling the shoulder strap,** to take up any slack due to clothing or changes in seating position.



To release the belts, press the red button in the lock and guide the buckle back towards the door so that the retractor can roll the belt up.

Operation of the automatic belts is checked by the BMW service station during inspections as follows:

1. By pulling the belt rapidly out with the car standing still.
2. By applying the brakes with the upper part of body pressing against the belt.

In both cases the retractor must lock.

Have the locks, retractors, fittings and straps checked for damage and operation by your BMW Service station from time to time.

Do not tamper with any restraint system – for your safety and that of your passengers.

Only secure one person (over 6 years or as permitted by law) with each belt. Do not allow the belt strap to rub against sharp edges, or the protective effect of the belt may be lost.

If the belts or the BMW child restraint system are stressed in an accident they must, for safety reasons, be replaced.

Care of the belts is described in **Section 5**.



### **BMW child restraint systems**

**Children should always be carried on the rear seat. This may be a legal requirement.**

Standing up between the two front back-rests is particularly dangerous. For your child's safety, have the BMW child restraint system installed. In the development of this system we have paid close attention to comfort so that after a short time the child will be willing to follow your example and use a belt.

Detailed fitting instructions are included with each BMW restraint system and the anchor points are provided on the vehicle (bolt attachment points or holes in the floor pan and rear window shelf). Your BMW service station will also install these items for you if you wish.

To provide adequate room for forward movement should the special stitching yield in an accident, the seat in front of the child should be pushed forward at least to a central position.

### **BMW child's seat**

The BMW child's seat is designed for children from sitting age (about 9 months) to a weight of 18 kg [about 5 years].

To install seat, first push the hoop on the seat between the rear seat base and back. Hook the side straps to the eyes on the set and the upper hooks to the end fitting on the parcel shelf. The free ends should be tightened so that the seat is fixed firmly in position.

When the child uses the seat for the first time, the length of the belts must be adjusted. First adjust the lap part by sliding the straps through the adjuster and then tightening across the pelvis (not the stomach). Fit shoulder part like braces and tighten in the same way. It must be just possible to insert the hand flat between the child's body and the belt.

The seat can be moved to the sleeping position by slightly slackening the side straps, pulling out the locking pin and swinging down the large handle.

After releasing the hooks by pressing the spring with the thumb, the BMW child's seat can be taken out of the car and stowed in the luggage compartment. The mounting straps remain in position in the car.





### BMW 'Junior' child restraint system

The BMW child's belt is designed for children weighing from 15 kg [about 4 years] to 36 kg [about 12 years]

**The seat shell** can be used up to the age of about 8 years. It gives not only optimum seating comfort and lets the child see what is going on around it, but also improves the lap belt run as recommended by medical experts.



12 78 01 310 00

To install the seat shell, open the side locks, insert the shell, pass the lock tongues through the slots in the shell and engage in the lock. If necessary, tighten the lower part by pulling the free end so that the seat is fixed firmly in position.

To put child in seat, open centre lock, place child on seat and pass shoulder straps over shoulders free of twist. Then close the lap belt and remove slack by pulling the loop on the upper fitting so that the belt joint is about 10 cm behind the child's neck. To lengthen the belt, swing the adjuster through 90° and pull the shoulder straps out symmetrically.

One further important point: although BMW restraint systems are very comfortable to use, you should give the children and yourself a break after driving for not more than 2 hours. Before leaving the car in bright sunshine, cover up all parts of the belt or seat which contact the child, using a blanket or something similar, to prevent them from getting too hot.

### Treatment of child after an accident:

If the child is unconscious after an accident, or complains of a headache or neckpains, it must be lifted carefully out of the car, supporting the head all the time. Lay the child down gently on a suitable underlay and cover it with a rug to keep it warm. **Summon a doctor without delay.**

The **Active Check-Control** enables you to confirm the correct function of the systems it monitors before and during a journey. See **Section 2**.

Any malfunctions detected by the Check-Control are displayed each time the engine is started, and stored in the system's memory. Have these faults rectified without delay in the interests of reliability and safety. See **Section 5**.

Be very careful when **starting the engine inside a garage** or other enclosed space: do not inhale the exhaust gas, which contains odorless, invisible and highly toxic carbon monoxide gas. Always open a door before starting the engine.

After the engine has been started, the **battery charge, oil pressure and brake pad wear warning lights** will go out.

If they remain on, or go out but come on again during the journey, refer to the instructions in **Section 5**.

The **brake warning light** also goes out after the engine has been started. If it remains on, this indicates loss of brake fluid from the reservoir. If the light comes on suddenly during a journey, refer to **Section 5**.

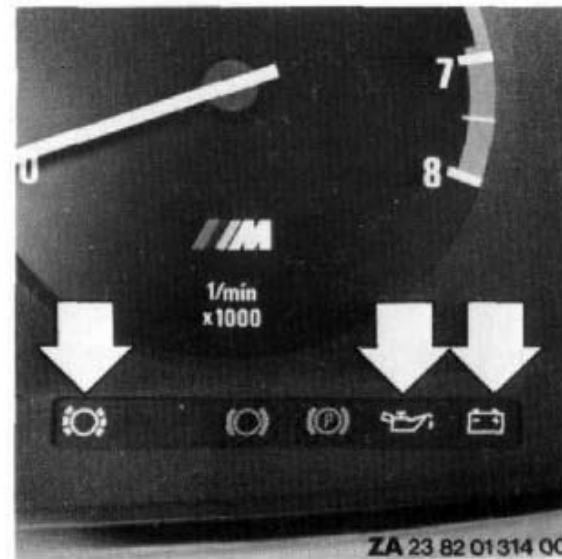

### Antilock braking system (ABS)

To further increase active road safety, your BMW is equipped with an antilock braking system.

The yellow **ABS telltale lamp** goes out after the engine has been started. If a fault develops in the ABS, the lamp will come on during the journey. The antilock system is then out of action but the normal braking system remains fully operational.



The **electric heating elements on the rear window** ensure unrestricted vision to the rear and prevent or remove fogging or ice build-up in freezing conditons.

When cleaning the inside of the rear window, avoid aggressive or abrasive substances or solvents which might damage the electro deposited heating elements.

Do not obstruct rearward vision with large objects placed on the parcels shelf beneath the rear window, and remember that these could fly forwards during a collision and cause injury.

Do not neglect the **wiper blades** either. If they leave streaks or unwiped areas, they may affect your view of the road. Wiper blades should be renewed at least twice a year.

The **rear fog lights** on your BMW are intended to make the car more easily visible to following road users in thick fog, and to show up at a greater distance.

**Fog lights** greatly improve illumination close to the car in thick fog, and like the rear fog light are valuable active safety features. Remember that there are national regulations covering the positioning and use of fog lights.

The **radial-ply tyres** approved by the factory for your BMW have been carefully selected for optimum road safety and the desired high level of ride comfort.

The condition of the tyres and **maintenance of the correct tyre pressures** will not only affect **tyre life** but also play a great part in assuring **safe driving** under all conditions.

Full information on tyres will be found in **Section 4**.

In addition to regular inspections, it is good practice to have the **BMW Safety Test** performed as well on the occasion of the Oil Service. This ensures your car's road safety and is in the interests of your personal protection and that of all occupants of the car.

#### **Warning: transistorised coil ignition and digital motor electronics**

This is a high-output ignition system, and it is **highly dangerous** to touch any live components when the engine is running.

**Brake fluid** is hygroscopic by nature, that is to say it will tend to absorb moisture from the atmosphere over a period. In order to ensure that the brake system remains fully operational, **the brake fluid must be renewed once a year** by your BMW dealer.

**The reservoir should be filled to the upper "MAX" mark.**

Your BMW dealer knows the factory approved grades of brake fluid.

Before undertaking any **technical modifications** to your car, please consult a BMW service station, quoting the chassis number, concerning the practical value, legal position and factory attitude to such modifications.



# BMW driving methods and how to keep running costs low

4



- Fuel consumption
- Economy
- Checking oil levels
- Checking coolant
- Battery
- Disc brakes
- Tyres
- Wheel-changing
- Winter operation
- Foreign travel
- Towing a trailer

23 83 400 00



## On your way!

For trouble-free operation of the engine in your BMW, always use the following grade of brand-name fuel, not containing any upper-cylinder or other additives:

**Super (premium) grade petrol (gasoline), to German Industrial Standard DIN 51 600 minimum octane number 98 (Research Test Method) or 88 (Motor Method) at sea level.**

In certain foreign countries, you should make sure that only fuel of the correct minimum quality is purchased.

If you have no choice but to refuel with a grade having a lower octane number and thus less anti-knock resistance, observance of the following rules will help to eliminate 'pinking' or pre-ignition to a large extent.

Keep the engine turning over at speeds between 2500 and max. 4000/min at all times, shift down to a lower gear in good time and accelerate gently and smoothly. **Section 6** contains graphs of road speed and engine speed.

It is unnecessary to warm the engine up at idle speed; instead, drive the car away immediately after it has been started, using **moderate** engine speeds only. If outside

temperatures are exceptionally low, however, allow the engine to run for about half a minute at a fast idling speed in order to ensure that oil reaches all parts of the engine. Never run a cold engine at a high speed, as this will cause rapid wear and shorten its useful operating life.

If driving under load and accelerating or climbing hills, try to prevent the engine speed dropping below 1500/min. Shift down to a lower gear in good time, particularly when tackling gradients.

When declutching, press the clutch pedal down fully; during normal driving, do not rest your foot on the clutch pedal.

On automatic transmission cars, the brake pedal and accelerator should both be operated **with the right foot only**.

After a lengthy period spent in heavy city traffic or in a slow-moving queue of vehicles, you are recommended to give your car's engine a chance to 'breathe deeply' by driving for some distance at engine speeds above 3000/min. This will disperse any soot deposits in the combustion chambers.

The standard test method used for determining **fuel consumption** is that laid

down by German Industrial Standard DIN 70 030, Part. 1. It is by no means identical with the car's average fuel consumption in everyday driving, which depends on a variety of factors such as driving style, load, road conditions, traffic density and flow, weather, tyre pressures, etc.

**Section 6** of this handbook includes graphs of **fuel consumption** at various steady speeds, with the car in standard trim and two persons on board.

The **economy** of your BMW depends to a large extent on your driving style.

Driving economically means watching the traffic well ahead and adapting to the conditions. Driving economically does not only mean driving slowly. High speeds, accelerating in the gears up to the maximum speed, hard cornering and braking all cause higher fuel and oil consumption and increase the wear on tyres, brakes and all parts of the power unit.

Refer to the following pages for suggestions and explanations on economical driving. They will repay closer study.

## The 'Ten Commandments' for energy-conscious driving

### **1. Do not warm up the engine to operating temperature at idle speed, and never leave the engine to idle for long periods.**

Driving your car away immediately after starting is the quickest way of warming up the cold engine to its normal operating temperature. And the right operating temperature means greater fuel economy. Switch off the engine when you stop for a prolonged period. Only three minutes at idle speed cost as much as 1 km on the open road.

### **2. Do not drive up to maximum speed in 1st gear – use it only for starting off.**

First gear consumes more fuel than any other gear at a given road speed. Full-throttle getaways result in unnecessarily high fuel consumption.

### **3. Shift up to a higher gear in good time, and try to drive in the higher and more economical 3rd, 4th or 5th gears.**

Example: Driving at a steady 50 km/h in 2nd instead of 4th gear consumes up to 100% more fuel.

It can still be as much as 30% more if you use 3rd gear instead of 4th at the same speed. BMW engines have such excellent torque that they can be driven without hesitation at low speeds in high gears.

Incidentally, lower engine speeds not only reduce fuel consumption but also cut the amount of noise emitted by the engine – often a source of annoyance to residents, particularly in otherwise quiet areas.

Try to drive the car quietly whenever possible. Reducing the noise burden for fellow citizens brings its own reward – lower fuel costs for you BMW.

### **4. Adopt a moderate driving style and avoid extremes.**

Do not accelerate when you can see that you will have to brake in the next few moments. Drive quickly but smoothly and steadily. Try to keep off the brakes, allow your car to coast and avoid traffic jams whenever possible.

### **5. Avoid driving at full throttle for long periods.**

The maximum power potential of a car is one of its most important safety reserves. However, if you always use maximum power on busy main roads, you will be constantly braking from maximum speeds. That costs energy. Steady average speeds help save fuel, nerves and wear and cost only very little extra time.

### **6. Check tyre pressures regularly.**

If the tyre inflation pressure is less than specified, rolling resistance is increased, and your fuel consumption too.

### **7. Do not carry unnecessary weight (ballast) or use a roof rack.**

Every bit of extra weight wastes energy. Do not carry your 'weekend luggage' with you all the time. A roof rack increases air resistance and fuel consumption. Remove roof or ski racks immediately after use.

### **8. Plan your journeys in advance if possible.**

Every traffic jam and every unnecessary, tiresome search for a parking space costs energy. You should plan to avoid rush-hour traffic and times when there is a lack of parking spaces in city centres. You can often miss traffic jams by starting your journey half an hour earlier or later.

### **9. Have your car serviced regularly and the necessary adjustments for maximum fuel economy performed.**

An ideal fuel-air mixture and optimum utilization of fuel depend on the condition of the air cleaner, spark plugs, valves, fuel supply system and the ignition system. Regular servicing can produce a fuel saving of up to 10%. That means that the average car user would need some 150 litres less fuel over the year if his car were always set up and adjusted correctly.

### **10. Check your car's fuel consumption regularly and accurately.**

Only if you know your own car's fuel consumption can you compare it with the car maker's specifications and empirical values. And it is only possible to keep a check on your method of driving and have minor engine adjustments performed in good time if you record the fuel consumption.

And here are a few additional and useful tips:

**“Commandments” 1-5:  
More skilful driving pays off where it is needed most: under difficult conditions.**

Let us start at a common point: A medium-size BMW car consumes about 7 litres/100 km at a steady 60 km/h. But in town traffic we average only 20 km/h and usually consume twice as much in the process. It is in this area therefore that we can adopt new ways of behaving and observe some relatively simple driving rules. The simplest basic rule here is always to drive in the highest possible gear or, put another way, use the lowest engine speed at all times. You will have to change gear a little more often, but the fuel saving is considerable.

As you drive, be conscious of the next gear shift or braking decision. Do not accelerate when you can see that you will have to brake a few moments later. Cars which move forwards in a series of jerks not only hinder the smooth flow of traffic, they are constantly wasting energy.

**Sensible use of engineering excellence**  
One very good psychological precondition for staying cool and composed at the wheel is a car which makes it just as easy to accelerate as to give way. Cars which make one drive considerably because they offer safety reserves that enable them to be manoeuvred with agility and speed in traffic whenever the need arises, and help their driver in many situations in which one suddenly requires the power and safety potential of a BMW. As we said, when you have the power to accelerate, it costs only a smile to hold back and give way.

### The instruments show you the way to economy

The graph shows the fuel consumption in relation to road speed in the individual gears. It is clear how important it is to change gear in good time. BMW drivers have the advantage of possessing an engine which develops high torque over a wide rev range and thus allows up-shifts to be made very early without sacrificing either safety or comfort.

Low consumption is encouraged if you shift to a higher gear at the earliest practical moment when accelerating.

Refer to **Section 6** for graphs of engine speed and road speed.

The recommended engine speeds stated below enable you to read off the most suitable road speeds (other factors permitting) for low consumption, depending on which manual gearbox you have specified for your BMW.

Engine speeds can be kept low without loss of performance, since 85% of maximum engine torque is available at only

3500 R/min on the BMW 745i

At approximately these engine speeds the engine will use a minimum amount of fuel; try to use the gear shift to keep within this speed range most of the time.

**A recommendation:** note the speedometer readings corresponding to maximum engine torque and the equivalent road speeds in intermediate gear ratios.

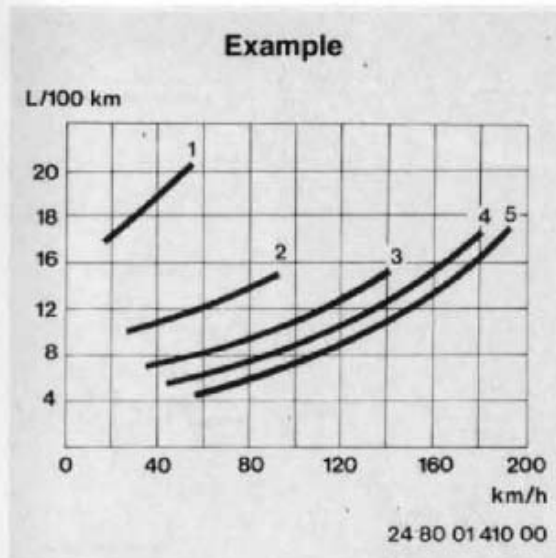



**Thoughtfulness reduces the burden on you and your tank**

The graph below illustrates how different fuel consumptions can be achieved at the same average speed when different driving styles are employed.

The graph plots the driving methods of two drivers: Driver A (solid line) driver B (broken line).

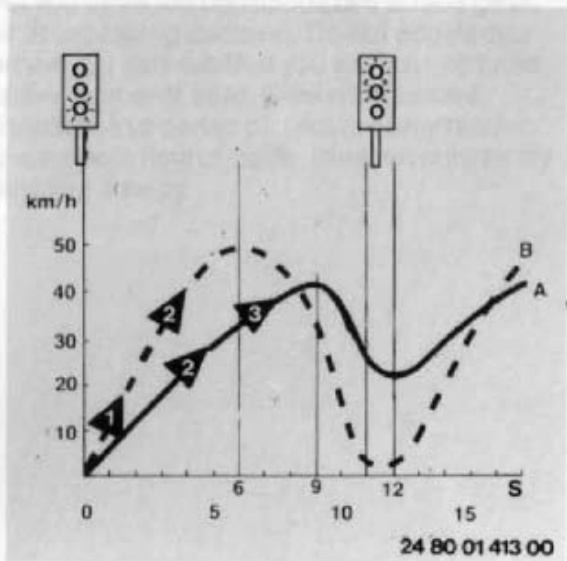

Driver B accelerates fully in 1st and 2nd gears between the first and second set of traffic lights and arrives at the lights earlier than driver A, but must brake hard because the traffic lights are red. Driver A on the other hand does not use full throttle through the gears and shifts up to 3rd gear. He sees that the lights are at red, reduces his speed and can then drive across the junction in 2nd gear without braking because the lights change to green as he arrives.

**A high average is better than high speed**

When one looks at the speed diagram of a car that has been driven at the maximum speed at every opportunity on a busy main road, one notices the following:

The extreme fluctuations clearly demonstrate that it can be far better to travel at a steady high average speed which matches the general flow of traffic. That saves a lot of nerves and a lot of energy as well. Every time the car is braked heavily the brake discs unnecessarily convert valuable energy into heat.

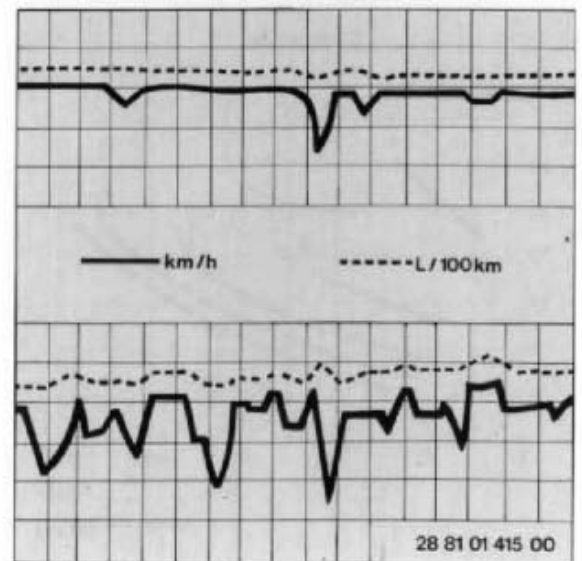



### “Commandment” 6:

Driving with the tyres under-inflated reduces their useful life and increases the risk of tyre damage; the tyre is flexed and deformed excessively and thus becomes too hot. Its rolling resistance is also increased, more engine power is required and fuel consumption is accordingly higher. Check tyre pressures regularly, at not more than 14-day intervals.



### “Commandment” 7:

#### Energy – disappearing into thin air?

The graph below shows the power which must be expended to overcome air resistance as vehicle speed rises. A segment is shown (see shaded area) because car shapes vary and therefore have a lower or higher air resistance to overcome.

A = Higher air resistance  
B = Lower air resistance

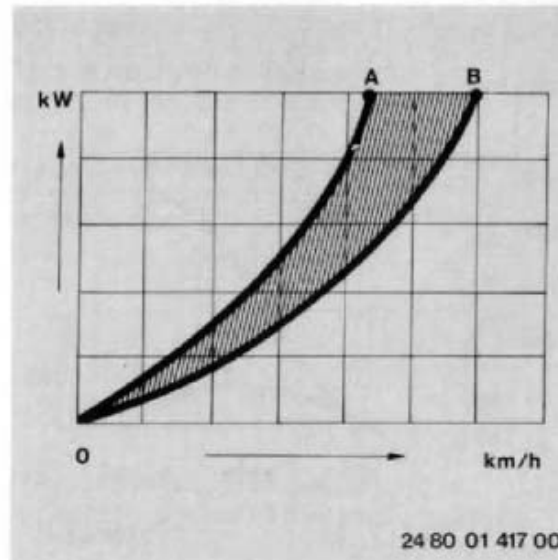

### “Commandment” 9:

#### A united effort to reach a common target: may we ask for your undivided attention?

The automobile industry, in Europe in particular, has progressively reduced fuel consumption over the past decades while satisfying greatly increased customer requirements. It's extraordinarily intensive investment and research programs are directed at improving the results obtained up to now while maintaining or even surpassing present safety and comfort requirements. But that in itself is not enough. As we have to save energy now with the existing car population and existing technology, we ask all car users to make their contribution – in addition to the efforts of the government and the industry.

**BMW engine technology makes it easy for you to adopt a reasonable approach**

The best prerequisite for a new economical way of driving is the ultimate in engines – as offered by BMW. A power unit that delivers high torque at the lowest possible engine speeds.

In this respect a BMW offers you maximum efficiency. The special characteristic of all BMW cars is their ability to accelerate smoothly at high revs as well as giving you

plenty of jerk-free bottom end power.

**A BMW responds with smooth power delivery when others are still hesitating**

An example: The torque curve shows why a BMW engine is the ideal prerequisite for fuel-efficient motoring at low engine speeds. The BMW delivers 85% of its maximum torque, i.e. its maximum pulling power, at between 1600 and 2400 rev/min. It can be driven smoothly, comfortably and safely in high gears, i.e. the economic 3rd, 4th and

5th gears, at low speeds on city roads.

It does not hesitate, will accelerate quickly when required and, because the engine is not under load, consumes very little fuel even when compared with smaller cars.

The engine is supplied with dust-free combustion air by way of the air cleaner. If the air cleaner is very dirty, the engine will be starved of fresh, clean air and the result will be an increase in fuel consumption and a reduction in performance.

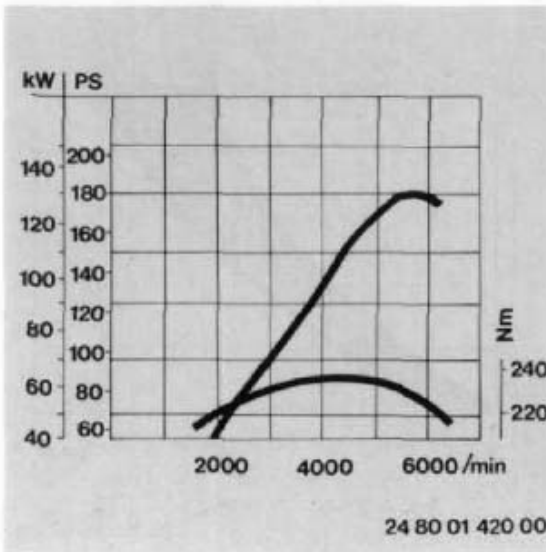

Sooted and worn spark plugs reduce engine power and waste fuel. Checking them regularly also contributes to economic use of energy.

A fuel supply system service, i.e. checking the setting, can suddenly make one realise what economy is about. Your BMW dealer performs the fuel supply system service not only to provide you with optimum economy but also to ensure that the exhaust gases remain clean and protect the environment.



24 80 01 422 00

## “Commandment” 10:

### Having faith is good, checking is better

The secret of energy-conscious driving is knowing exactly what your car consumes. Only if you establish what the effects of different driving styles are on consumption and what readjustments can do for the engine will you act and react with greater awareness in future.

Keep a constant check on how much fuel you use.

### Preconditions for fuel consumption measurement

1. The engine must be run in.
2. Fill the tank to the brim.
3. The car should be perfectly level when you fill up.
4. Get rid of air pockets in the tank by rocking the car.

### “Observation” – measuring the consumption

After finishing your journey, fill the tank to the brim again.

### This is how you calculate your consumption per 100 km

$$\frac{\text{Fuel consumed in litres} \times 100}{\text{Distance covered in km}} = \text{Fuel consumption in litres per 100 km}$$

Please observe the specifications regarding grades of fuel and engine oil

**Engine oil consumption**, like fuel consumption, depends on the way in which the car is driven and the operating conditions.

**We recommend that you check engine oil level regularly**, for instance whenever you buy fuel. If necessary, add fresh oil of the same grade as that already in the engine to the filler on the engines rocker cover. Do not fill beyond the upper mark on the dipstick.

The most accurate oil level reading will be obtained with the car standing on a level surface and the oil cold (before the engine is started), or after allowing the oil to drain back

into sump for a short period (if the engine has already been run. Make sure that the loop handle of the dipstick points towards the front of the car and that the dipstick is inserted fully into the tube on the engine block.

**The quantity of oil represented by the space between the two marks on the dipstick is app. 1,0 litre.** Adding too much oil serves no useful purpose and may even harm the engine. Since this excess oil will tend to be burned off within a short time, it may create the impression oil consumption is heavier than usual.

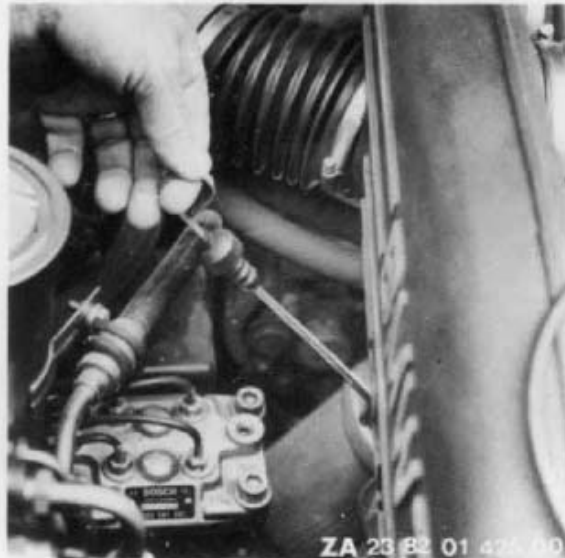

The best procedure is to add fresh oil only when the level has dropped almost to the lower mark on the dipstick. However do not allow the level to fall below the minimum-level mark.

**Avoid a change to a different grade or make of oil unless the oil is drained completely from the engine and the oil filter element also renewed.**

Our engines are designed to require **no oil additives** if one of today's highly advanced brand-name lubricating oils is used: indeed, using additives could cause damage. The same applies to the oils for the manual gearbox or automatic transmission, final drive and power steering.

#### **Engine oil specification**

Use only brand-name HD engine oil for API-SF/CC or API-SF/CD spark-ignition engines, to specifications. Any special low-friction oils are not approved by BMW.

The SAE grade (viscosity) depends on the outside air temperature range and therefore on the season of the year.

The chart on the following page indicates the correct SAE grade of engine oil for differing prevailing air temperatures.

Note that the temperature limits for the various SAE grades may be departed from, but only for **brief periods**.

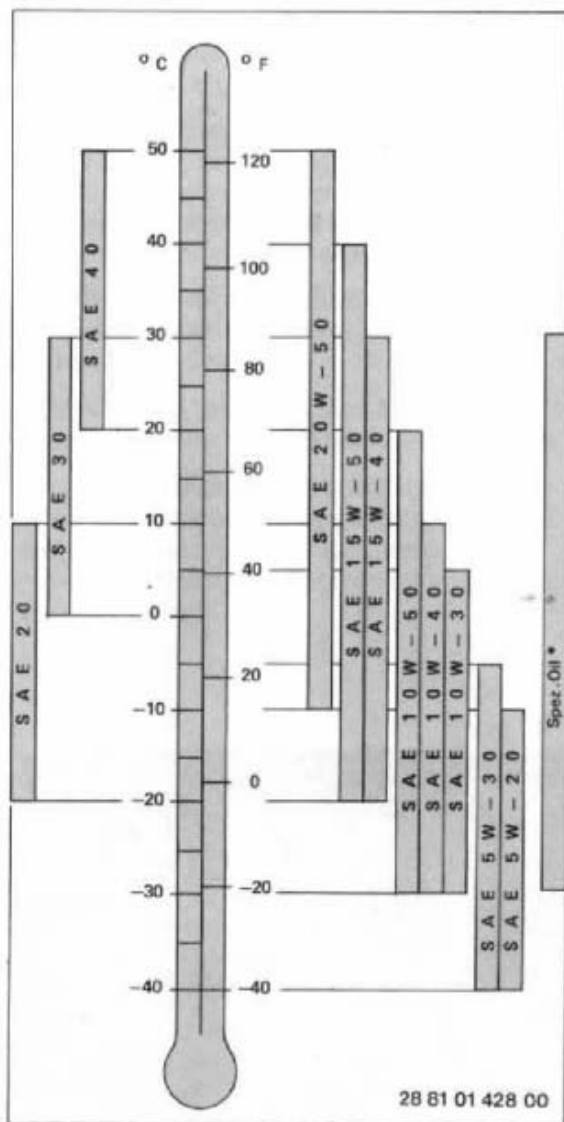

\* Special oils individually approved by BMW (low-friction lubricants)

**Check oil (ATF) level in the automatic transmission** regularly, e.g. when engine oil level is checked.

The car should be standing on a flat, level surface, with the handbrake applied. The engine should be at **normal operating temperature**. Select P or N at the transmission selector lever, and allow the engine to idle.

Pull out the transmission dipstick, wipe with a **non-fluffy** cloth and push back in to measure the oil level. It should be between the two dipstick marks.

**The quantity of oil represented by the distance between the two dipstick marks** when the transmission is at normal operating temperature is app. 0,4 liter.

**Oil grades:** see Section 6.

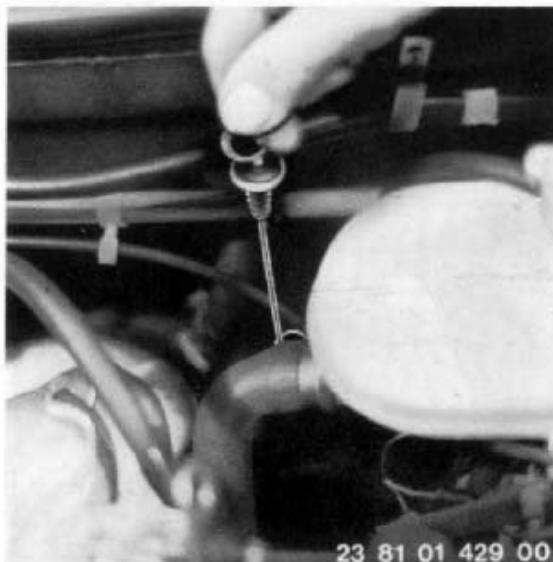



**Check oil level for the power steering and brake hydraulics.**

**With the engine stopped**, remove the wing nut and take off the fluid reservoir cover. Apply the foot brake several times until the oil level ceases to rise or the pedal becomes noticeably more difficult to press down; about 10 brake applications will be necessary. The oil level must rise to app. 10 mm below the upper rim of the reservoir. Correct if necessary by adding more oil (not brake fluid!) of the correct grade (see **Section 6**).

Attach the cover to the reservoir and tighten the wing nut. Make sure that the cover is correctly seated, and inspect the remainder of the steering system for leaks.



The transparent **fluid reservoir for the brake and clutch operating circuits** is in the engine compartment, at the right, and permits the fluid level to be checked without removing the cap.

If the fluid level should drop, an electrical sensor in the reservoir will illuminate the red **"Brake" warning light** in the instrument cluster.



Brake fluid is hygroscopic, that is to say it gradually absorbs moisture from the atmosphere. To ensure that the brakes on your car remain fully operational, the **brake fluid must be renewed once a year** by a BMW service station.

**Brake fluid level in reservoir:** up to the "MAX" mark.

Your BMW service station is familiar with the factory-approved grades of brake fluid.



The **transparent coolant header tank** permits coolant level to be checked without removing the cap.

**Open the radiator or header tank cap** only when the engine has cooled down and the coolant thermometer needle is on the lower third of the scale, or else hot water or steam may escape and cause **scalding**.

Turn the cap slightly counterclockwise to allow excess pressure to escape, then remove completely.

Add water up to the mark on the header tank, and screw the cap back on clockwise.

Overfilling will dilute the additives in the coolant, which will escape through the overflow pipe and no longer possess the correct antifreeze and corrosion inhibitor concentration.

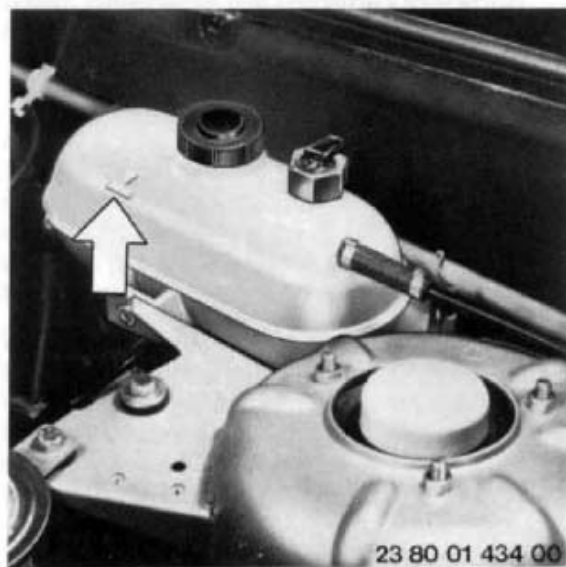

Use only factory-approved long-term antifreeze and corrosion-inhibiting products. Your BMW service station can recommend and supply them.

Renew the coolant completely **every 2 years**.

The windshield washer can be kept fully operational by adding antifreeze according to DIN 51421 standard or equivalent, in the proportions recommended by the manufacturer.

Check operation of that system at regular intervals.

**Intensive cleaner** is available in litre bottles from your BMW dealer, ready to use in the additional tank.

#### **Note well**

The reservoir fitted to the left of the coolant header tank, serves as a breather for vehicles fitted with manual type transmissions, **lubricant, oils and water** must not, under any circumstance, be added to this reservoir.

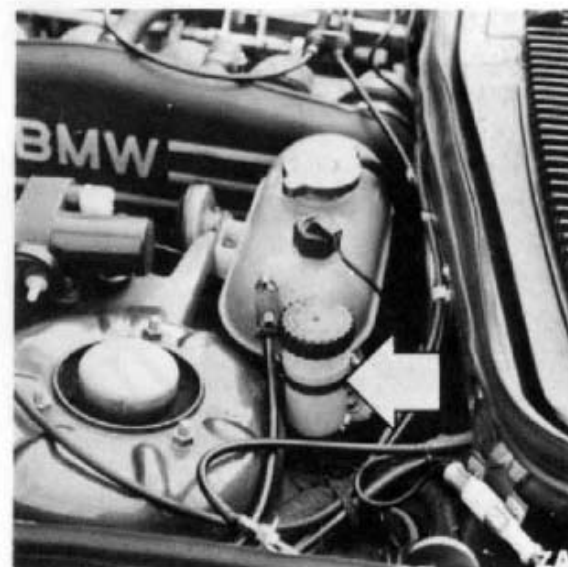

## Battery

The battery of your BMW is maintenance-free.

Keep the upper part of the battery dry and clean.



ZA 23 77 01 437 00

## Important notes:

1. Particles containing acid or lead oxide must never be allowed to contact the eyes, skin or clothing. Rinse off immediately with clean water, and consult a physician if injury has occurred.
2. Never short-circuit the battery poles; the resulting violent spark could cause severe electric shock or burns.
3. Never detach the battery leads when the engine is running, or else an over-voltage will occur and damage the car's electronic equipment beyond repair.
4. To recharge the battery without removing it from the car, the engine must be stopped and both battery leads disconnected.
5. Disconnect the negative lead from the battery before attempting any work on the car's electrical system, to avoid the risk of a short-circuit.
6. If the vehicle is to be laid up out of use for a fairly long period – see **Section 5** – remove the battery, have it charged and store in a cool place with no risk of frost damage. The battery must be recharged after not more than 6 months, or it will be damaged and cannot then be re-used on the vehicle.
7. To remove the battery, first disconnect the negative lead, then the positive lead. Unscrew the battery retaining bar. When installing, first secure the battery with the retaining bar, then connect the positive lead and finally the negative lead.



ZA 23 77 01 438 00

### Useful information on disc brakes

The **brake booster servo** on your BMW operates hydraulically, so that the necessary pressure is built up only when the engine is running. When the car is moved with the engine stopped, for instance when being towed, a much higher pedal pressure than usual will be needed to produce the anticipated braking effect.

On long downhill gradients the engine's braking action when the throttle is closed can be increased by selecting a lower gear. Never run downhill with the clutch pedal depressed, the gear lever in neutral or – a very dangerous practice – the ignition switched off.

It is essential to observe the running-in instructions for the braking system when new brake pads are fitted – see **Section 2**.

**Warning: When renewing brake pads, only approved brake pads should be used, otherwise the General Operating Permit or equivalent may be invalidated.**

A disc brake system offers optimum braking efficiency, smooth response and a high load capacity. The high temperatures which occur during brake applications, e.g. on mountain passes when driving quickly, necessitate a maximum degree of cooling which is provided exclusively by ram air or the peripheral speed of the brake discs.

Wet conditions, dirt, salt spread on winter roads, and corrosion of the brake discs can impair brake behaviour by increasing braking distances, altering the car's normal brake pressure distribution, or causing variations in the coefficient of friction on the individual wheels, and thus make the car pull to one side.

Corrosion of the brake discs is accelerated if the car is used very little or garaged for long periods.

Gentle or moderate use of the brakes also promotes corrosion of the brake discs and allows the brake pads to become dirty because the minimum pressure necessary for the disc brake's self-cleaning action is not reached between the pad and disc.

Corroded brake discs cause a knocking effect when the brakes are applied and this cannot generally be eliminated by prolonged braking.

On the other hand, slight corrosion and surface roughness can be removed by means of brake pads with an abrasive corundum coating. Your BMW dealer will gladly provide information on braking during the running-in period, use of these brake pads, etc.

Dirt burnt into the brake pads (glazing of rubbed area) and clogged drain grooves cause scoring of the brake discs as well as a change, reduction or delay in braking effect.

Another problem in this connection is brake squeal, which tends to increase in intensity as the discs become dirtier or glazed.

All these **climatic and environmental effects cause a change in the brakes' coefficient of friction**, i.e. less braking efficiency is available for a given pedal effort. If the coefficient of friction changes in this way the brakes may respond unevenly or pull to one side.



### **Keeping your disc brakes in trim**

Every now and then disc brakes should be applied quite hard once or twice from high speed – providing traffic conditions allow. The high brake pressure produced in the process ensures that the brake pads and discs are kept clean.

Similarly, on long journeys in poor weather conditions, especially in winter when salt has been spread on the roads, it is advisable to apply the brakes firmly from time to time. This not only tests their efficiency in the prevailing conditions (take care at temperatures around freezing point), but each 'test' application allows the self-cleaning action to take place and thus ensures the brakes' readiness for operation even under the worst weather conditions.

In wet conditions or during rainfall it is advisable to apply the brakes briefly with light pedal pressure every few kilometres. The heat generated in this way keeps the discs and pads dry for a certain period.

Before you park the car after driving through the rain, and especially if salt has been spread on the roads, lightly brake the car to standstill so that the brake discs remain dry and cannot corrode easily.

If the brake discs already show signs of corrosion it is possible to cure the problem in its early stages by applying the brakes hard several times. Take care not to endanger other road users and avoid locking the wheels!

The most effective braking action is achieved not with locked wheels, but when the wheels are still just turning. Locking the wheels can be dangerous, as locked front wheels can no longer be steered, and locked rear wheels cause the car to slide sideways or spin.

If brake disc corrosion is advanced and the brake pads are dirty (glazed brake area, blocked drain grooves), the discs and pads should be inspected, cleaned or repaired by a BMW service station.

**The brake system of your BMW should be checked regularly before and after winter by a BMW service station, possibly in conjunction with the prescribed inspection work.**

**Important: Always have the brake fluid changed every year.**

We recommend you to consult a BMW service station without delay in the event of any faults occurring in the brake system.



## What you should know about tyres

The factory-approved **radial ply tyres** have been chosen to suit your BMW and provide both optimum road safety and the desired level of ride comfort.

The condition of the tyres and maintenance of the **specified tyre pressures** are vital factors affecting **tyre life** and also **road safety** to a very high degree.

### Tyre pressures

Incorrect tyre pressure are a frequent cause of complaints concerning tyres. Furthermore, they may seriously affect the roadholding of your BMW.

**Check tyre pressure at regular intervals** and before starting fairly long journeys, but **at least every two weeks**. Do not forget to check the spare wheel as well: it should be kept at app. 0,3 bar above the specified pressure for a fully loaded vehicle.

The correct tyre pressures for your car is shown in **Section 1**.

If tyre pressures are lower than specified, this will adversely affect road safety by reducing lateral locating force. The increased degree of tyre sidewall flexing will lead to excessive heat buildup and thus introduce an element of risk into high-speed driving. Fuel consumption will be increased by the tyre's greater rolling resistance, and tread wear will be more rapid.

If tyre pressures are too high, ride comfort will suffer, the tyre may lack grip and tread wear will again be rapid and uneven.

The tyre valves are provided with **screw dust caps** to keep out dirt. If dirt enters the valve, a slow leak may result.

Tyres have to withstand very severe loads at high speeds, particularly in hot weather and at the maximum weight limit for your car. Remember to increase tyre pressures if loads are high, and not to exceed the **permissible axle loads**.

**For your own safety:  
check tyre pressures regularly!**

### Tyre treads – tyre damage

Check the condition of the tyres frequently: look for damage, stones and nails, premature wear and overall tread pattern depth.

**The tyre tread** is regarded as acceptable by law in many countries if only 1 mm deep, but it is advisable to renew tyres when the tread depth has worn to 3 mm. Below this depth, there is a serious risk of aquaplaning at even moderately high speeds and when the roads are apparently not too wet. If the tyres wear down to 1,6 mm tread depth, a wear indicator will become visible at the base of the tread pattern as a reminder that the legal limit of tyre wear is approaching.

Always match your road speed to the condition of your tyres – particularly the remaining tread depth – and to weather conditions.

**Tyre tread wear** on the front wheels tends for design reasons to be slightly more rapid on the outer shoulders of the tyre, whereas on the rear wheels it is concentrated more on the inner shoulders and the centre of the tread.

On the other hand, we recommend that front and rear wheel alignment be checked once a year and whenever new tyres are fitted. Any exceptional rates of tyre wear imply that wheel alignment is incorrect: this should be checked and put right by your BMW service station.

Tyres must never have their treads recut, in view of the risk of damaging the tyre carcass.

Any **foreign body** (nail or similar sharp object) penetrating the tyre may cause a slow puncture which will be recognised as the need to correct the tyre pressure more frequently. In this event the tyre should be checked and either repaired or renewed as soon as possible by your BMW service station or a specialised tyre workshop.

Drive at a moderate speed over poor road surfaces and approach unavoidable obstructions, such as a kerb or severe bump in the road, with care so that the **inner structure** of the tyre does not suffer damage invisible to the naked eye.

Take care not to bump the **tyre sidewalls** when parking or driving onto loading ramps, car lifts, etc.

Avoid overloading your BMW – especially on vacation trips. Overloading the vehicle can also exceed the tyre's permitted load capacity and thus cause **premature or subsequent damage**.

Tyre damage can be extremely dangerous for both yourself and other road users.

### Renewing tyres

Only tyres of the same type and construction must be fitted on all four wheels. A mixture of cross-ply and radial-ply tyres is not permitted because it greatly impairs the vehicle's behaviour.

Furthermore, in order to maintain the good ride and handling properties of your BMW all tyres should be of the same make and tread pattern.

BMW rejects the use of remolded or retreaded tyres owing to the possibility of differences in the tyre carcasses and their sometimes very advanced signs of ageing, which can have a detrimental effect on their durability and, under certain circumstances, the car's handling and safety.

**Before undertaking any change to the tyres on your car**, please consult a BMW service station concerning the practical value, legal position and factory recommendations. Quote the car's chassis number.

A knowledge of tyre and rim markings will help you make the right choice of tyre. The following radial-ply tyre size designations apply to your car:

220/55 VR 16 – front  
220/50 VR 16 – rear  
or 220/55 VR 390 TRX.

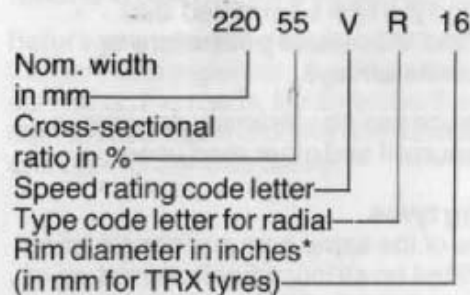

\* 1 inch = 25,4 mm

The speed rating code letters indicate the maximum permissible road speeds for tyres (subject to legal limits).

SR = up to 180 km/h  
HR = up to 210 km/h  
VR = over 210 km/h

We recommend the **exclusive use of BMW-approved tyres**. However, if another make of tyre is used, a confirmation should be obtained from the tyre manufacturer for models with a maximum speed in excess of 220 km/h that the tyres selected will withstand the loads occurring on the car.

**Important:** When renewing or changing tubeless tyres, always renew the rubber valve as a safety precaution.

See **Section 6** for the disc wheels and tyres which may be fitted on your car.

#### Wheel (rim) codes (example)

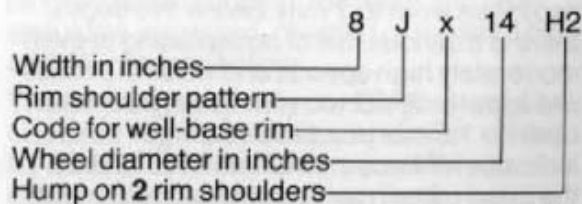

If, as a means of prolonging tyre life, you wish to have the **wheels changed round**, please bear the following in mind:

Due to the design principles of the front and rear axles and taking into account load and operating conditions, the front tyres reach their wear limit first on the shoulders and rear tyres in the centre of the tread. The higher the stresses (load, acceleration, lateral forces), the more wear will take place.

Changing the wheels from front to rear on the same side can in certain conditions have only a negligible effect on the service life whereas the handling and braking as well as the roadholding may be adversely affected. If so desired the spare wheel can also be put into use. In this case one must remember

that this wheel, possibly new, must be run in and will at first not have the same degree of adhesion. Changing the wheels round must be done on the same side and at short intervals (max. 5000 km). During the following period a difference in roadholding and straight running (possibly brakes pulling to one side, smaller contact surface of rear wheels on the road) must be allowed for.

In the interests of your safety and optimum running gear conditions we recommend that the wheels **should not be changed round**, because the increase in service life is negligible. With non-standard wheels and tyres the wheels and should definitely not be changed round.

**Max. 5000 km**

**Only if 220/55 VR 390 tyres are fitted.**

23 80 01 445 00

## Operating your BMW in winter

The winter months often bring with them severe changes in the weather, and you must not only adopt a correspondingly careful attitude to driving but also take a few precautions to ensure that your BMW comes through the winter months reliably and without breakdowns.

On winter roads, tyre grip is often very poor, and the driver must remember that braking distances are much greater than usual in many situations.

Before the cold season of the year commences, you are recommended to take your car to the BMW service station, for the necessary winter preparations to be carried out.

Note in addition the **engine oil specifications** for winter operation.

Do not wait until the next routine oil change to fill the engine with winter grade oil if the weather turns cold suddenly.

Apart from checking oil levels during a BMW Inspection, no special winter operating precautions are needed on the manual gearbox/automatic transmission, final drive, power steering, hydraulic brake system or self-levelling suspension.

The coolant on your BMW already contains a **long-term antifreeze and corrosion inhibitor**. To ensure full corrosion-proofing the concentration must be kept at 40% all the year round. This will provide antifreeze protection down to app.  $-27^{\circ}\text{C}$ .

Use only factory-approved long-term antifreeze and corrosion-inhibiting additives. Your BMW service station knows the approved grades.

**Renew the coolant every 2 year.** Check antifreeze concentration before and during the cold season. At the same time, inspect the cooling system for leaks and any coolant hoses which have become porous or brittle.

Engine temperature is regulated by the coolant thermostat according to outside temperature and engine load. For this reason, **no radiator blind should be fitted** or the radiator grille blanked off.

To keep the **windshield washer** operational in cold weather, add antifreeze to DIN 51 421 standard in accordance with the instructions issued by the supplier.

The engine will only start reliably if the **battery** is fully charged. Remember that a cold battery is less efficient, yet the demands made on it are more severe than in warm weather.

Use only factory-approved care products on the **locks**, to prevent unreliable operation\*.

If a lock should freeze despite this precaution, the key can be heated carefully before inserting and the lock thawed out in this way.

To prevent **rubber seals** on doors and lids from freezing, treat them with a rubber-care product\* or silicone spray\*.

The car's **paintwork**, as well as **chromium-plated or polished metal parts**, should be protected before and during the winter months with suitable bodywork care products\*.

**Have your BMW's brakes checked as a precaution before and after each winter driving period by the BMW service station. This work can usually be combined with whatever maintenance routine happens to fall due.**

**After starting a cold engine**, particularly at temperatures below  $-15^{\circ}\text{C}$  the gear shift may be stiff and the car's suspension fail to respond smoothly for the first few minutes of a journey, and other items of equipment may prove noisier in operation. This is unavoidable while the oil is still thick and viscous.

If the car is **immobilized** in deep snow, sand or soft ground, pack some form of material under the rear wheels to provide extra grip before the car digs itself in too far. If no other material is available, use the car's floor mats. If possible, obtain help to push the car back on to a firm surface. With a degree of skill, the car can be 'rocked' out of the holes: use a light throttle opening and select a forward gear and reverse in rapid succession, but avoid spinning the wheels, or the car will sink in deeper still. The handbrake can be applied lightly to prevent one rear wheel from spinning.

\* Available from your BMW dealer



Always keep the luggage compartment lid closed when on the move. This will prevent toxic exhaust gas from being drawn back in to the car's interior. If you are carrying bulky items and cannot close the lid, it is a good precaution to close all the windows including the sliding roof if fitted, and run the fresh air or heater blower at medium to high speed.

For extended periods of **foreign travel**, we recommend carrying a few spare parts on the car, for instance bulbs, fuses, V-belts, spark plugs, gaskets, etc. Your BMW service station will gladly advise you in selecting the essential items.

When taking the car abroad, the nationality disc must normally be displayed at the rear. In addition, many countries have specific regulations and laws which must be observed. Obtain details from car clubs, consulates, etc.

When crossing into a country with a different 'rule of the road', that is to say where the traffic drives on the opposite side to that used in your own country, the wedge-shaped sectors of the asymmetric-beam dipped (low) beam headlights should be covered with adhesive tape to prevent the upswept portion of the beam from dazzling oncoming traffic. The illustration below shows a right-hand drive car modified in this way for use in a country where they drive on the right side of the road.



# Trailer towing recommendations



- Trailer weight limits
- Trailer axles
- Trailer brakes
- Towbar nose wheel
- Towbar nose weight
- Trailer payload
- Stabilizing devices
- Weight guarantee
- Trailer coupling
- Trailer suspension
- Rear axle loads
- Headlight beam settings
- Outside mirrors
- Hill-climbing
- Tyre pressures
- Nationality plate
- Top speed
- Driving hints

23 83 01 448 00



## Towing a trailer with your BMW

Driving with a trailer always imposes more severe demands on both car and driver.

The trailer not only makes the car less manoeuvrable, but also restricts hill-climbing ability, acceleration and braking. The driver must make allowance for the outfit's changed ride and cornering ability under all operating conditions.

For troublefree towing, it is essential for the car and trailer to be perfectly matched together. When choosing a car specifically for towing, a heavier and more powerful model is preferable; the trailer, on the other hand, should be as light and compact as possible, consistent with your requirements.

The details below cover briefly all the main aspects of towing a trailer with your BMW automobile.

The **trailer weight limit** for your BMW is shown in **Section 6** and also on the registration document in some countries. The regular trailer weight has been chosen on the basis of thorough road testing so that it can be towed without difficulty under all conditions. Your BMW is powerful enough to cope easily with all traffic situations while towing this weight, and not to cause hindrance to other road users.

Up to this trailer weight, you can be sure that BMW's sheer driving pleasure will still be there for you to enjoy. But if you are forced to tow a higher weight than that specified for your car, it may be necessary to obtain a special permit from the licensing or vehicle inspection authorities.

The **maximum permissible trailer weight** for your BMW is shown in **Section 6**. This weight can be specified by the authorities and entered in the car's documents if the trailer coupling has been installed in accordance with the factory's recommendations, is type-approved and authorized for the maximum weight.

However, it is best to tow the maximum trailer weight only in exceptional circumstances, and to exercise special care and concentration when towing this weight.

The **number of trailer axles** will often be governed directly by trailer weight. There are single-axle and two-axle or tandem-axle trailers. In the Federal Republic of Germany tandem-axle trailers may only be pulled by holders of an automobile driving licence if the distance between the axle centres does not exceed 1000 mm; please check your local or national regulations in this respect.

**Single-axle trailers** are easier to manoeuvre by hand or with the car, and have a relatively low rate of tyre wear.

**Tandem-axle trailers** possess greater directional stability and a lower nose weight (towbar downthrust). However, more skill and strength are required to manoeuvre them. The use of two unsteered axles increases tyre wear slightly.

For your own safety, the trailer should have an independent **brake for normal driving, and a parking brake** for use when manoeuvring by hand and parking the trailer.

The load-sensitive **overrun brake** has by now reached a high technical standard. When the car's speed is reduced the trailer tries to overrun it, whereupon the brake is applied. The overrun force is transmitted

directly, but is damped mechanically or hydraulically to reduce jerking to a minimum.

The variable-height **jockey wheel** must be of adequate size so that the trailer moves easily when manoeuvred by hand.

Please make sure that the trailer's specification always includes two **wheel chocks**, to provide an additional safeguard against rolling away (as well as the parking brake) when parked temporarily. The **nose weight** or towbar downthrust is the load exerted vertically downwards by the trailer towbar on the ball end of the car's trailer coupling.

The maximum nose weight of 50 kg should not be exceeded. However, on cars with self-levelling rear suspension, an increase in nose weight to 65 kg is permissible. In the interests of road safety and for design reasons, do not exceed these maximum values.

Since the driver of the outfit will be held responsible if the nose weight is exceeded, it is good practice to measure it with bathroom scales or by some similar means before attaching the trailer to the car. You can correct the nose weight by redistributing the load inside the trailer slightly.

The **trailer payload** or the contents of the caravan trailer must be carefully stowed to ensure that the trailer runs true (without snaking) and does not jerk the car. Lighter items (cushions, pillows, bed linen, etc.) should be stowed at the extreme front and rear. **Heavier items such as extension tent poles, and movable items of furniture must be stowed at floor level above the trailer axle(s), and lashed down to prevent them from slipping. The lower the trailer's centre of gravity, the more**

**stable it will be and the greater the safety of the complete outfit when on the move.**

When loading the trailer, make sure that you do not exceed the gross weight limit or the axle-load limits of either the trailer or the car's rear axle. The limit in practice is whichever of these values is reached first.

When towing a trailer, you must remember to **deduct the effective nose weight from the car's gross weight and rear axle load limit** before loading the car's luggage compartment.

The correct **trailer coupling** for your BMW (with either fixed or detachable ball head) can be ordered as a factory-fitted option or installed subsequently as a BMW accessory.

For later installation, be sure to specify only a genuine BMW-approved and tested trailer coupling, and have it fitted by your BMW dealer or authorized BMW service station

This is your guarantee that the trailer coupling has been designed, tested and manufactured with the same care as the remaining components of your BMW. If the licensing authorities require the trailer coupling to be inspected and entered in the car's documents, the procedure will be simplified if a genuine BMW-approved installation has been specified.

Before you acquire a trailer it may be good practice to obtain a **warranty statement** from the manufacturer as to the **effective trailer weight** and **permissible payload**.

**Stabilizing devices** can be installed to improve the outfit's straight-line running and reduce snaking and pitching movements. They can be purchased from specialist dealers, but make sure that the device you intend to install is type-approved or has a general operating permit.

**Self-levelling rear suspension** is the ideal solution for trailer towing. Unless the rear axle load limit is exceeded, the car always returns to the correct static ride height regardless of the load carried and whether the trailer is attached or not.

BMW does not officially approve any other suspension devices or systems sold by the automotive accessory trade.

When **loading the car** prior to towing a trailer, please remember that its bodywork, suspension and brakes will be exposed to far greater loads than when driving solo. Note in particular that heavy loads placed in the car's luggage compartment must be added to the towbar nose weight at the trailer coupling (ball head). Taken together, these loads must not cause the car's **rear axle load limit** to be exceeded. Heavy items must be located over the trailer axle and lashed securely to prevent slip. Always remember: careful load distribution on the car and the trailer may be vital for your safety, and is certainly the secret of effortless driving with a trailer on long journeys.

If carrying a load on the roof rack, keep the surface area of the luggage as small as possible. On no account is the **maximum roof load** specified for your BMW to be exceeded.

This car is equipped with self-levelling rear suspension and the headlight beams need not be reset.

If the standard **rear-view mirrors** cannot be used when the trailer is attached, the law requires two suitable outside mirrors to be attached to the car. They must enable the driver to see both rear corners of the trailer. Your BMW dealer can supply and install suitable mirrors, including types with

adjustable arms or detachable for driving without the trailer.

The **maximum gradient** laid down for your BMW is restricted, in the interests of unobstructed traffic flow and maximum road safety, to 12% (1 in 8,3) or, with trailers of greater weight, to 8% (1 in 12,5). You must therefore be in possession of maps showing maximum road gradients before starting a journey in hilly or mountainous regions. Such maps can be obtained from car, touring or caravan clubs.

Remember that you must allow not only for maximum uphill gradients so that the outfit can always be restarted successfully, but also for steep downhill gradients so that the trailer brakes are not overloaded. Before descending a steep gradient, always select a lower gear or speed range in good time, and reduce before the gradient steepens. Apply the foot brake for brief periods at a time to prevent fade.

Your car has the BMW **antilock braking system (ABS)**, avoid heavy brake applications during which the ABS comes into action. Gradual braking will significantly reduce your stopping distance, especially on low-friction road surfaces.

Before starting a journey on which steep gradients are likely to be encountered, an authorized service station should always check the serviceability of the trailer brakes.

**Tyre pressures** must be raised to the specified values before starting a journey with the trailer. Comply with the trailer manufacturer's tyre pressure instructions.

The condition and pressure of the tyres are factors which not only govern tyre life but also influence road safety to a decisive extent.

Check operation of the **trailer rear lights** before starting every journey.

**Nobody is permitted to remain inside the trailer when the outfit is being driven.**

For journeys abroad, you must display an **international identification plate** of the country where the outfit is licensed, at the rear of the car and of the trailer.

The **maximum speed limit** when towing a trailer in the Republic of South Africa is 80 km/h on both freeways and ordinary main roads. This is also the maximum speed limit recommended for your BMW with trailer. If higher speed limits are imposed in other countries, you are still recommended not to exceed 80 km/h for road safety reasons.

**Driving hints for trailer towing**

For your own safety and that of other road users, you must exercise particular care and concentration when towing a trailer. Long journeys should be carefully planned and prepared for, allowing plenty of time before and during the actual journey.

Remember that even quite a small trailer makes the car distinctly less manoeuvrable, puts up the overall weight and is more difficult to control, particularly on steep downhill gradients. Sensitivity to side winds and the suction effect created when overtaking or being overtaken by large trucks are more severe, and must always be allowed for.

Never tackle a lengthy journey with a new trailer unless you have practised driving the outfit for some distance previously. You must familiarize yourself with the way the outfit responds to brake applications, to its cornering ability, the effects of side winds, the reduced acceleration and the problems of manoeuvring in confined spaces. Practice estimating the outfit's overall length and positioning it with the aid of the outside mirrors.

Before the journey starts, have the car and trailer checked over for serviceability, and get your local service station to put right any minor defects which are discovered.

Your driving speed should be matched to traffic, weather and road conditions. Never disregard these factors on account of supposed urgency. It is vital to start a long journey in a relaxed, rested mental and physical condition. Allow lengthy breaks in the journey and include sufficient time for unforeseen holdups or traffic jams. Experienced drivers of trailer outfits know the truth of the old saying "More haste, less speed".

The design and construction of your BMW automobile take into account every possible factor likely to contribute to trouble free trailer towing. Remember, though, that these built-in reserves of engine power, torque, handling and braking should not be wasted by driving too hard or without due care and attention.



# Care of your BMW – minor defects and repair hints **5**



General care of the car

Laying up out of use

Wheel-changing

Starting difficulties

Coolant temperature

Brakes

Check-Control

Warning lights

Power steering

Toolkit

Towing, starting with  
a flat battery

BMW Emergency Service

Wipers

Manual operation of electric  
special equipment options

Fuses

Bulb-changing

Trouble-shooting

23 81 07 500 00



## Care of the car

Your brand-new BMW is a splendid sight. Whether it stays that way, perhaps even for many years, will depend on you and the care you are prepared to take.

The manufacturer has used careful design techniques and the latest production methods to ensure that general upkeep of the car is simplified. The paintwork consists of several layers for maximum protection, and after it has been applied the body cavities are electrophoretically dip coated with specially-developed sealants. The entire underside of the car is sprayed with resilient PVC material, followed by a wax-based underseal.

Every 12 months, during the annual check, the bodywork should be inspected by your BMW service station.

Road dust and dirt, the airborne deposits encountered in industrial areas such as fly ash, lime and soot, but even tar stains, dead insects, bird droppings, agricultural deposits accompanied by a high level of alkali formation (dung, animal manure), and the stains left when the car is parked under trees all contain various chemicals which, if allowed to remain on for a long time, can damage the paintwork in the form of patches, blisters, corrosion, flaking paintwork and similar. The car should therefore be washed as often as convenient.

Damage to the paintwork caused by flying stones should be cleaned off or touched in to prevent rust patches.

In the same way, overflowing fuel, oil, grease or brake fluid can discolour or damage the paint finish and should be **cleaned off immediately**.

Frequent washing with clean water will help to harden new paintwork.

**Washing the car** should be postponed while the engine compartment lid is still hot or if the car has stood exposed to bright sunlight for some time already. This precaution will avoid patches forming.

Clean the car's interior with a hand brush or a vacuum cleaner.

Moisten dirt on the paintwork with a finely dispersed jet of water, then rinse off. Do not direct the water spray into the air entry grilles and outlets of the heating and ventilation system.

After spraying down, wash the upper part of the body with a sponge, washleather glove or similar, using an abundant supply of no more than luke-warm water, and starting with the roof. Rinse out the sponge frequently.

Wash the lower part of the body and the wheels last of all, if possible keeping a separate sponge just for these areas.

After washing down, rise the car down again thoroughly with the hose and leather dry with a clean chamois leather to prevent discoloured patches where the water was not removed.

If washing with clean water is not sufficient, a brand-name car shampoo can be used in the concentration recommended by its manufacturer. Rinse down afterwards with a generous flow of water. Remember that too frequent use of powerful car shampoo or similar products will remove fats from the

paintwork and make it brittle. This effect can be combated by applying a reputable paint preservative.

If the car is put through an **automatic car wash**, try to choose one without excessive brush pressure and with an ample flow of water for rinsing. Most of the more recent car washes fulfil these requirements.

Particularly during the cold season of the year you should try to ensure that the car is washed more frequently, since heavy dirt deposits are more difficult than usual to remove and will also damage the paint surface.

Note: after washing, the brakes may be wet and therefore less effective in action. Apply them briefly to dry the discs.

It is quite easy to decide when the car needs polish or preservative treatment: the water no longer forms round droplets and rolls off the surface.

Please use only reputable car products and keep to the manufacturers' instructions.

**Minor paint damage** can be touched up with a BMW paintwork repair stick, which is used like a brush. The correct paint colour designation is on an adhesive label close to the maker's plate.

**Chromium-plated and polished metal parts** should be cleaned regularly with water, to which a car shampoo can be added if required.

**Aluminium wheels** should be cleaned with a special detergent product\*, particularly in winter; do not use any aggressive-action products containing acids or abrasives, nor a steam jet.

**Tar stains** should be removed without delay using a commercially available tar stain

remover, never with a knife blade or other sharp object.

**Mirrors** should not be cleaned with agents such as polishing paste which contain quartz, but only with water or a soap and water solution.

**Rubber components** should only be cleaned with water or treated with a rubber cleanser or silicone spray.

**Plastic components, lamp glasses** and items sprayed matt black should be cleaned with water, to which a car shampoo may be added; plastic surfaces can be treated with a plastic cleanser if desired. Never use solvents such as nitro thinners, cold cleanser, petrol or similar.

To clean the **insides of the windows** we recommend a 1:1 mixture of water and vinegar.

Clean the **wiper blades** with soapy water. The wiper blades should be renewed twice a year, before and after the cold season.

The **seat upholstery becomes electrostatically charged**, particularly when atmospheric humidity is low, so that there is a risk of the car's occupants receiving an unpleasant but entirely harmless electric shock if they touch any metal parts **after** leaving the car. However, by holding on to a metal surface **while leaving the car**, the electric charge is dissipated and no shock results.

**Stains on the interior trim and upholstery** – except for leather – should be removed with a commercial foam spray.

Brush down fabric surfaces afterwards.

**Wear patches on corduroy or velour fabrics** are caused during frequent use by pressure allied to heat and damp, and

should be brushed 'against the pile' with a slightly moist brush.

**Seat belts** should only be cleaned with a weak solution without removal from the car. Never attempt chemical or dry-cleaning or else the fabric of the belts may be damaged.

Never allow **automatic (inertia-lock) seat belts** to retract while they are still wet. Clean the seat belts if they become dirty or muddy, as dirt penetrating the reel mechanisms could prevent them from locking or keeping the belts taut and thus constitute a safety risk.

**Floor mats** can be removed for cleaning the interior of the car. Raise the fasteners, separate them and lift out the mat (do not use undue force). After inserting the mats again, press down on the fasteners to retain the mats firmly.

The car's **radio antenna** should be kept clean to ensure good reception, and can be given a coating of special antenna grease to protect it from the weather.

**Important:** this treatment is particularly advisable on motor-driven antennas.

On **radios with a cassette player**, clean the playback head after every 100 hours of operation with a cotton-wool stick soaked in methylated spirit or pure alcohol. Run a head cleaning cassette through the machine if available, but never clean the tape heads with a metal object.

The **upholstery leather** used by BMW on its cars is a high-grade natural product treated by the latest processes. If carefully looked after, it will retain its high quality for many years.

Regular cleaning and general care is essential, since dust and road dirt penetrate

the pores and creases and cause the surface to wear away and become brittle.

Clean the leather surfaces with a slightly moist cotton or wollen cloth, but do not soak the leather right through at the seams. Dry the leather and rub it with a clean, soft cloth.

Very dirty areas on leather upholstery can be cleaned with a mild detergent (suitable for woollens) containing no brightening agents. Use two tablespoons to one litre of water. Dab grease or oil spots carefully with benzine, but do not rub.

To maintain the condition of the leather after cleaning, and avoid the build-up of a static charge, apply 'Karneol'. Shake well and apply a thin coat with a soft cloth. Allow to dry, then rub with a clean, soft cloth.

This treatment should be repeated every six months if the leather is exposed to normal use.

### Storage out of use

If the car is to be laid up out of use for **more than three months**, we recommend that the following **maintenance work** be performed by your BMW service station in order to prevent deterioration during the storage period.

1. Was the body and the underside of the car, clean the interior and finally polish the paintwork and clean chrome-plated parts. Clean rubber seals on lids and doors and rub them with talc or glycerin. If necessary, have the body cavity sealing treatment repeated and the underseal renewed in accordance with BMW factory recommendations.
2. Change the engine oil and renew the oil filter element while the engine is at normal operating temperature. As an additional anti-corrosion measure, a corrosion inhibitor, e.g. Autol-Desolite or similar, can be added to the engine oil as specified by the supplier.
3. Check coolant level and concentration, and top up if necessary.
4. Check acid level in battery cells and top up with distilled water if necessary.
5. Drain the windshield washer fluid tank and lines.
6. The fuel tank should be filled, to prevent corrosion caused by moisture condensation.
7. Increase tyre pressures to 4 bars.

Immediately before the car is taken out of use, apply the foot brake and the handbrake until warm, so that the pads and linings are dry and the brake discs and drums cannot corrode.

Store the car in a dry, well-ventilated space. Engage reverse gear. Do not apply the handbrake. If necessary, chock a wheel to prevent rolling away.

Disconnect the negative lead from the battery. If there is any risk of frost, remove the battery and store in a warmer place. The battery must be recharged at least every six months or it will become unsuitable for further use.

The air-conditioning must be run briefly at least once a month at an ambient temperature of at least +5 °C (this is particularly important in the cold season of the year), or else the compressor shaft seals may dry out and permit refrigerant to leak. The engine should be run for this purpose until it reaches its normal operating temperature (coolant thermometer needle approximately midway between the two coloured zones). This will avoid condensate formation and the risk of internal engine corrosion. If the car is not equipped with air-conditioning, do not run the engine during the storage period.

Note that if the car's registration was allowed to lapse or the car was officially taken out of use, the proper legal procedure and the time limits for re-registration must be carefully observed, or else the car's general operating permit may become invalid. Comply with your national regulations.

### Restoring car to use

First recharge the battery, or renew it if necessary.

An authorized BMW service station should then perform Inspection 1, if necessary including the Annual Check.



## What to do if . . .

If your car should develop a fault, there are certain steps you can take yourself if beyond reach of a service station.

Flat tyres are fortunately a rare event nowadays. Should you have the misfortune to suffer a puncture, drive the car away from the main traffic stream and apply the handbrake. Comply with local regulations concerning the protection of broken-down vehicles by switching on the **hazard warning flashers**.



The **spare wheel** is located in the luggage compartment, standing in the spare wheel well on the right, underneath a carpet cover. The T-screw with bar holding the wheel can be released by hand. The spare wheel can only be used in emergency cases on the rear axle and must be driven at low speed to the nearest service station, to be repaired. (Not necessary when car is fitted with 165 TR 390 rims with 220/55 VR 390 tyres.)

The **jack** and **wheel stud wrench** are housed in a compartment on the right side of the luggage compartment under a cover. The jack can be lifted out after removing the wing nut. To prevent noise when the jack is stored in the luggage compartment again, it must be retracted fully and secured with the wing nut in its original position.



**If you use your BMW for trade purposes, for example as a taxi or hire car, comply with the appropriate accident prevention regulations for winches, hoisting and traction equipment.**

**Loosen the wheel nuts. On TRX wheels, take out the badge after releasing the spring.**

**Warning** place the wheel chock behind the opposite rear wheel to prevent the car from rolling back when it is raised on the jack (this is necessary on account of the handbrake design. The wheel chock is firmly located in the luggage compartment to prevent noise.



Attach the jack to one of the **four pickup points** provided on the body (the one nearest the punctured wheel) and jack up the car until the wheel is well clear of the ground.

**Warning: never lie under a jacked-up vehicle, in case it should fall on you.**



Unscrew the wheel studs and change over the wheels. To fit the spare wheel, insert the centering pin from the toolkit into one of the holes, mount the wheel on to the pin, screw in one wheel stud, then remove the centering pin. Screw in the remaining wheel studs and tighten them uniformly.



Lower the car from the jack, tighten the wheel studs finally in a crosswise pattern (first one stud, then another on the opposite side of the hub) and have the tightening torques checked at the earliest opportunity.

Check tightening torque after 1000 km when a new wheel is fitted for the first time (e.g. spare wheel).

Have the flat tyre repaired and the wheel and tyre rebalanced as soon as possible.

Tyre repairs should always be entrusted to a BMW service station or a specialist tyre dealer capable of examining the tyre to determine the full extent of possible concealed damage.

**Important:** when removing or renewing tubeless tyres, the rubber valve must also be renewed as a safety precaution.

When fitting other than genuine BMW light-alloy wheels, it may be necessary to use the corresponding wheel bolts instead of genuine BMW wheel bolts.

## Starting difficulties

### **Starter motor does not turn in ignition key position 3:**

Test by turning on the car's headlights then operating the starter again.

1. If the lights go out slowly, the battery needs charging or is faulty. Have the battery recharged or renewed. If necessary, start the engine by towing the car (manual gearbox only) or with jumper cables from another battery. See descriptions under "Tow-starting" and "Starting with flat battery".

**Cars with automatic transmission** cannot be tow-started or push-started. Start the engine in an emergency with jumper cables from a second battery. See "Starting with flat battery".

2. If the lights go out immediately, check that the cables at the battery and starter are making good contact, and take up slack if necessary.
3. If the headlights remain bright, consult a BMW service station (the starter is not operating correctly).

### **Engine does not start although starter motor is operating correctly:**

If the correct starting instructions were followed and there is sufficient fuel in the tank, the fault may lie in the ignition system or in the fuel supply.

1. Check that the spark plug caps are properly attached to the spark plugs and that all cables at the coil, distributor and connecting plugs are secured tightly. The fault could also be due to water entering the engine compartment when the car was washed.
2. Unscrew and remove the spark plugs and clean and dry them if necessary. Check the electrode gaps. Insert and tighten the spark plugs and attach the leads.
3. If the engine does not start, renew the spark plugs.

4. If this also proves ineffective, inspect the complete ignition system or have it examined by a BMW service station.

### **Warning: ignition system:**

This is a high-performance ignition system, and any contact with 'live' components when the engine is running could lead to a fatal electric shock.

5. Check that fuel is supplied at starting speed. To confirm this, compress the fuel hose to the cold-start valve firmly between the fingers. Run the starter: a considerable build-up of pressure should be detected.

If no fuel is being supplied, check the corresponding fuse (for the fuel pump). If it is intact, consult a BMW service station.

The fuel lines for the fuel injection system do not have to be bled, as this takes place automatically by way of the fuel delivery pump when the starter is operated.

**If coolant temperature is too high:**

1. Allow the engine to cool down until the thermometer needle is approximately midway between the two coloured zones, and check coolant level. **Never add water if the cooling system is still hot** and coolant has been lost: allow the engine to cool down first until a hand can be placed on the engine block.
2. If coolant is lost, examine the cooling system for signs of leakage.
3. Check condition of V-belt and either retension or renew if necessary.
4. Have the ignition timing checked.
5. If necessary, have the cooling system cleaned out by a BMW service station.

**Brake system malfunctions:**

**If the brakes develop a fault, you are recommended to contact an authorized BMW workshop without delay.**

If the **red brake pad wear warning light** comes on when the brakes are applied, the disc brake pads must be renewed as soon as possible.

If the warning light remains on after starting the engine or when the car is in motion, the brake pads have reached their **wear limit**, and must be renewed immediately.

A spreader spring in each brake caliper **increases the brake pedal effort** required when the **minimum brake pad thickness** is reached.

**Important: when renewing brake pads and linings, use only the products approved by BMW, or else the car's general operating permit will be rendered invalid.**

If the **red brake warning light** comes on during a journey, there has been a loss of brake fluid or system pressure (**increased pedal effort needed**).

If **one circuit** of the hydraulic **diagonally-split dual-circuit brake system** should fail, **pedal travel** will immediately **increase**. Increased **pedal effort** will be needed to obtain the equivalent braking effect. Although the car can still be braked satisfactorily with only one circuit in operation, a BMW service workshop should none the less be consulted immediately.

If the **ABS warning light** comes on when the car is in motion, this indicates that the antilock braking system has developed a **fault and is out of action**. Although the antilock braking effect is then lost, normal brake applications can still be made.



Faults recorded by the **Check-Control** system can be put right as follows:

1. **Brake light:** renew either the corresponding fuse or the 21 watt spherical bulb.
2. **Low beam headlights:** renew either the corresponding fuse or the 60/55 watt H 4 bulb.
3. **Engine oil:** check level at dipstick and add more oil of the same grade.
4. **Rear lights:** renew either the corresponding fuse or the 5 watt spherical bulb.
5. **Licence plate lights:** renew either the corresponding fuse or the 5 watt festoon-type bulb.
6. **Windshield washer fluid:** refill the fluid reservoir; if necessary, restore the correct antifreeze concentration.



7. **Coolant:** check level and top up if necessary. After this, the concentration of the long-term antifreeze and corrosion inhibitor should be checked by a BMW service station.

If the **red oil pressure warning lamp** comes on while driving, declutch **immediately** and switch off the ignition. If the engine oil level appears to be correct, consult a BMW service station. If the warning lamp comes on briefly at idle speed this need cause no alarm provided that it is extinguished when the accelerator is pressed down.

If the **red battery charge tell-tale lamp** comes on during a journey, take the car to a BMW service station as soon as possible or else the battery will gradually go flat.

If the **Service Interval Indicator** is displaying an illogical reading, for instance the green and red LEDs at the same time, or if there is no display, consult a BMW service station.

If the speedometer should develop a fault, the Service Interval Indicator will probably cease to operate correctly as well, since it depends on correct speed, distance and temperature readings. The fault must be rectified by a BMW service station.

#### **Power steering malfunctions:**

##### **Steering stiff to turn left or right:**

Too little oil in system. Check oil level (see **Section 4**) and if necessary have the steering gear examined for leaks and signs of damage.

The V-belt driving the steering pump may be slack or damaged. Correct tension or renew V-belt.

If the red brake warning light comes on, pressure may have been lost from the system; take the car to a BMW service station.

##### **Steering stiff if wheel is turned too quickly:**

Insufficient V-belt tension, V-belt damaged. Adjust V-belt tension or renew V-belt.

##### **Unusual noises:**

Too little oil in system. Add oil and check steering for leaks.

If none of these procedures improve the situation, always have the power steering examined by a BMW service station.



**The toolkit:**

Is in a tray under the luggage compartment lid, which swings down when the retaining screw is undone.



23 80 01 534 00

**Towing facilities:**

Use only **nylon towropes** or straps which are sufficiently resilient to protect both vehicles against sudden jerking. Steel wire cables or towbars are not suitable.



23 83 01 535 00

If you wish to assist another driver by towing his vehicle with your BMW, make quite sure that the broken-down vehicle's weight does not exceed that of your own car.



23 77 01 536 00

**Tow-starting**

Switch on the ignition, select 3rd gear and release the clutch.

Switch on the hazard warning flashers.

When the car is moving at a fair speed, engage the clutch. After the engine has started, declutch again and allow the engine to idle. Switch off the hazard warning flashers. The cause of poor starting should be investigated and put right by the nearest BMW service station.

**Cars with automatic transmission cannot be tow-started:** proceed as described in "Starting with flat battery" (next page).

**Towing away**

If vehicle has to be towed away, turn ignition key to position "1" so that the brake and turn indicator lights are on and the horn and wipers can be used.

Switch on the hazard warning flashers.

If the car's electrical system is out of action, the towed vehicle must be identified (for instance with a notice or by placing the warning triangle in the window) so that following vehicles are warned.

**Towing – BMW models with automatic transmission**

If the car has to be towed, the selector lever must be at "N" = neutral.

Towing speed should not exceed 50 km/h and the towing distance should be limited to 40-50 km. To tow an automatic transmission car more than 50 km, add 1 litre of ATF to the contents of the transmission, or remove the propeller shaft. After the car has been repaired, do not forget to reduce the fluid level in the transmission to normal.

### Starting with a flat battery

If the car's battery is run down, the engine can still be started by running "jumper" cables (BMW accessory) to the battery from a second vehicle.

1. Check that the second car has a 12-Volt electrical system and a battery of approximately the same capacity in A.h (this will be marked or printed on the battery).
2. Leave the flat battery connected.
3. Do not allow the bodywork of the two vehicles to touch anywhere, or a short-circuit may be caused.
4. First connect the positive terminals of the car's batteries together. Then connect the second jumper cable to the negative post of the second car's battery and to some part of the bodywork or engine block of your car, as far away from the battery as possible.

5. If the battery of the second vehicle is not too powerful, run the engine to boost the charge. Start your own car's engine in the usual way, and keep it running. When your car's engine is running, switch on the lighting, heated rear window and maximum blower stage **prior to disconnecting the jumper cables**, in order to avoid over-voltage between the governor and the consumers. Disconnect the jumper cables in the opposite order to that described above. Do not forget to trace the cause of the flat battery, and have the battery recharged.



ZA 23 77 01 541 00

To remove a **wiper blade**, swing the arm away from the windshield. Press the retaining spring and pull the blade away from the arm.

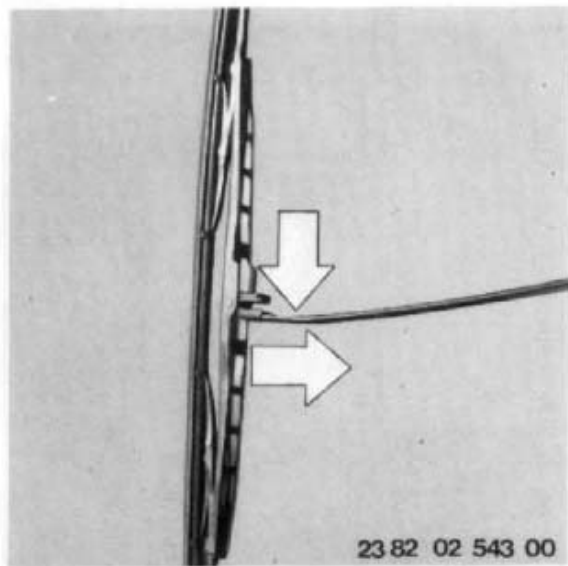

The complete **wiper arm** can be pulled off by swinging up the plastic cap and unscrewing the retaining nut (13 mm wrench).

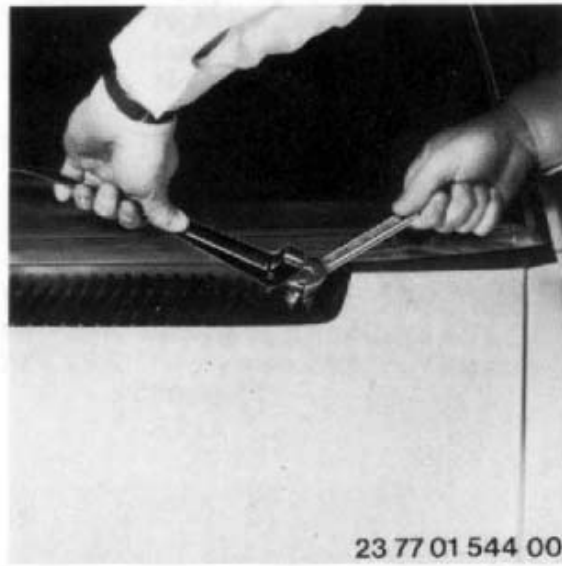

If the electric motor drive for the **sliding/vent roof** should fail, the roof can be operated mechanically as follows: remove the cap, unscrew the nut with a spark plug wrench and turn the sliding/vent roof in the required direction using an Allen key.

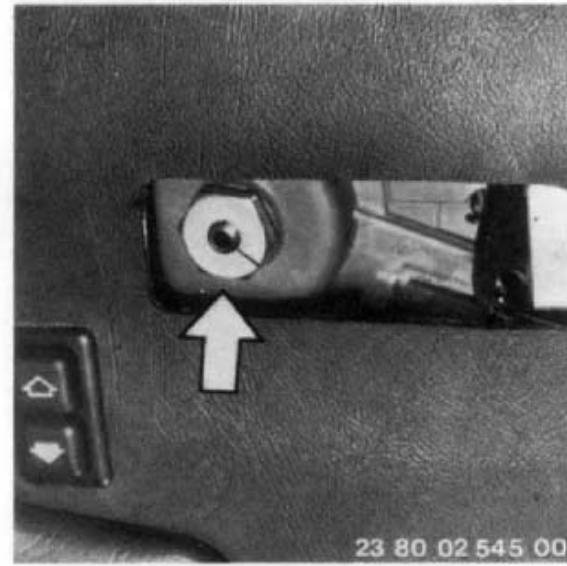



The **fuel filler flap** can be opened if the central locking system should fail by pressing back the locking rod. This is reached by removing the left luggage compartment lining panel.

On models with self-levelling suspension, the locking rod is accessible through an opening in the web plate covered by the preformed side carpeting (see photo).

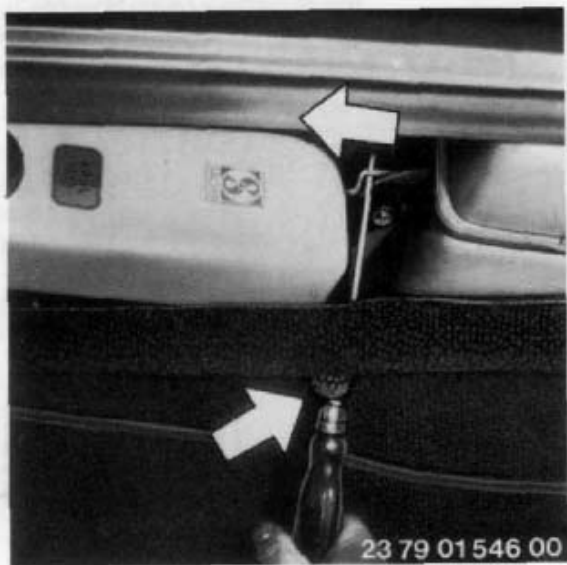

If any electrical equipment on your car should fail, first check the fuses.

The **fuse box** (power distribution box) with spare fuses, relays and plastic pincers is located on the left inside the engine compartment. It is accessible when the engine compartment is open.

Take off the fuse box cover and pull the blown fuse out of its socket, using the plastic pincers. If the metal strip inside the transparent fuse is melted, the fuse must be replaced.

Never replace blown fuses with wire or attempt to repair them in any way (risk of fire). If the fuse blows repeatedly, have the cause traced and put right by a BMW service workshop.



### Ratings in amperes, equipment supplied and relays

- 1 = 7,5 A Left high-beam headlight (relay K 3)
- 2 = 7,5 A Right hand-beam headlight (relay K 3)
- 3 = 25 A Auxiliary fan, 91 °C (relay K 1)
- 4 = 15 A Turn indicators
- 5 = 25 A Wipe-wash, and intensive windshield cleaning systems (relay K 10)
- 6 = 7,5 A Stop light (15 A with additional stop lights), automatic cruise control.
- 7 = 15 A Horn, twin-tone horns (relay K 2)
- 8 = Amplifier
- 9 = 15 A Engine electrics
- 10 = 7,5 A Instruments, on-board computer, Check-Control
- 11 = 15 A Fuel pump/deliver pump
- 12 = 7,5 A Radio
- 13 = 7,5 A Left low-beam headlight (relay K 4)
- 14 = 15 A Right low-beam headlight (relay K 4)
- 15 = Not in use
- 16 = 30 A Heater blower (relay K 5)
- 17 = 15 A Reversing (backup) light, remote-control mirrors, mirror heating, fan control, air-conditioning, first and second stage of temperature switch.
- 18 = 30 A Auxiliary fan, 99 °C (relay K 6)
- 19 = 25 A Sliding/vent roof (relay K 7)
- 20 = 25 A Rear window heating elements (relay K 7)

- 21 = 7,5 A Interior, glove box and luggage compartment lights, hand lamp, clock, radio memory, on-board computer
- 22 = 7,5 A Side, rear and parking lights (left) rear fog lights
- 23 = 7,5 A Side, rear and parking lights (right), licence plate and instrument lighting make-up mirror and engine-compartment lighting
- 24 = 15 A Hazard warning flashers
- 25 = 30 A Self-levelling suspension
- 26 = 30 A Seat adjustment, electric windows
- 27 = 25 A Central locking, door lock heating.
- 28 = 25 A Cigarette lighter, power radio antenna.
- 29 = 7,5 A Left fog light (relay K 8)
- 30 = 7,5 A Right fog light (relay K 8)

When **changing bulbs** or performing any other minor jobs on the electrical system, avoid short circuits by leaving the item concerned switched off and disconnecting the negative lead at the battery (ground to earth lead).

**Do not hold new bulbs between the fingers** or grease will be deposited on the glass; use only a clean cloth, paper handkerchief or similar.

When replacing headlight bulbs, make sure that the beam alignment screws are not disturbed.

For use in an emergency we recommend carrying a BMW spares pack in the car. Your BMW authorized dealer will gladly provide details.

The outer headlight units contain the **low (dipped) beam and side/parking light bulbs**

Open the engine compartment and remove the plastic cover from the rear of the headlight unit.

Turn the cap to release it, and remove the cover. Release the wire spring clip and renew the 60/55 watt H 4 bulb.

The 4 watt **side/parking light bulb** is also accessible, and can be pulled out of the reflector if it has to be renewed.



23 77 01 552 00

The **high beam headlights** are the inner units and come on in addition to the outer headlights.

Open the engine compartment and remove the plastic cap from the rear of the headlight unit.

Turn the cover counterclockwise to release it, release the wire spring clip and renew the 55 watt H 1 bulb.



23 77 01 553 00

### Front flashing turn indicators

Remove the two Philips-head screws and take off the plastic lens. Press the 21 watt spherical bulb in gently and turn to remove.

### Front fog lights

Remove the Philips-head screw and housing. Release the wire spring clip and renew the 55 watt H 3 bulb



### Rear lights:

Open the luggage compartment, unscrew the four knurled nuts in the openings of the rear lining panel using the spark-plug wrench and lift off the lens assembly. Remove the blown bulb from its holder.

The side/parking and rear lights have spherical bulbs rated at 5 watts; the remaining spherical bulbs are rated at 21 watts.



### Licence plate lights:

Remove the two Philips head screws and take off the lens frame with rubber seal. The contact blades for the 5 watt festoon-type bulb must make good spring contact and the metal surfaces must be clean. If necessary, clean and bend in the contact blades.





**Interior light:**

After pulling out the interior light assembly, the two 10 watt festoon-type bulbs become accessible.

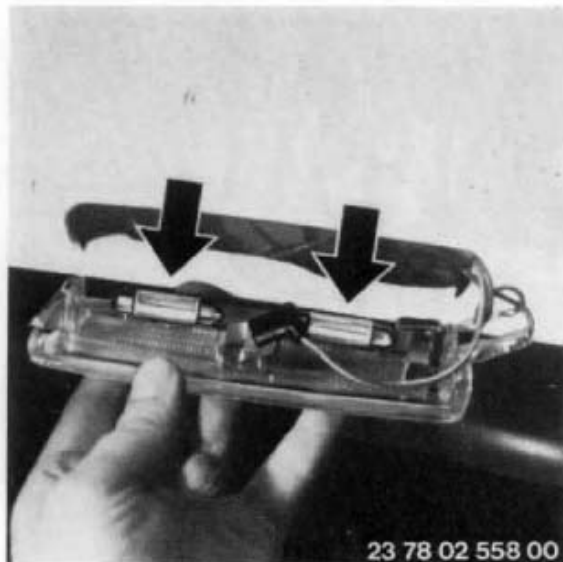

**Luggage compartment light, engine compartment light**

The 5 watt festoon-type bulb can be reached after pulling out the luggage compartment light assembly.



<b>Minor defects – troubleshooting</b>	<b>Cause</b>	<b>Remedy</b>
Engine will not start	Battery flat, battery terminal clamps loose, selector lever (automatic transmission) not in "N" or "P"	See pages 4-14 and 5-7
Starter runs but engine will not start	Fuel tank empty, loose ignition leads (no spark at plugs), engine flooded (mixture too rich)	See page 5-7
Engine starts but immediately stalls	Vacuum hoses loose or leaking; fuel injection leads loose	See page 5-7; consult BMW service station if necessary
Uneven idling	Idle setting incorrect, misfiring or incorrect ignition timing	Have engine settings corrected by BMW service station
Oil pressure warning light comes on	Engine oil level too low, oil leak; oil filter blocked or leaking	See pages 4-10 and 5-9; consult BMW service station
Coolant temperature reading too high	Coolant level too low; V-belt slack or defective	See pages 4-13 and 5-8
Battery charge warning light comes on	V-belt slack or defective, alternator or regulator cable connections loose	See page 5-9; if necessary consult BMW service station
Brake pad wear indicating light comes on	Brake pads have reached wear limit	See page 5-8; have pads renewed by BMW service station
Antilock braking system (ABS) warning light comes on	ABS has developed a fault and is out of action	See page 5-8
Brake warning light comes on	Loss of brake fluid or system pressure; one brake circuit has failed; V-belt slack or defective	Have brakes checked immediately by BMW service station and repaired if necessary
Power steering stiff to turn	Oil level too low; V-belt slack or defective	See page 5-9
Central warning light flashing	A system fault has developed; trace with Active Check-Control	See page 5-9

**Warning: ignition system:** This is a high-performance ignition system, and any contact with "live" components when the engine is running could cause a fatal electric shock.

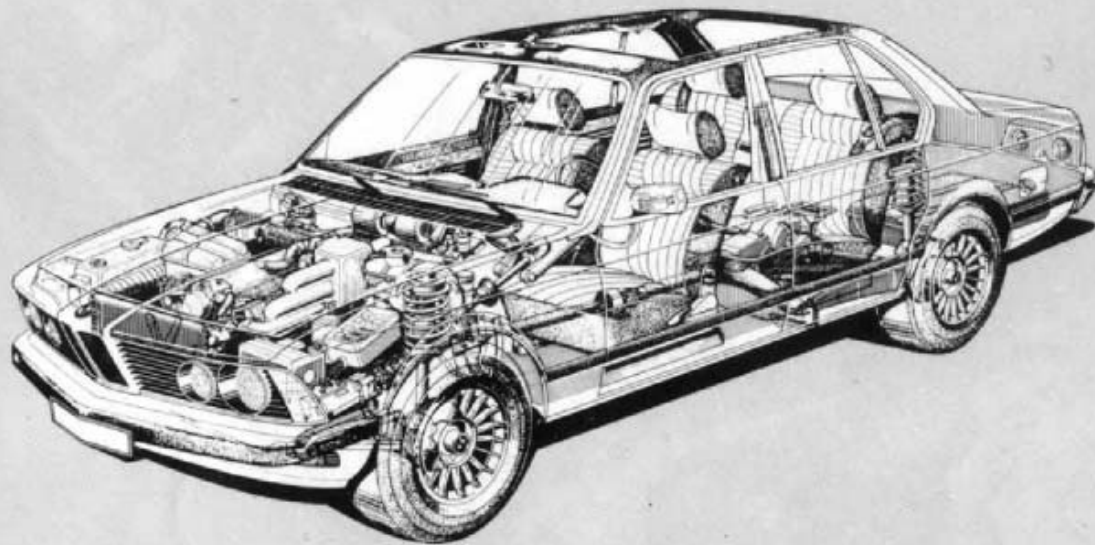

Engine  
Fuel consumption  
Power outputs  
Graphs  
Cooling  
Transmission  
Axles  
Steering  
Wheels and tyres  
Brakes  
Heating and ventilation  
Air-conditioning  
Electrical system  
Dimensions and weights  
Road performance  
Fuels and lubricants  
Oil grades for power  
steering and automatic  
transmission  
Technical descriptions

## Specifications

### ENGINE

#### Type

Four-stroke, in-line, water-cooled, with two overhead camshafts (DOHC).

#### Position

Over front axle, inclined, with three-point location: at front, close to centre of gravity, with rubber mountings attached direct to the front axle beam. Rear of engine flange-mounted to gearbox, with rubber mounting on gearbox crossmember.

#### Cylinder block

Special grey cast-iron.

#### Crankshaft

Forged steel, heat treated.

Each main bearing with two oil-feed ducts.

#### Connecting rods and pistons

Forged steel rods; replaceable three-layer bearings. Small-end bearing offset in piston

Engine – BMW 745i



28 81 01 602 00



### **Cylinder head**

Light alloy, with shrunk-in valve seat rings and valve guides.

### **Valves**

Overhead; inclined in inverted V arrangement

### **Lubrication**

Pressurised oil circuit with full-flow filter and pressure regulation valve in filtered oil circuit.

**Cylinder head – BMW 745i**

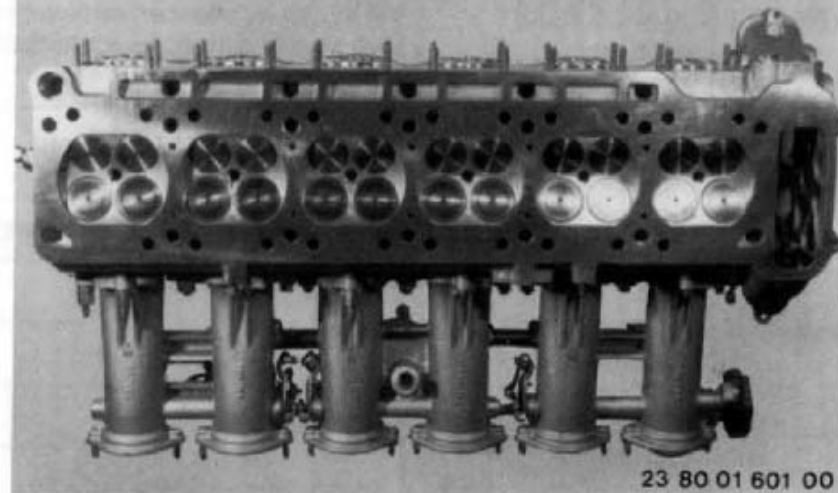

**Oil consumption**

Max. 0,4 litre per 100 km

**Oil filter**

Full-flow type, with paper element and pressure relief valve opening at  $2,5 \pm 0,2$  bar.

**Breathing**

Crankcase and valve chamber connected by cast-in passage and fumes led out to throttle stub pipe.

**Air cleaner**

Single air cleaner element in intake air silencer

**Intake airflow**

Via intake air silencer, airflow metre, throttle stub pipe and air collector to the inlet pipes with injectors.

**Fuel supply**

Electric fuel pump delivery rate 130 litres per hour.

System pressure  $3,0 \pm 0,2$  bar.

**Fuel filters**

Main fuel filter with throwaway element in feed line, mesh strainer in the fuel tank suction unit.

		<b>BMW 745i</b>
<b>Displacement – effective</b>		3453 cm <sup>3</sup>
<b>Number of cylinders</b>		6
<b>Max. output (DIN 70020)</b> at engine speed		210 kW (290 bhp) 6500/min
<b>Max. torque</b> at engine speed		347 Nm 4700/min
<b>Output per litre</b>		62 kW (84,2 bhp)
<b>Max. permissible engine speed</b>		7000/min
<b>Max. continuous engine speed</b>		7000 rpm
<b>Compression ratio</b>		10,5 : 1
<b>Stroke/bore</b>		84/93,4 mm
<b>Power/weight ratio</b> Car ready for road, tank full		10,38 kg/kW
<b>Fuel supply system</b>		Bosch Motronic
<b>Fuel consumption to DIN 70030/1 ECE standard</b>		
	<b>5-speed</b>	<b>Automatic</b>
– 90 km/h litres/100 km	8,9	10,4
– at 120 km/h litres/100 km	10	12,1
– during town driving litres/100 km	19,6	

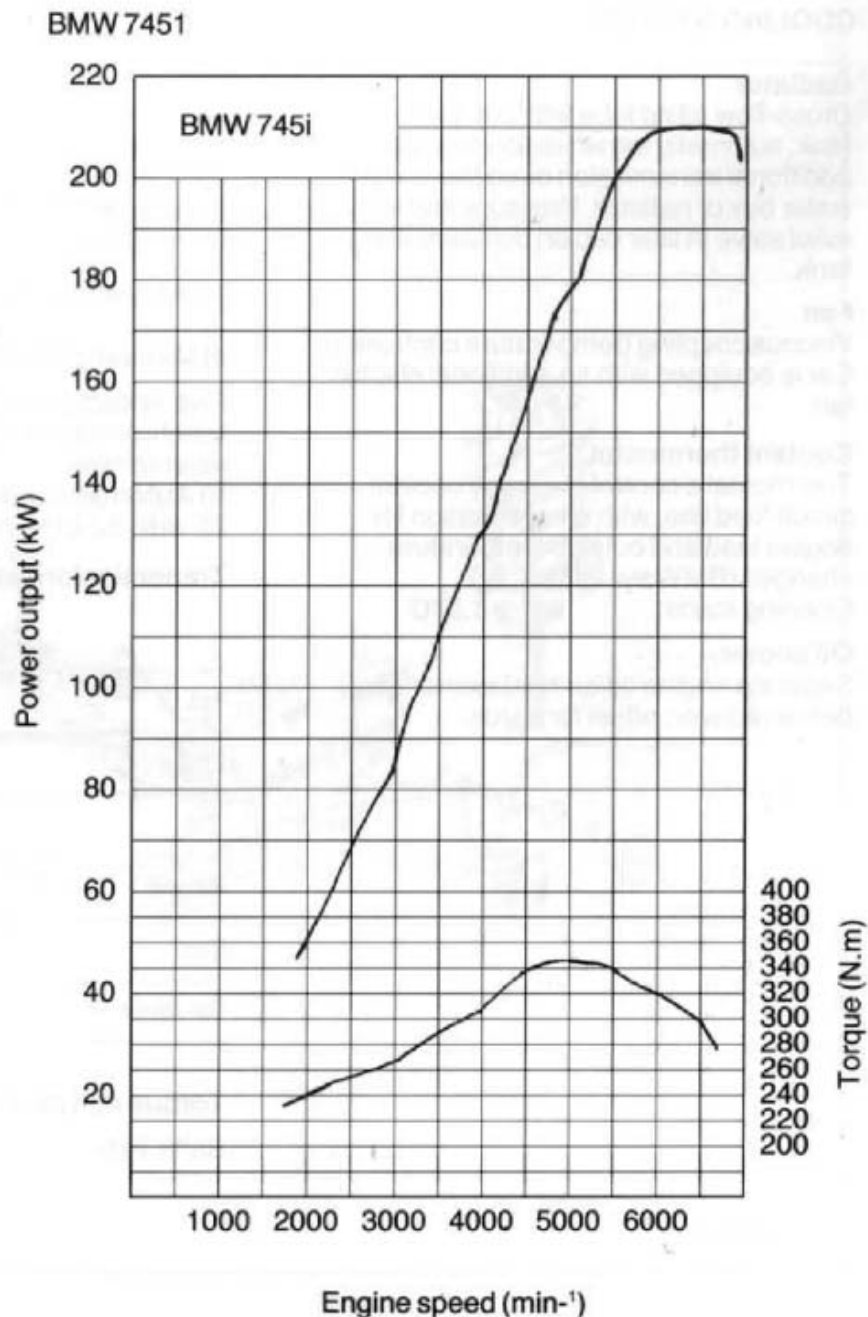

## COOLING SYSTEM

### Radiator

Cross-flow gilled tube with compensating tank; automatic transmission cars with additional transmission oil cooler in right water box of radiator. Pressure and vacuum relief valve in filler cap on compensating tank.

### Fan

Viscous coupling (temperature controlled). Car is equipped with an additional electric fan.

### Coolant thermostat

Thermostatic control of engine coolant circuit feed line, with compensation for engine load and outside temperature changes (BMW system).

Opening starts:  $80^{\circ} \pm 1,5^{\circ}\text{C}$

### Oil cooler –

Separate engine oil/air heat exchanger below radiator, offset forwards.

## CLUTCH

Hydraulically operated single dry plate diaphragm spring clutch with torsional vibration damper and automatic wear compensation (manual gearbox); fluid coupling with torque converter (automatic transmission).

## TRANSMISSION

### a) Manual gearbox

Five-speed gearbox with Borg-Warner synchromesh on all forward ratios and reverse ratio.

### b) Automatic transmission

ZF 4HP 22-EH with electro-hydraulic control

### Transmission ratios

	5-speed	Automatic
1st	3,72	2,48
2nd	2,40	1,48
3rd	1,77	1,00
4th	1,24	0,73
5th	1,00	–
Reverse	4,23	2,09

### Torque converter ratios

BMW 745i 1-2, 15:1 or 1-1, 88:1

## PROPELLER SHAFT

Two-section propeller shaft, centered at front with joint disc in guide journal, with universal joints at rear and at centre. Needle roller bearings, resilient centre bearing mount.

## FINAL DRIVE

Hypoid bevel, running in taper roller bearings. Tooth contact pattern: Klingelberg or Gleason.

### Final drive (rear axle) ratios

	Crown wheel and pinion
BMW 745i M	3,45 : 1
BMW 745i A	3,45 : 1

ZF disc type limited slip differential with approximately 25% locking action.

### Drive to rear wheel

Double universal-joint half-shafts at left and right, with maintenance-free homo-kinetic joints.



## SUSPENSION

### Front axle

Double-pivot, spring strut independent suspension with anti-dive control and roll angle stops.

Lower wishbones, trailing links and spring struts with double-acting telescopic hydraulic dampers; offset castor angle and lateral force equalization.

High-mounted coil springs off-centre in relation to strut axes, with rubber auxilliary springs. Total travel at wheel 198 mm.

Torsion-bar stabilizer (anti-roll bar) in maintenance-free rubber bushings.

**Toe-in\***  $0,5^{+0,1}_{-0,5}$  mm

– with TRX tyres  $0,6^{+1,0}_{-0,5}$  mm

equivalent to  $0^{\circ} 4,5^{+9'}_{-4,5'}$

**Camber angle\***  $0^{\circ} \pm 30'$

**Castor angle\***  $9^{\circ} \pm 30'$

**Kingpin inclination\***  $11^{\circ} 35' \pm 30'$

### Toe-out on turns

at 20° inside wheel lock  $1^{\circ} 40' \pm 30'$

### Max. wheel lock\*

Inner wheel  $43^{\circ}$

Outer wheel\*  $33^{\circ}$

Front axle

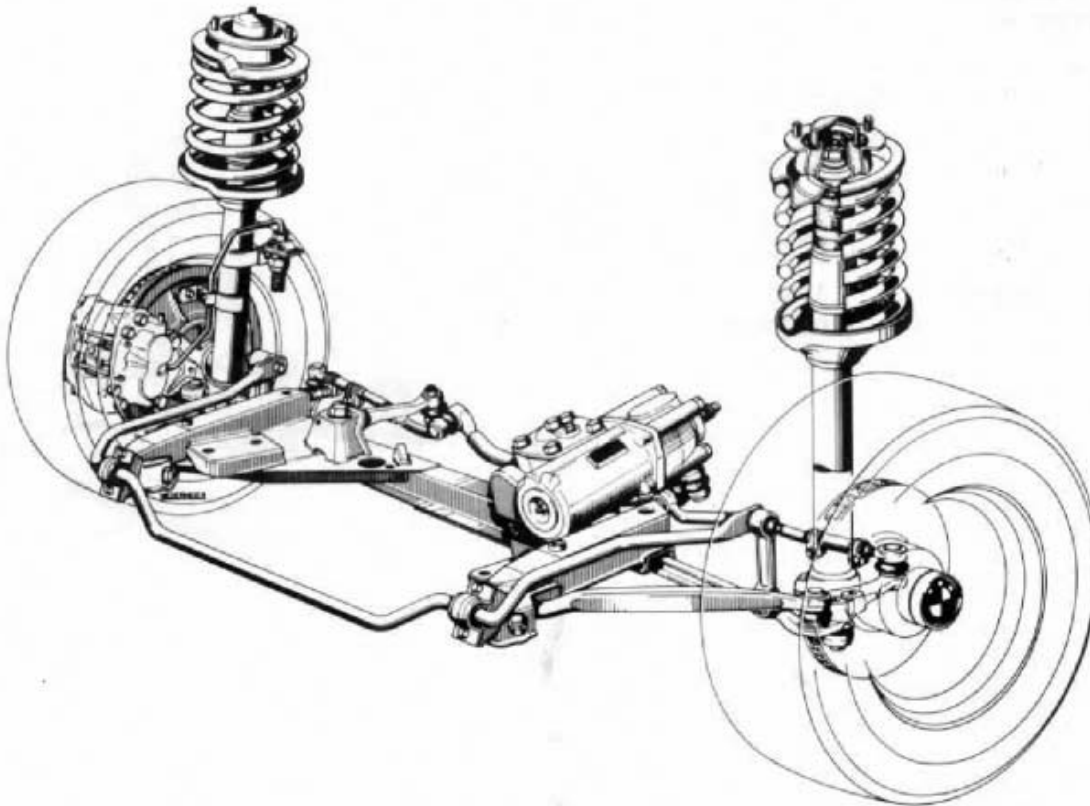

23 77 01 608 00

In normal load position: car with full tank and 2 x 68 kg on front seats, 1 x 68 kg on rear seats and 21 kg in luggage compartment.

## Rear suspension

Independent, with semi-trailing arms, maintenance-free rubber bushings and anti-dive control. Delta box-section member for trailing links and final drive bolted to bodyshell at three points through rubber mountings with longitudinal compliance.

Spring/damper struts with double-acting telescopic hydraulic dampers, coil springs and rubber auxiliary springs; total wheel travel 234 mm.

<b>Toe-in*</b>	$2 \pm 1$ mm
equivalent to	$0^{\circ} 20' \pm 10'$
<b>Camber angle*</b>	$1^{\circ} 30' \pm 30'$ negative

\* In normal load position: car with full tank and 2 x 68 kg on front seats, 1 x 68 kg on rear seats and 21 kg in luggage compartment.

## Rear suspension

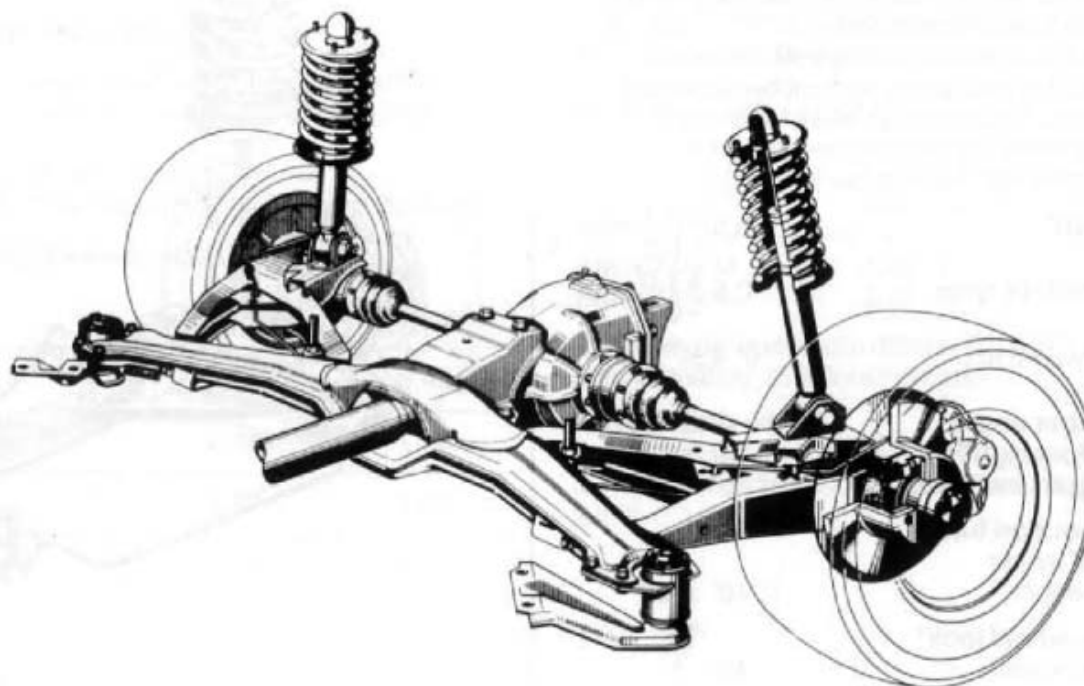

E 23 77 213

### Steering

ZF ball and nut power-assisted

**Ratio** 15,7 : 1

**Overall ratio:** 18,2 : 1

### Safety steering column

With two universal joints and resilient disc joint.

### Steering column reach adjustment

**Three-spoke steering wheel** 380 mm dia.

**Track rod:** three-section

### Wheels and tyres

**Important:** when renewing or removing tubeless tyres, always renew the rubber valve (43 GS/11,5 DIN 7780) at the same time as a safety precaution.

When fitting other than genuine BMW light-alloy wheels, it may be necessary to use the corresponding wheel bolts instead of genuine BMW wheel bolts.

Protect the valves with **screw-on dust caps** to avoid dirt entering. Dirt in the valves can cause a slow leak and endanger road safety.

You are recommended to use only **tyres approved by BMW** for your car. If a different make of tyre has to be fitted to cars capable of over 220 km/h top speed, obtain confirmation from the tyre supplier or manufacturer that the tyre can withstand the loads likely to be developed by this model when its full performance is utilized.

**The following BMW wheels (rims) and tyre sizes are factory-approved:**

Radial ply tyres  
(tubeless)

Light alloy  
wheels

---

**BMW 745i**

---

205/55 VR 16 (front)

7" x 16"

---

225/50 VR 16 (rear)

8" x 16"

---

**Optional**

220/55 VR 390

165 TR 390

---



### Diagonally-split dual circuit brake system

Hydraulic brakes with booster servo operated by hydraulic pressure supplied from hydraulic pump for steering and brake hydraulics. Transparent brake fluid reservoir with electrical level sensor for brake warning light.

#### Front brakes

Four-piston, fixed caliper disc brakes with automatic pad wear compensation; pad wear warning sensor in left caliper.

Ventilated discs.

#### Rear brakes

Single-piston wraparound caliper disc brakes with automatic pad wear compensation and pad wear warning sensor in right caliper.

#### Handbrake

Acting mechanically on rear wheels. Drums integrated into rear brake discs.

Manual wear compensation at brake shoe adjuster.

### Schematic of hydraulic diagonally-split dual circuit brake system

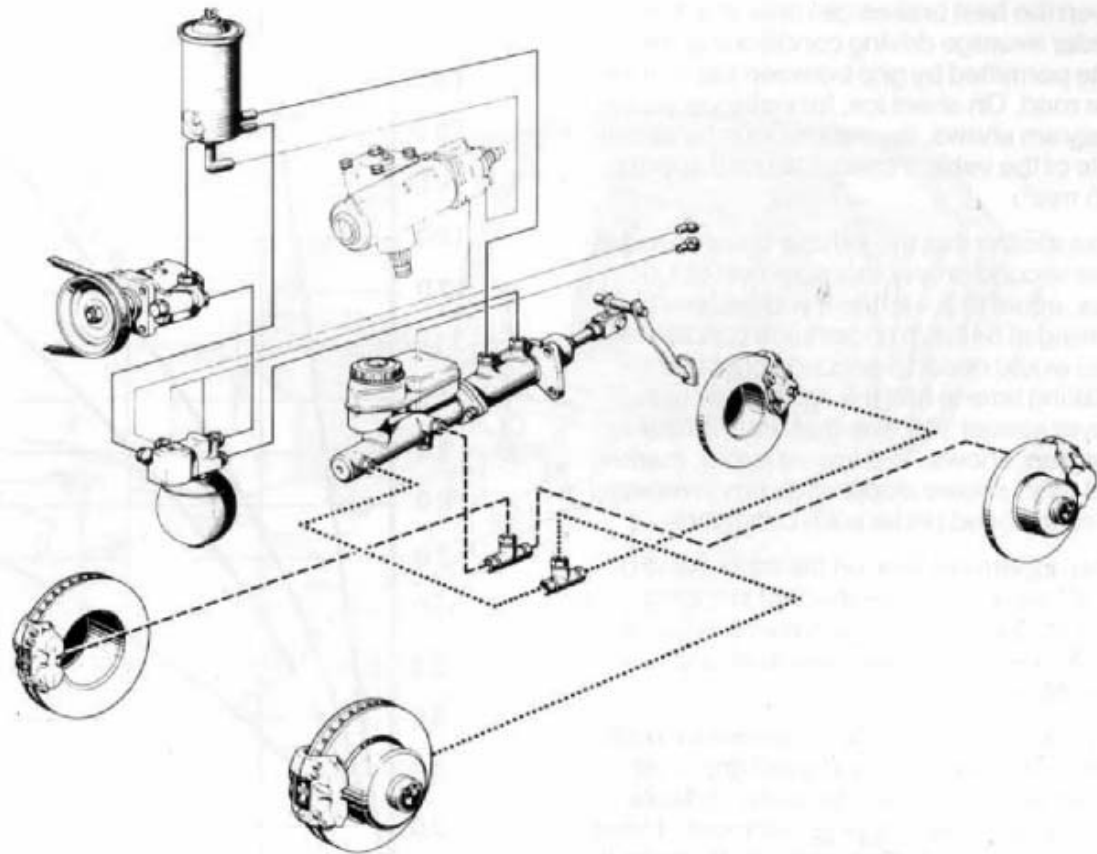

23 83 01 610 00

## Stopping distances

The total stopping distance is made up of reaction time (approx. 28 m covered in one second at 100 km/h) and the time taken for the brakes to respond and the actual distance needed to bring the car to a halt.

Even the best brakes can only stop the car under average driving conditions at the rate permitted by grip between the tyre and the road. On sheet ice, for instance, as the diagram shows, the maximum retardation rate of the vehicle cannot exceed approx.  $1,5 \text{ m/s}^2$ .

This means that the vehicle loses speed in one second only at this slow rate of  $1,5 \text{ m/s}$ , equal to  $5,4 \text{ km/h}$ . If you had been driving at  $54 \text{ km/h}$  under such conditions, you would need 10 seconds of actual braking time to halt the car, and would cover almost 100 m in that time, as the diagram shows. The lowest curve, marked  $1,5 \text{ m/s}^2$ , shows stopping distance referred to road speed under such conditions.

The uppermost line, on the other hand ( $8 \text{ m/s}^2$ ) represents the shortest stopping distance which can normally be achieved under the most favourable road grip conditions.

The centre line ( $4,5 \text{ m/s}^2$ ) applies to roads with a surface providing good grip, even when wet, and thus attempts to indicate typical average stopping distances. These values can be taken as a guide for normal driving on dry roads.

Stopping distances related to road speed and brake retardation

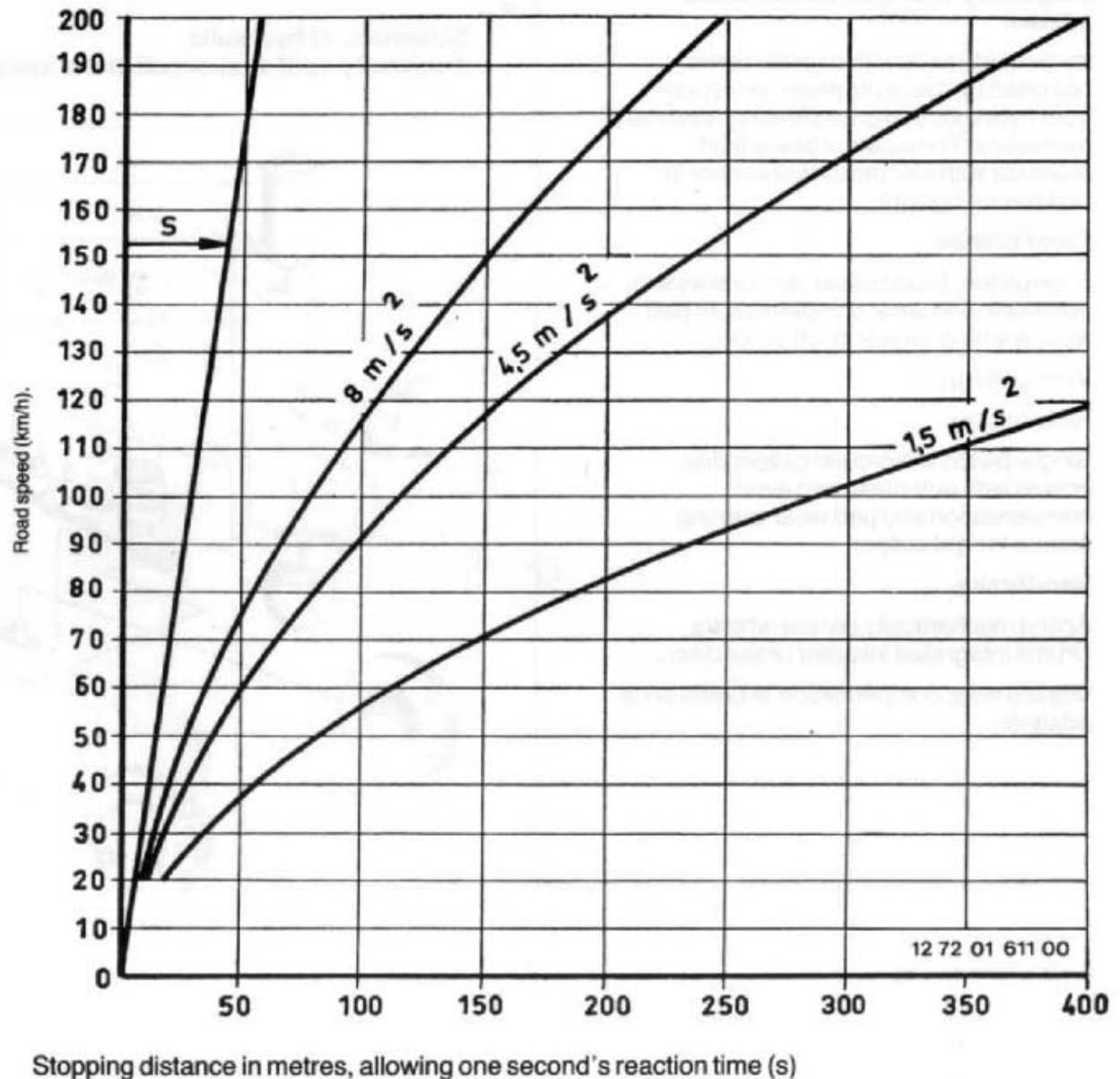

Note that the values may vary for better or worse according to the efficiency of your brakes, tyre condition and tread depth and the nature of the road surface.

The stopping distances all include a constant element "s" for the driver's initial reaction time.

### **BODY**

Self-supporting all-steel bodyshell welded to floor pan to yield an exceptionally torsionally rigid unit.

Safety passenger compartment with impact-absorbing front and rear body sections with controlled deformation behaviour.

Doors hinged at front; engine compartment lid hinged.

### **Windows**

Toughened safety glass all round laminated windshield, heated rear window.

**Luggage compartment** capacity app. 480 litres by VDA-approved method.

**Fuel tank** capacity 100 litres.

### **Safety passenger compartment**

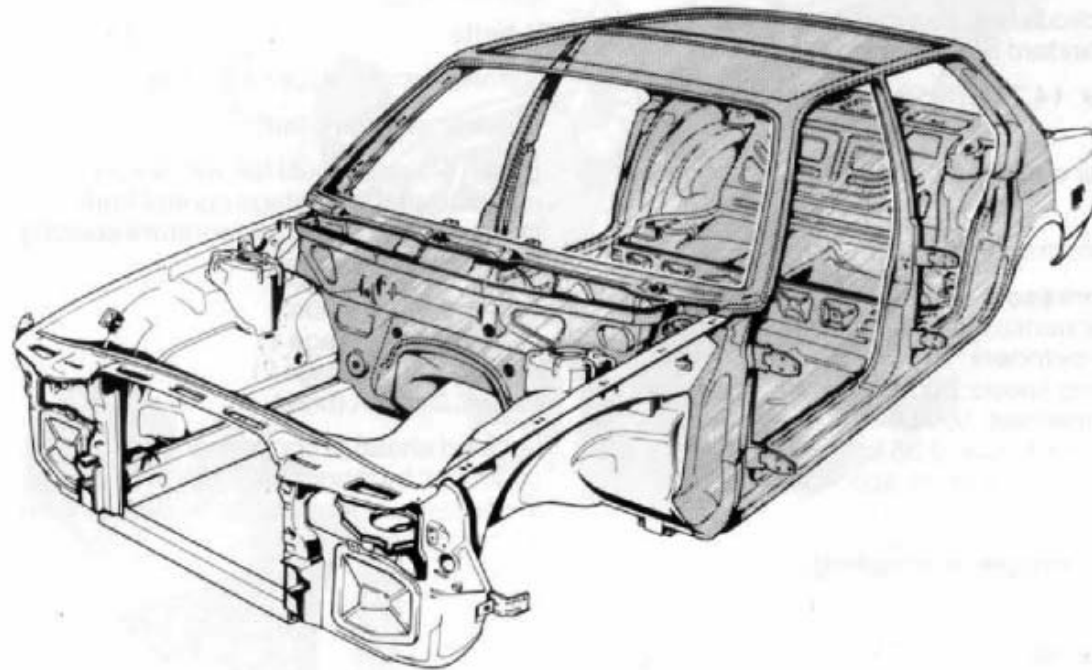

23 81 01 612 00

## Air-conditioning

### Evaporator

The air-conditioning evaporator is integrated into the fresh-air ventilation system. The air drawn in for cooling is supplied by the blower and cooled by the evaporator. The air is then delivered to the car's interior and distributed as in cars without air-conditioning.

Air recirculation: four-channel radial blower (on standard heater unit).

Airflow: 14,7 kg/min when using fresh air intake.

Min. air outlet temperature inside car: 5-6 °C.

Maximum cooling rate: 7,56 kW

### Compressor

Nippondenso type 10 P 15 E

No. of cylinders: 10

Running speed: 500-6000/min

Displacement: 150 cm<sup>3</sup>

Oil content: max. 0,35 kg

Power consumption: app. 4,4 kW (6 bhp) at max. running speed.

### Electromagnetic coupling.

127 mm diameter.

### Condenser

Surface area: 20,8 dm<sup>2</sup>

Block depth: 32 mm

### Dehumidifier

Steel vessel with inspection window  
Content: 0,54 dm<sup>3</sup>  
(with low pressure protection switch attached).

### Refrigerant

Grade: Frigen (CF<sub>2</sub>Cl<sub>2</sub>)  
(difluor-dichlormethane)  
Content 1300: ± 50

### V-belts

Narrow-section, 12,5 x 825 mm

### Electric auxiliary fan

Bosch 5-bladed axial fan with shroud, 365 mm diameter, two-stage control from magnetic clutch and temperature sensing switch in radiator.

Power consumption:  
100 W at 13 V (stage 1)  
300 W at 13 V (stage 2)  
Fuses: 2 x 25 A (blue)

Located ahead of condenser and controlled by magnetic clutch in response to coolant temperature, or by switching on air-conditioning.

### Safety precautions

The air-conditioning circuit must be filled only with a safe refrigerant ( Frigen 12). Although this substance is non-toxic and non-flammable at normal temperatures, and does not form an explosive mixture with air in any concentration, certain safety precautions are none the less essential. Note in particular following points:

**Avoid touching the liquid refrigerant, or frostbite symptoms will develop. Protect the eyes in particular by wearing goggles. If an accident occurs, obtain medical attention without delay.**

**Frigen is heavier than air, and so should not be drained off in an enclosed space. There is a risk of suffocation, particularly in inspection pits.**

**Never perform any welding work on a charged air-conditioning system or close to it, or pressure may build up on account of heat thus developed and lead to an explosion (the same precaution applies to any sealed vessel). Furthermore, Frigen decomposes at high temperature or when exposed to a flame, and the chemicals then produced constitute a health risk.**



### Programmed climate control

The electronic control system installed in your BMW can have its interior air supply air-conditioned fully automatically; the system is operated by **programmed control buttons**.

Electronic temperature control depends on the preselected program and the outside temperature, and is regulated by a **control unit** on the left of the panel.

Temperature changes are detected rapidly by the **temperature sensor** inside the car, behind the perforated panel. Radiated heat effects, particularly through the car's windows, are compensated for by an **outside temperature sensor** in the fan airstream. The average interior temperature selected for maximum occupant comfort is raised in winter by approximately 2 °C and lowered by a corresponding amount in summer.

The electropneumatic **air distribution flaps** and the **water valve** are actuated by the control unit, according to which push buttons are pressed.

**Blower speed** is varied automatically according to the temperature mixing flap setting, but can also be varied **steplessly** by hand. The blower has an electronic overload cutout.

### Air-conditioning

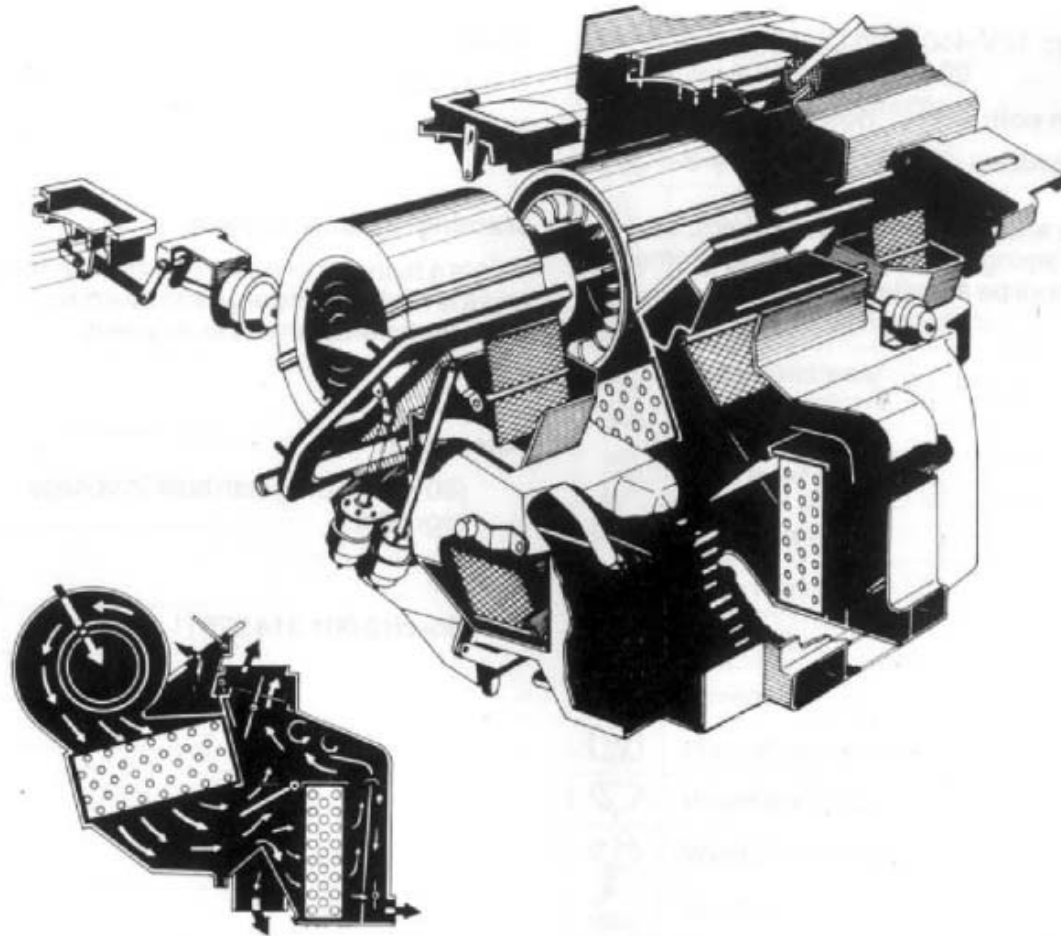

2377 01 614 00

## ELECTRICAL SYSTEM

**Battery:** 12V-450 Cold Cranking Amperes  
80 minutes reserve capacity.

**Ignition coil:** Bosch 0 221 122 032

**Firing order:** 1-5-3-6-2-4

On cars with digital motor electronics, the ignition timing is permanently programmed and cannot be adjusted.

### Spark plugs

Champion A-6G  
Electrode gap, 0,5 + 0,1 mm

### Warning: ignition system

This is a high-performance ignition system, and it is **highly dangerous** to touch any live components when the engine is running.

### Alternator

(80 A, 1 120 W) with built-in voltage regulator.

### Starter

Bosch 0 001 314 025 (1,5 kW)

### Headlights

**Highbeam:** two halogen units (inner), lens diameter 135 mm and two low-beam halogen units (outer) operating together.

**Low beam:** two asymmetric beam halogen units also containing the parking (side) lights; lens diameter 165 mm.

Dimensions and weights	BMW 745i	
Length	4 860 mm	
Width	1 800 mm	
Height (unladen)	1 430 mm	
Wheelbase	2 795 mm	
Ground clearance (laden)	132 mm	
Front overhang	905 mm	
Rear overhang	1 160 mm	
Front track (at max. permissible axle load)	1 508 mm	
Rear track at max. permissible axle load)	1 522 mm	
Min. turning circle (wheels)	10,6 m	
Min. turning circle (overall)	11,6 m	
Unladen weight (ready for road, tank full)	1 718 kg	
Permissible all-up weight	2 210 kg*	2 150 kg**
Permissible front axle load	1 060 kg	
Permissible rear axle load	1 150 kg	
<b>Permissible trailer loads</b>		
unbraked	650 kg	
braked, max. gradient 12%	1 600 kg	
braked, max. gradient 8%	2 000 kg	
Permissible trailer nose weight	65 kg	
<b>Permissible roof load</b> (when fully laden, the axle load limits must not be exceeded)	100 kg	

\* At speeds up to 220 km/h

\*\* At speeds above 220 km/h

## International symbols

	Battery charge
	Engine oil pressure
	Coolant temperature
	Hazard warning flashers
	Brake system
	Antilock braking system
	Brake pad wear
	Turn indicators
	Fuel level
	High beam
	Rear fog light
	Fog lights
	Blower
	Heated rear window
	Windshield wipers
	Windshield wipers/washer
	Lighter
	Air-conditioning
	Handbrake
	Side/Parking lights
	Windshield defrosting
	Headlight beam adjuster.

# Body dimensions (in millimetres)

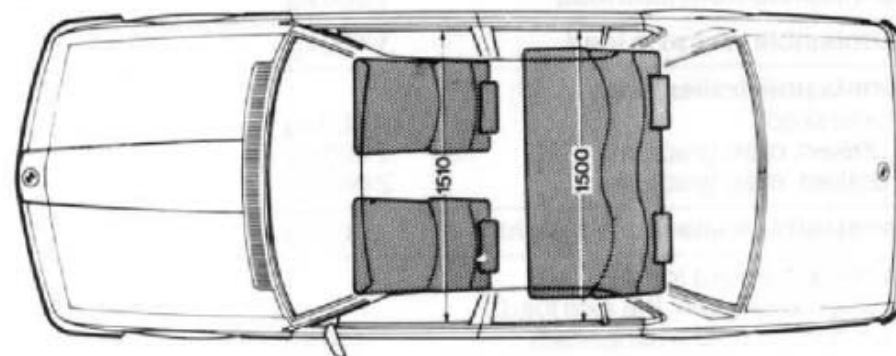
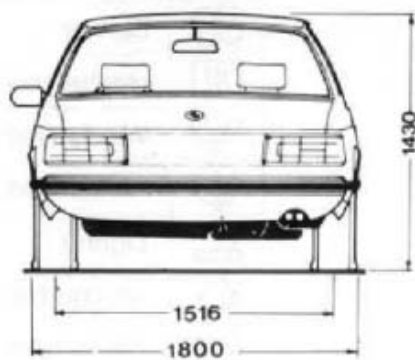
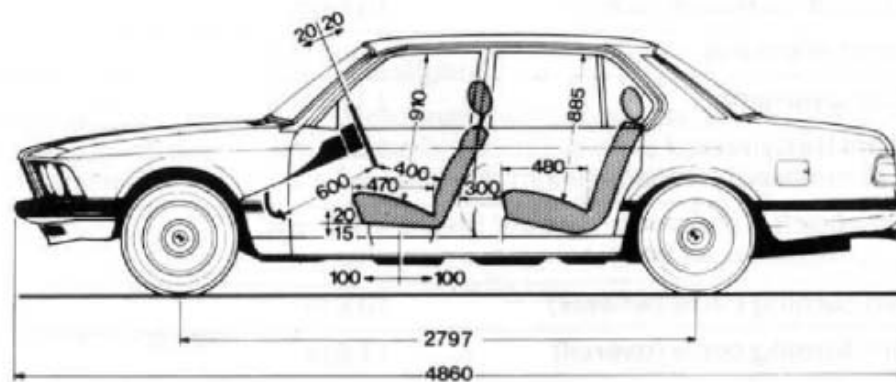
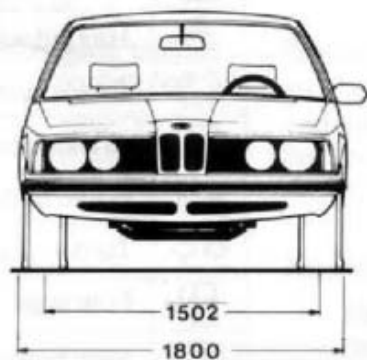

23 83 01 615 00



## Performance data (at sea level)

---

### Top speed

Manual gearbox	241 km/h at 7 000 r/min in 5th gear.
Automatic transmission	234 km/h at 6 950 r/min with program switch on 'S' position.
Automatic transmission	216 km/h at 4 630 r/min in 4th gear.

---

### Max. gradients

in 1st gear                      60% (1 in 1,67)

---

### Acceleration km/h

	Automatic transmission	Manual gearbox
0-50	3,8 sec	2,4 sec
0-80	6,4 sec	4,8 sec
0-100	9,1 sec	7,0 sec
0-120	12,1 sec	9,5 sec
0-140	15,3 sec	13,0 sec

---

## Service instruction chart

		Running-in Inspection	Engine Oil Service	Inspection I	Inspection II
<b>Engine</b>	Check oil level regularly Change oil Brand-name HD oil for spark-ignition engines (see page 4-11)	X	X	X	X
<b>Engine oil filter</b>	Change filter	X	X	X	X
<b>Hydraulic power steering</b>	Check oil level regularly For oil grades, see page 6-29	X		X	X
<b>Manual gearbox</b>	Check oil level Change oil Brand-name SAE 80 gear oil Specification MIL-L-2105 A or API-GL 4; alternatively single-grade HD engine oil (mineral oil based), SAE 20/30/40, specification API-SE or SF	X		X	X
<b>Automatic transmission</b>	Check oil level regularly Change oil For oil grades, see page 6-28	X		X	X
<b>Rear axle (final drive)</b>	Check oil level Change oil, replace oil sieve Brand-name running-in hypoid gear oil, SAE 90 (your BMW dealer knows the approved oil grades)	X		X	X
<b>Throttle butterfly lever and gate</b>	Grease Multi-purpose grease			X	X
<b>Front and rear lid catches, door lock latches and strikers</b>	Grease Multi-purpose grease			X	X

		Running-in Inspection	Engine Oil Service	Inspection I	Inspection II
<b>Fuel tank</b>					
<b>Radiator</b>	Check coolant level regularly Use only long-term antifreeze with corrosion inhibitor – your BMW dealer knows the factory-approved grades			X	X Renew contents every two years
<b>Brakes</b>	Check fluid level regularly Your BMW service station knows the factory-approved grades	X		X	X Contents must be renewed every year
<b>Battery</b>	Check terminals			X	X
<b>Windshield washer</b>	Check liquid level regularly. Antifreeze: to DIN 51 421 standard	X		X	X
<b>Fuel system</b>					
Main fuel filter	Renew			X	X
<b>Intake air cleaner element</b>	Renew			X	X

**Lifting points for car hoists with four pick-up arms:**

Outer extremity of body, under the seam directly adjacent to the reinforced points used for the car's own jack.

**Warning:** If the car is jacked up directly beneath the front axle beam or the final drive, use suitable hoisting equipment or place a suitable piece of material between the jack pad and the housing to prevent damage to the final drive.

# Approved fluids for automatic transmission

## Initial filling and refilling of new and exchange units, topping up

Agip Dexron II	Agip, München	D-21 103	Kompressol-Fluid-Matic D 52	Kompressol, Köln	D-20 739
Antar Dexron II	Antar, Paris/F	D-20 600	Lastona Fluid II	Texaco, Hamburg	D-20 112
Aral Getriebeöl ATF 22	Aral, Bochum	D-20 749	Mac Dexron II	Shell Handel, Hamburg	D-20 137
Aseol Dexron II	Aseol, Bern/CH	D-16 712	MHG-Getriebeöl Dexron	MHG, Amberg	D-20 383
Aseol Dexron II	Aseol, Bern/CH	D-20 137	Mihag ATF Dexron	Mihag, Düsseldorf	D-20 739
Autol Dexron	Autol, Hannover	D-20 383	Mobil ATF 220	Mobil, Hamburg	D-20 104
Automatic Transmission Fluid Dexron	Haberland, Dollbergen	D-20 112	Motorex ATF Dexron II	Bucher, Langenthal/CH	D-21 121
Avia Fluid ATF 77 Dexron	Avia, München	D-20 760	Motul Dexron II	Motul, Aubervilliers/F	D-21 159
Aviaticon ATF Dexron	Finke, Bremen	D-20 112	ÖMV-Austromatic Dexron II	ÖMV, Wien/A	D-20 768
BayWa ATF Dexron	BayWa, München	D-20 739	OK ATF Dexron	ICPA, Dordrecht/NL	D-20 790
Beverol Dexron II	Beverol, Beverwijk/NL	D-20 727	OK Getriebeöl ATF Dexron	WCG, Münster	D-20 739
BP Autran DX II	BP, Hamburg	D-20 335	Opalfuid TA	Opal, Nanterre/F	D-20 728
Castrol TQ Dexron II	Castrol, Swindon/GB	D-20 180	Orvematic	Orvema, Maarsse/NL	D-20 725
Castrol TQ Dexron II	Castrol, Swindon/GB	D-20 691	Pamatic Fluid Dexron II	PAM, Aschaffenburg	D-20 739
Castrol TQ Dexron II	Castrol, Swindon/GB	D-20 366	Pennasol Fluid Getriebeöl Dexron	Pennasol, Lehrte	D-20 112
Castrol TQ Dexron II	Castrol, Swindon/GB	D-20 354	Pennzoil Hydra-Flo	Pennzoil, Houston/USA	D-20 122
Castrol TQ Dexron II	Castrol, Swindon/GB	D-20 182	PN-Fluid-Getriebeöl Dexron II	Neuling, Berlin	D-20 137
Castrol TQ Dexron II	Castrol, Swindon/GB	D-20 185	Polalfuid Dexron	Polaroil, Issoudon/F	D-20 356
Castrol TQ Dexron II	Castrol, Swindon/GB	D-20 583	Renofluid Dexron	Fuchs, Mannheim	D-20 739
Chevron Automatic Transmission Fluid	Chevron, Frankfurt	D-20 824	Selectol Fluid Getriebeöl Dexron	Käppler, Stuttgart	D-20 112
Dexron II	Deluxol, Rotterdam/NL	D-20 726	Shell Dexron II	Shell, Hamburg	D-20 137
Dexron II	Deutzer Öl KG, Köln	D-20 137	Sunmatic 149	Sun Oil, Antwerpen/B	D-20 101
Dexron II	Golden Fleece, Melbourne/AUS	D-20 352	SVG Getriebefluid ATF	HGK, Düsseldorf	D-20 790
Dexron II	Labo, Nanterre/F	D-20 923	Texaco Texamatic Fluid 9226	Texaco, Hamburg	D-20 112
Duckhams Fleetmatic C	Duckham, West-Wickham/Gb	D-20 801	Texamatic Fluid Dexron II	Caltex, London/GB	D-20 139
Elan Austromatic Dexron II	Elan, Wien/A	D-20 158	Texamatic Fluid Dexron II	Caltex, London/GB	D-20 329
Elfmatic G 2	Elf, Paris/F	D-20 211	Texamatic Fluid Dexron II	Caltex, London/GB	D-20 576
Ellmo Fluid Dexron	Eller-Montan, Duisburg	D-20 112	Total Dexron	Total, Paris/F	D-20 356
Esa Dexron ATF	Esa, Burgdorf/CH	D-20 356	Trek Dexron II	Trek, Johannesburg/ZA	D-20 530
Esso Automatic Transmission Fluid Dexron	Esso, Hamburg	D-21 065	Turbo-Getriebeöl ATF Dexron	Bösche & Bödeker, Bremen	D-20 383
Fanal ATF Dexron II	Fanal, Mülheim	D-20 383	Tuteia GI/A	Fiat, Torino/I	D-20 782
Fina Dexron II	Fina, Frankfurt	D-20 668	Valvoline Valvomatic ATF Type Dexron II	Valvoline, Hamburg	D-20 739
Frontol Getriebeöl DXS Dexron C	Schindler, Hamburg	D-20 383	Veedol ATF Dexron II	Veedol Internat./GB	D-20 816
Gulf ATF Dexron II	Gulf, Rotterdam/NL	D-20 111	Veedol ATF Dexron II	Veedol Internat./GB	D-20 366
Giromatic Dexron C	Martin, Nürnberg	D-20 780	Veedol ATF Dexron II	Veedol Internat./GB	D-20 808
Homberg Getriebe Fluid	Homberg, Wuppertal	D-20 739	Westfalen-Getriebeöl ATF Dexron	Sauerstoffwerk, Münster	D-20 739
Hansa Dexron	Öl Hansa, Hamburg	D-20 739	Wewag Automatic Getriebeöl ATF Dexron	Wewag, Bocholt	D-20 739
HG Renofluid Dexron	Raiffeisen, Hannover	D-20 739	Wiesolub ATF Dexron	Mihag-Wiesöl, Düsseldorf	D-20 739
Hafa Transmatic B II	Sofra, Paris/F	D-20 781	Yacco ATF Type II	Yacco, Caudebec les Elbeuf/F	D-20 806

## Approved oil grades for power steering

### Initial filling, refilling, topping up

Avia Fluid ATF 77 Dexron	Avia Mineralöl, München
BP Autran DX II	BP, Hamburg
Caltex Texamatic Fluid Dexron II	Caltex, Ltd., London/GB
Castrol TQ Dexron II	Castrol, Swindon/GB
Esso ATF Dexron	Esso AG, Hamburg
Frontol Getriebeöl DXS Dexron C/D	Ölwerke Schindler, Hamburg
Shell ATF Dexron II	Deutsche Shell AG, Hamburg
Texamatic Fluid 9226	Deutsche Texaco, Hamburg
Veedol ATF Dexron II	Veedol GmbH, Hamburg

### Topping up only:

D-20 760	AERO-Line Dexron	Prinz Schulte, Köln-Frechen	D-20 101
D-20 335	Antar Dexron II	Antar SA et C, Paris/F	D-20 600
D-20 139	Aral Getriebeöl ATF 22	Aral, Bochum	D-20 749
D-20 815	Autol Getriebeöl Dexron	Autol-Werke, Hannover	D-20 383
D-20 277	BayWa ATF Dexron	BayWa, München	D-20 739
D-20 383	Beverol Dexron II	Beverol, Beverwijk/NL	D-20 727
D-20 137	BP Autran G 3 P 770 810	BP, Hamburg	
D-20 112	Castrol TQ Dexron II	Castrol, Swindon/GB	D-20 180
D-20 816	Chevron Automatic Transmission Fluid	Chevron, Frankfurt	D-20 824
	Deluxol Transmatic Fluid Dexron II	Deluxol, Rotterdam/NL	D-20 726
	Deutz Oel Dexron II	Deutzer Oel GmbH, Köln	D-20 137
	Duckhams ATF Dexron	Duckham, London/GB	D-20 801
	Elan Austromatic Dexron II	Elan, Wien/A	D-20 768
	Elfmatic G 2	Elf, Paris/F	D-20 211
	ESA ATF Dexron	ESA, Burgdorf/CH	D-20 739
	GI/A Dexron II	Fiat, Turin/I	D-20 782
	Giromatic Dexron C	Martin, Nürnberg	D-20 383
	Golden Fleece Dexron II	Golden Fleece, Melbourne/AUS	D-20 352
	Gulf ATF Dexron II	Gulf, Rotterdam/NL	D-20 111
	Hafa Transmatic B-D II	Sofra, Paris/F	D-20 781
	Hans Dexron	Öl Hansa, Hamburg	D-20 739
	Homberg Getriebe Fluid	Homberg, Wuppertal	D-20 739
	Kompressol Fluid Matic D52	Kompressol, Köln	D-20 739
	Mihag ATF Dexron	Mihag, Düsseldorf	D-20 739
	Mobil ATF 220	Mobil Oil AG, Hamburg	D-20 104
	Mobil ATF 210 2P 721 005	Mobil Oil AG, Hamburg	
	Orvematic	Orvema, Maarssen/NL	D-20 725
	ÖMV Automatic Dexron II	ÖMV, Wien/A	D-768
	Renofluid Dexron	Fuchs, Mannheim	D-20 739
	Shell Donax TF 3 P 731 113	Deutsche Shell AG, Hamburg	
	Sunamatic 149	Sun Oil Company, Antwerpen/B	D-20 101
	Teboil Automatic Fluid	Oy Teboil, Helsinki/SF	D-20 111
	Total Dexron	Total, Düsseldorf	D-20 356
	Trek Dexron II	Trek, Johannesburg/ZA	D-20 530
	Turbo Getriebeöl ATF, Dexron	Bösche & Bödeker, Bremen	D-20 383
	Unil Matic Dexron II	Unil Beauvais/F	D-20 740
	Valvoline Valomatic Type Dexron II	Valvoline, Hamburg	D-20 739
	Veedol ATF Dexron II	Veedol, England	D-20 808
	Veedol ATF Dexron R II	Veedol, England	D-20 366
	Westfalen Getriebeflüssigkeit ATF Dexron	Sauerstoffwerk Westfalen, Münster	D-20 739
	Wiesolub ATF Dexron	Wiesöl, Wiesbaden	D-20 739



# Technical descriptions

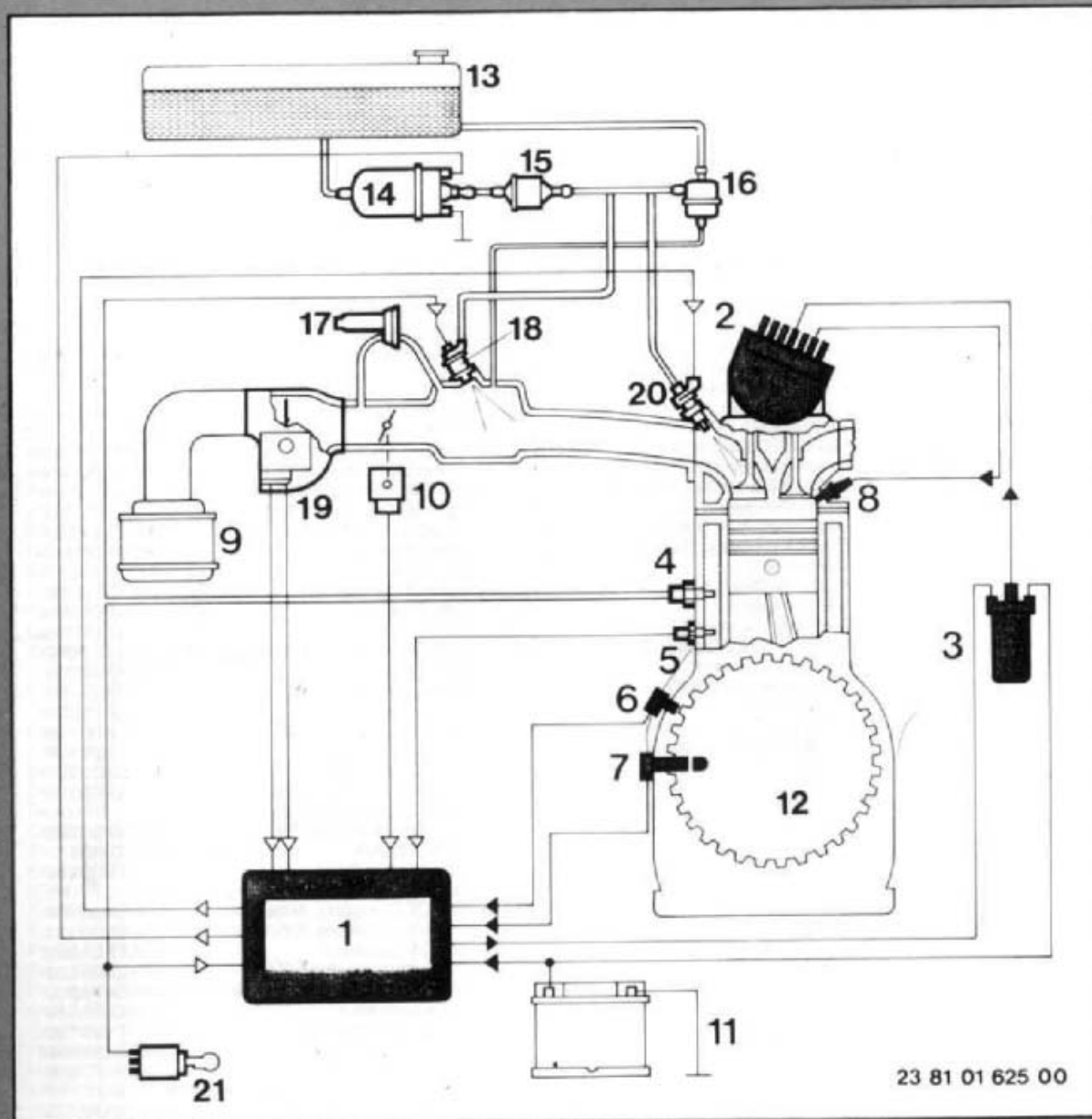

- Fuel injection system
- Automatic transmission
- Power steering
- Limited-slip differential
- Self-leveling suspension
- Digital motor electronics
- Antilock braking system
- Air-conditioning

## Fuel injection system

The system on BMW measures the volume of air drawn in by the engine. The intake airflow passes through the air cleaner and the **airflow meter** and thence to the **throttle stub pipes** and **intake air distributor**, from which an inlet pipe leads to each cylinder.

Each cylinder has its own electro-magnetically operated **injector** located in front of the inlet valve in a position designed to ensure good performance and response as well as minimum exhaust emissions.

An **additional air slide valve** bypasses the throttle butterfly stub pipe and controls the additional air volume needed for smooth running when the engine is still cold. On the warm engine, idle airflow control is by means of a bypass round the throttle butterfly.

### 1. Fuel supply

An **electric roller cell pump** draws fuel from the tank and builds up the injection pressure. A **filter** is incorporated into the feed line.

The **pressure regulator** is connected to the intake air distributor by a hose. This ensures that the pressure differential between fuel and intake pressures remains constant and the volume of fuel delivered by the injectors is related only to their opening period.

### 2. Control of fuel volume

The volume of air drawn into the engine is measured by the airflow meter and converted to an electrical impulse of a given voltage by a potentiometer. This impulse is transmitted to the **control unit**, which divides the voltage by the running speed to determine the quantity of fuel needed. The input signal for the running speed is the

elapsed time between two successive firing pulses. All the injectors are wired in parallel electricity, and thus open simultaneously but at different moments in the combustion cycle at the various cylinders. To aid smooth combustion, half of the total volume of fuel computed as being necessary for the engine's working cycle is injected per half rotation of the camshaft (corresponding to each complete rotation of the crankshaft).

### 3. Automatic cold-start and warming up devices

During a cold start and the subsequent warm-up phase, the engine will need additional fuel. If engine temperature is below a predetermined value, the **cold-start valve** injects additional fuel for as long as the starter motor is running and the **heat-sensitive time switch** is closed. Above this value the heat-sensitive time switch interrupts the power supply to the starting valve, which cannot then deliver extra fuel during starting.

During the warm-up phase a **temperature sensor** in the coolant control mixture enrichment via the control unit. As engine temperature rises the additional volume of fuel is steadily reduced, and ceases entirely when the engine's normal operating temperature is reached.

Apart from additional fuel, the engine needs a larger volume of air when starting and while warming up. the **additional air slide valve** bypasses the throttle butterfly. When the engine is at normal operating temperature, the valve is fully closed. Correction for idle speed and full load is applied by two contacts in the **throttle butterfly switch**. At full load, the injectors remain open for the maximum period; on the overrun, however, the fuel supply is shut off

completely unless the accelerator pedal is depressed.

### 4. The electronic control unit

This unit has the task of supplying a command impulse to the electromagnetic injectors and opening them for a precisely defined period. It processes information from the various sensors which convert the engine's operating values into electrical signals.

### 5. The airflow meter

This supplies a signal to the control unit at a voltage which depends on the airflow through the meter. A rectangular baffle plate in an air passage of the same shape is forced back to a given angle against a spiral spring by the incoming airflow. The baffle plate shaft operates a potentiometer, which converts angular movement of the baffle plate into a signal at an equivalent voltage and transmits it to the control unit. The output signal voltage is inversely proportional to the incoming airflow.

The airflow meter also houses an intake air temperature sensor.

### ZF 4 HP 22 EH automatic transmission

- 1 – Connection to driving plate
- 2 – Converter lockup clutch
- 3 – Torque converter
- 4 – Oil pump
- 5 – Multi-plate clutches
- 6 – Epicyclic gear sets
- 7 – Pulse wheel for speed sensor
- 8 – Parking lock gearwheel
- 9 – Transmission breather
- 10 – Throttle-operated cable
- 11 – Selector lever shaft
- 12 – Oil pan with control unit
- 13 – Connection to electronic control unit
- 14 – Output flange

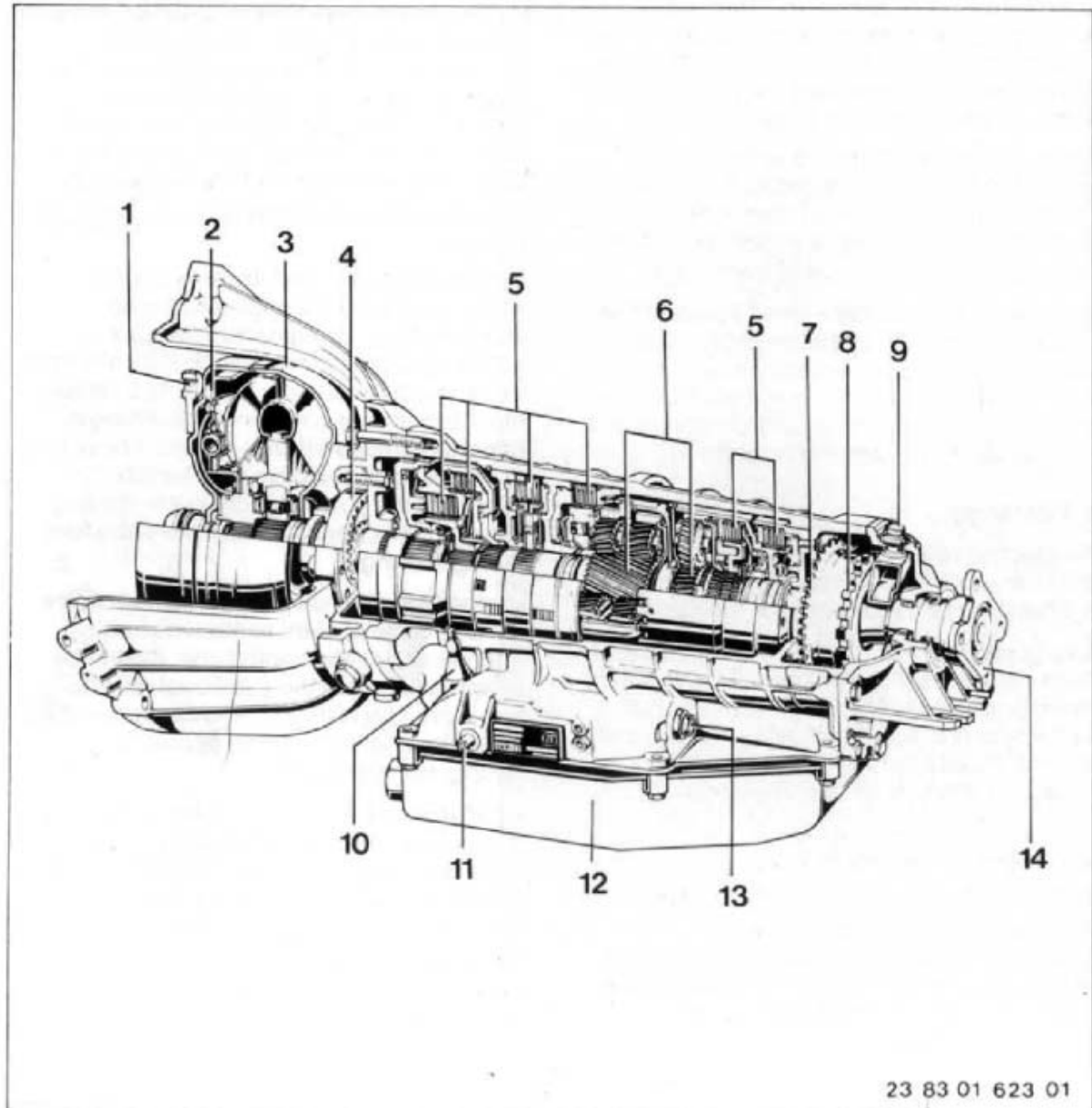

23 83 01 623 01

### Automatic transmission

The ZF automatic transmission consists of a 4-speed epicyclic gearbox preceded by a torque converter. The **torque converter** provides the necessary torque multiplication when starting: beyond this torque multiplication speed, when engine and transmission speeds are approximately the same, it acts as a fluid coupling, and transmits the drive to the gearbox input shaft with little or no increase in torque. In 4th gear a **converter lockup clutch** engages automatically above a transmission oil temperature of 20 °C and at a road speed of approx. 85 km/h (depending on accelerator pedal position) to provide a rigid mechanical link between engine and transmission.

The **epicyclic gearbox** which follows the converter has a reverse gear and four forward gears. The gears are selected by hydraulically actuated **multi-plate clutches** and freewheels. These are resistant to wear and do not have to be adjusted.

Above about 8 km/h, a **reverse gear selection interlock** prevents the driver from accidentally selecting reverse.

The three freewheels installed in the transmission enable power shifts to take place, that is to say there is no interruption of the flow of power to the wheels as a gear shift is made. A low-loss **oil pump** is mounted in the front end cover of the transmission. It supplies oil to the converter, the control unit and the lubricating circuit. The gearbox output shaft carries the parking lock gearwheel, with which a pawl engages when "P" is selected, to prevent the vehicle from rolling away.

The **control unit** with selector valve, control pistons and pressure valves is accommodated in the base of the transmission housing. Gear shift points are dependent of a combination of road speed and accelerator pedal position. A **centrifugal governor** on the output shaft supplies impulses to indicate road speed.

Gears are changed automatically at preset points depending on the speed range selected at the lever.

If sudden acceleration and maximum engine power are required, the accelerator pedal can be pressed down fully beyond the normal full-throttle detent. When this "kick-down" facility is used, provided that the car is travelling below the maximum speed permitted for the lower gear, the transmission will shift at once to a lower gear and will not change up again until a much higher than usual speed has been reached, or the accelerator is eased back again. If in 4th gear, the transmission always kicks down to 3rd gear instantly.

### ZF 4 HP 22 EH automatic transmission

On the electronic-hydraulic transmission, impulses corresponding with speed are obtained from a pulse wheel and speed sensor.

Operating-condition values measured at the engine and the transmission (see digital motor electronics) are supplied as input signals to the common control unit. This not only computes the ignition timing angle and duration of fuel injection for the engine, but also the shift points for the automatic transmission.

With the aid of the **program switch**, the most suitable of three programs stored in the control unit can be selected manually at any time.

A **safety circuit** ensures that the vehicle can still be driven in 3rd gear or reverse if the electronics should fail. A **shift-down interlock** prevents the driver from shifting down into 2nd gear at high speed if the electronics should fail to operate correctly.



### Selector lever position D – 1st gear

Clutches 4 and 11 are engaged. The front planet wheel carrier of gear set 9 bears against freewheel 15 when the engine is pulling, but revolves freely on the overrun. Planetary gear set 10 rotates as a solid block with it. In selector lever position 1, clutch 8 is also engaged to provide engine braking.

### Selector lever position D – 2nd gear

Clutches 4, 6, 7 and 11 are engaged. Freewheel 15 is overrun. The hollow shaft with the sun wheel of planetary gear set 9 remains stationary. Planetary gear set 10 revolves as a solid block.

### Selector lever position D, 3rd gear

Clutches 4, 5, 7 and 11 are engaged. Freewheels 15 and 16 are overrun. Planet wheel sets 9 and 10 rotate as a complete unit, with ratio 1 : 1.

### Selector lever position D, 4th gear

Clutches 4, 5, 7 and 12 engaged. Freewheels 14, 15 and 16 are overrun. Planet wheels set 9 rotate as a complete unit. The hollow shaft with sun wheel of planet wheel set 10 is stationary. Torque converter 3 is bypassed above a certain road speed by converter lock-up clutch 2.

### Selector lever position R (Reverse)

Clutches 5, 8 and 11 are engaged. Since the front planet wheel carrier or gear train 9 is prevented from turning, the output shaft is driven in the opposite direction.

Planet wheels set 10 rotate as well, as a complete unit.

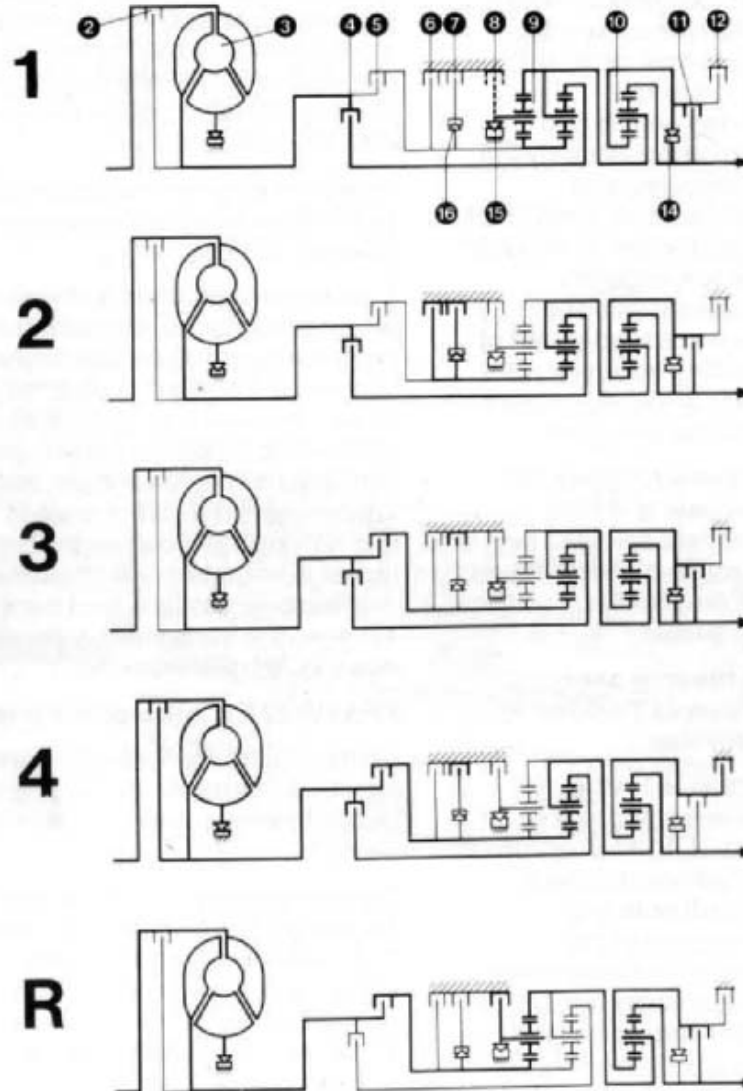

23 83 01 623 02



### Power steering

Today's traffic often calls for vehicles to be positioned accurately in lanes or parked in confined spaces, particularly in our city centers. The driver has to turn the steering wheel almost from one full-lock position to the other, often two or three times in succession, at very slow speeds.

Furthermore, sudden hazards can occur on the roads which demand an immediate change of direction at high speed in order to avoid a collision. If one front wheel should then stray on to a soft shoulder, high lateral forces will suddenly confront the driver.

With power steering, the driver in both cases senses only the need for very slight extra effort, since the force he exerts at the steering wheel rim is automatically boosted by the hydraulic power assistance.

The hydraulic power support is effective independent of speed i.e. at high speeds and when the steering force is low, the power assistance goes down, so that the driver feels he has more control and better road grip. When more steering effort is needed at a high speed, the full power assistance then becomes available.

Power assistance thus not only makes driving effortless but also makes a major contribution towards road safety.

If this BMW is your first car equipped with power steering, please remember that it takes a little time to grow accustomed to the light action of the steering under normal driving conditions.

### Construction

The ZF ball and neet power steering housing contains control valves, actuating rams and also a complete mechanical steering gear assembly. Oil pressure for the power assistance is supplied by a ZF vane-type high pressure pump driven by V-belt from the engine. The oil reservoir and oil filter are attached to the pump.

The design of the steering gear means that in the event of a hydraulic failure, or when the car's engine cannot be run and the car has to be towed away, full manual control is provided, although the steering then naturally calls for considerably more effort at the wheel rim.

Check oil level in the power steering reservoir during **inspections** (see **Section 4**). Only the oils listed on page 6-29 must be used for initial filling or refilling the power steering circuit, and for topping up the level (max. ¼litre) as the case may be.

All other attention which the power steering system requires should always be entrusted to a BMW service station.

### Disc-type limited-slip differential

In very unfavourable driving conditions the conventional form of differentials may be unable to transmit torque to the road wheels without one of them slipping. The limited-slip differential largely prevents this undesirable and possibly dangerous wheel slip.

The locking action is produced by lined discs and is dependent on the load exerted. The differential gear shafts, thrust rings and symmetrically located inner plates tend to move apart and brake the wheel generating the greater accelerative force.

The friction between the discs then comes increasingly into effect and hinders or entirely inhibits wheelspin on that side of the car.

A major advantage of the limited slip differential is that it comes into action automatically when needed, and does not need to be operated by the driver, who may well be fully occupied with traffic problems when wheelslip sets in.

### **Automatic ride-height control (self-leveling suspension)**

As a means of keeping the rear end of your BMW at a constant height regardless of load, the rear axle is equipped with automatic self-leveling suspension units.

As the load increases – more than two persons on board, luggage compartment filled, fuel added to tank – the car's springs compress. This movement is transferred to the control rod by a lever on the rear stabilizer, and causes the rod to move in the 'lift' direction. When the driver switches on the ignition, the hydraulic pump begins to deliver oil from the reservoir to the pressure storage chambers of the spring struts. This process continues until the vehicle has returned to its correct static load height.

When the load is removed from the vehicle, the body initially rises as on a normally sprung car. This moves the control switch in the 'lower' direction. When the ignition is switched on, the solenoid discharge valve opens and allows oil to flow back into the reservoir until the car has dropped to its static-load height again.

The continuous slight variations in body height which occur when the car is being driven – suspension movement, concerning accelerating and braking – are detected by sensors which prevent the ride height control from reacting.

To prevent the system from being overloaded, a safety switch interrupts oil delivery when the permissible rear axle load limit has been reached. If overloaded, the body will therefore sink below the normal-load position.

The ride leveling system maintains the car at its full static-load body height at all loadings

until the gross weight limit is reached, and thus ensures consistent handling, ride and correct headlight beam alignment at night regardless of whether the car is lightly or heavily laden.

During **Inspections**, the height setting and the oil level in the reservoir should be checked.

Apart from this, the ride leveling system needs no routine maintenance.

Use only Aral Vitamil 1010 or Pentosin CHF 4548 for initial filling or restoring the oil level in the system.

### **Digital motor electronics – BMW 745i**

This system uses microprocessor technology to control the volume of fuel injected and the ignition timing.

It is a development and combination of two well-established systems: L-Jetronic fuel injection and transistorized coil ignition.

Values obtained from the engine indicate its operating condition, that is to say starting information, operating voltage, speed, piston and throttle butterfly positions, air throughput and air and coolant temperatures; all these are supplied as input signals to the **control unit**.

Here they are compared with three-dimensional characteristic plots on each revolution of the crankshaft, and the best possible ignition timing angle and duration of fuel injection computed for the actual operating situation. The ignition current reaches the appropriate spark plug via a distributor with its rotor rigidly attached to the camshaft.

By taking into account these main operating factors, the digital motor electronics system ensures optimum engine performance and refinement at all times, and at the same time keeps exhaust emissions down to a minimum.

**Schematic view of digital  
electronic system  
BMW 745i**

- 1 – Control unit
- 2 – Ignition distributor
- 3 – Coil
- 4 – Heat-sensing time switch
- 5 – Coolant temperature switch
- 6 – Speed detector
- 7 – Reference mark sensor
- 8 – Spark plugs
- 9 – Air cleaner
- 10 – Throttle butterfly switch
- 11 – Battery
- 12 – Flywheel gear ring
- 13 – Fuel tank
- 14 – Electric fuel pump
- 15 – Fuel filter
- 16 – Fuel pressure regulator
- 17 – Additional air slide
- 18 – Cold-start valve
- 19 – Airflow meter
- 20 – Injectors
- 21 – Ignition/starter switch

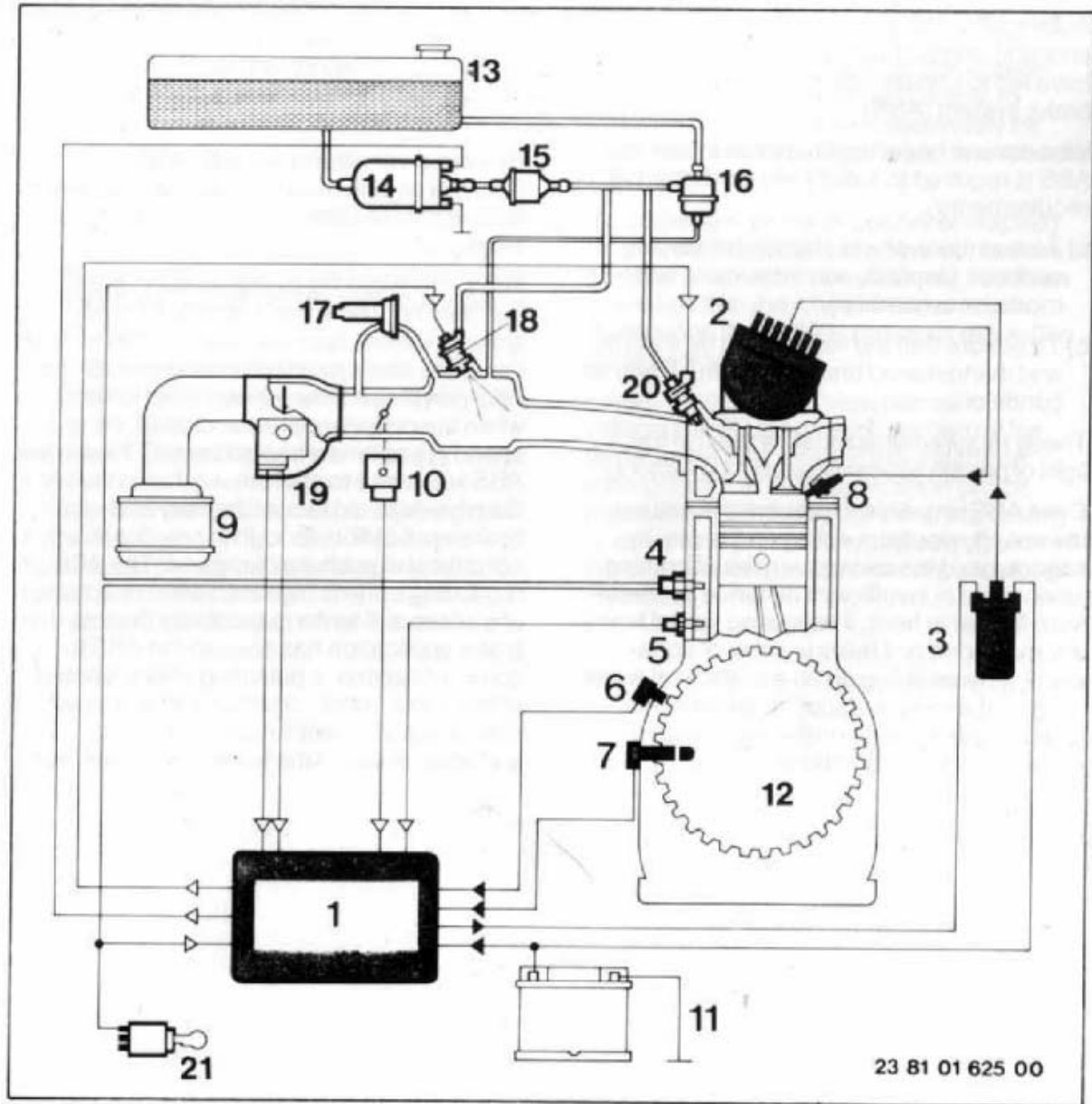

### **Antilock brake system (ABS)**

Automobile manufacturers' continuing efforts to improve vehicles' 'active safety' have led to the development of this antilock brake system (ABS).

Whenever a brake application is made, the ABS is required to satisfy two fundamental requirements:

- a) To maintain vehicle stability on varying surfaces (asphalt, concrete, mud, wet roads, snow and ice).
- b) To ensure that the vehicle can be steered and manoeuvred under the same adverse conditions.

These requirements must be seen in the light of certain essential governing factors.

Even ABS is unable to prevent the natural laws of physics from acting on the car. It cannot avoid the consequences of braking when there is insufficient distance available from the car in front, if cornering speed limits are exceeded or if there is a risk of aquaplaning (tyres riding up on a cushion of water lying on the road surface). It remains the driver's task to judge brake applications correctly in such conditions.

The fact that the car may be equipped with ABS must never, despite the increased safety margins the system frequently affords, tempt the driver into taking risks which could affect his safety and that of other road users.

#### **Driving a car equipped with ABS**

After the engine has been started, the yellow **ABS warning light** on the instrument panel will go out.

The system itself is then in working order, but does not come into action until road speed exceeds approximately 12 km/h. After this lower limit speed has been passed, the ABS can prevent the wheels from locking when the driver applies the brakes. If the speed drops below approximately 7 km/h the ABS will cease to operate, so that in theory the wheels could lock at the very end of a brake application, though in practice this is not critical at such a slow speed. The ABS's regulating cycle is repeated within fractions of a second. To inform the driver that his brake application has caused the ABS to come into action, a pulsating effect is noted at the brake pedal, together with a characteristic noise. As a warning to look out for surfaces on which the tyres cannot grip well,

an audible 'chattering' sound is present when the ABS is controlling braking pressure, and reminds the driver to reduce speed to suit poor road-surface conditions.

The ABS is capable of achieving the shortest possible braking distance under these unfavourable conditions (either in a straight line or when the steering wheel is turned, and on smooth asphalt, ice, wet roads, etc.). The braking distance may be slightly longer on loose surfaces on top of a firm base, such as snow, since the skidding wheels of a conventionally-braked vehicle tend to build up a buffer of the loose material as they are forced through it. However, the benefits of greater stability and the fact that the car can still be steered more than outweigh this circumstance.

The ABS control unit incorporates an electronic fail-safe monitoring system which checks that all components are in working order before a journey and repeatedly when the car is in motion. Any malfunction is indicated by the yellow ABS warning light on the instrument panel being illuminated. The brake system then operates conventionally and with the same standards of performance as on cars not equipped with ABS.



### Layout and operating principle

The basic factor governing any brake application is the friction between the tyre contact patch and the road surface. To brake the vehicle, the tyre must exert a frictional force on the road. A degree of slip occurs between tyre and surface, so that the peripheral speed of the wheel is not quite equal to the speed which would correspond to the car's actual road speed.

Since the tyre's contact patch is only about the size of a postcard, and moves round within approximately 6/1000 of a second at a speed of 100 km/h, it is clearly able to transmit only a limited energy potential in the form of combined longitudinal and lateral forces. A reduced friction coefficient between tyre tread and road surface cuts this energy transfer process still further. This explains why reaction at the steering wheel is still felt on surfaces with marked variations in grip although the car is equipped with ABS.

If road conditions are exceptionally unfavourable, for instance, for instance wet sheet ice or deep water (aquaplaning), even an ABS-braked wheel may come to a standstill briefly, if friction at the tyre is simply too low to turn the wheel against the residual friction in its bearings.

This effect is of course more likely to occur when the wheels are turned well away from the straight-ahead position, since the force component acting round the periphery of the wheel is then insufficient to accelerate the wheel again.

The ABS consists primarily of electronic **control unit (1)** and the **hydraulic assembly (2)** integrated into the conventional brake system of the car. **Speed sensors (3)** on the front and rear wheels measure the speed of rotation and transmit corresponding signals to the electronic control unit. This converts the rotation pulses into wheel speed and wheel peripheral acceleration, compares this data with fixed input constants and

transmits the appropriate electrical pulses to the hydraulic assembly. This consists of a group of electromagnetic valves for the various wheel brakes and an electrically-driven return-flow pump, and is able to regulate braking pressure separately for each front wheel and for the two rear wheels together.

If a wheel fails to reach a peripheral speed equivalent to the car's road speed, or if the peripheral speed drops suddenly, this is an indication that the wheel is about to lock, whereupon the braking pressure regulating cycle begins.

Pressure regulation takes place independently of pressure applied by the driver to the brake pedal; this means an emergency full brake application can be made at any time, without the driver having to vary pedal pressure repeatedly as with the often-recommended 'cadence braking' method.



**Diagram of antilock braking system (ABS)**

- 1 – Control Unit
- 2 – Hydraulic assembly
- 3 – Speed sensors
- 4 – Brake booster
- 5 – Master brake cylinder
- 6 – Brake fluid reservoir

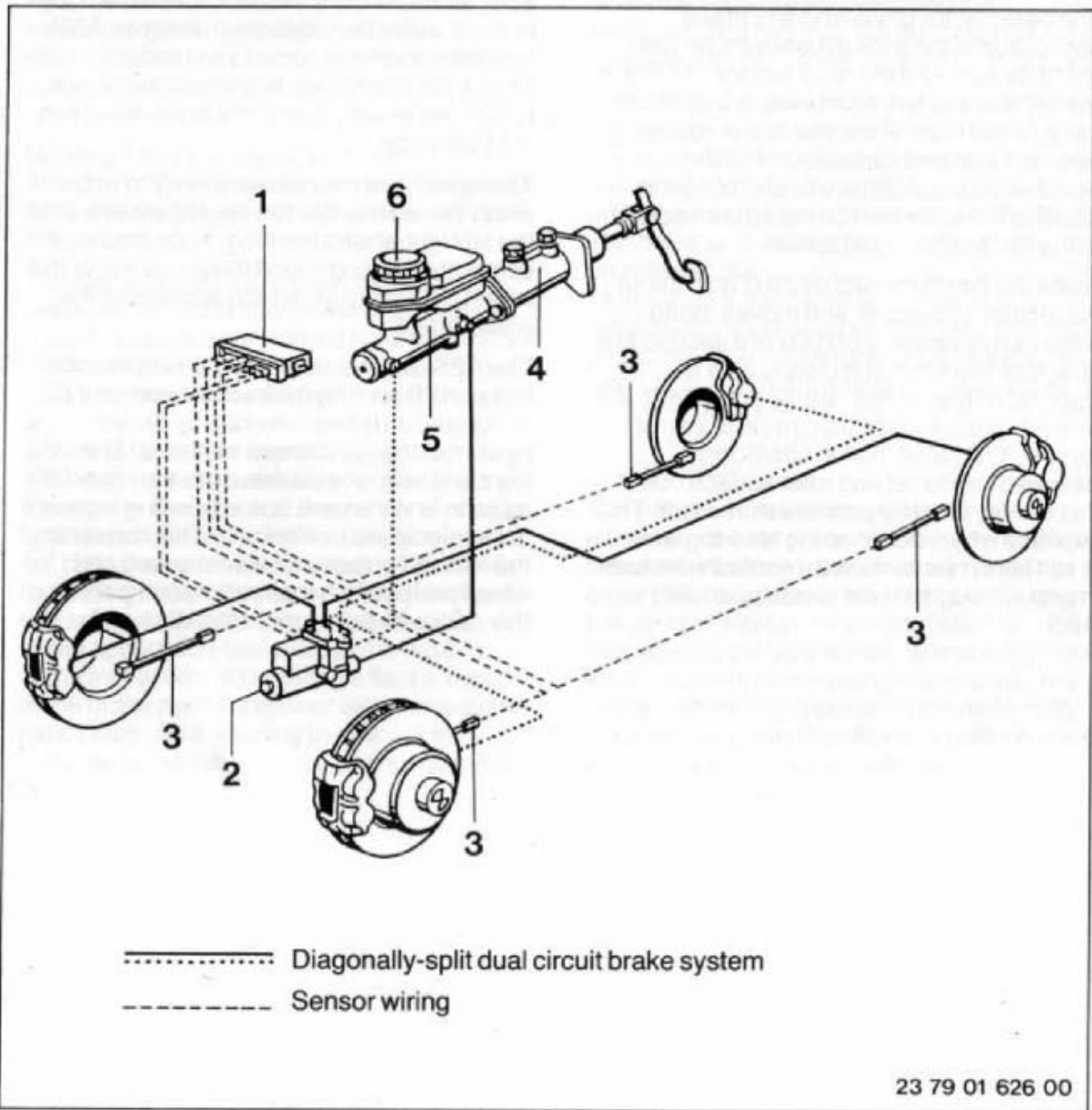

23 79 01 626 00

## Air conditioning

Your BMW is fully air-conditioned by a unit integrated into the standard heating and ventilation system. This enables the car's interior to be either raised or lowered in temperature.

The air-conditioning operates by the same principle as a domestic refrigerator. The refrigerant (Frigen 12) is raised to a high pressure in the **compressor** and then passed in gas form to the **condenser**, which is located in front of the car's radiator. The air drawn in by the cooling fan and ram air which enters when the car is moving, cool the Frigen vapour which thus liquefies again. The liquid refrigerant then flows to the **evaporator**, passing through the **dehumidifier** flask on the way. This absorbs any traces of moisture which it still contains. In the evaporator the refrigerant is released through an expansion valve and vapourized again. The heat needed for this change of state is taken from the airflow round the unit which is produced by the blower. The gaseous refrigerant is then drawn into the compressor again and recompressed to start the circuit a second time.

The compressor is equipped with an electromagnetic clutch which cuts in or out as required. It is controlled by a thermostat switch on the evaporator.

The electric auxiliary fan starts automatically when the compressor cuts in or when the refrigerant temperature reaches a certain upper limit.

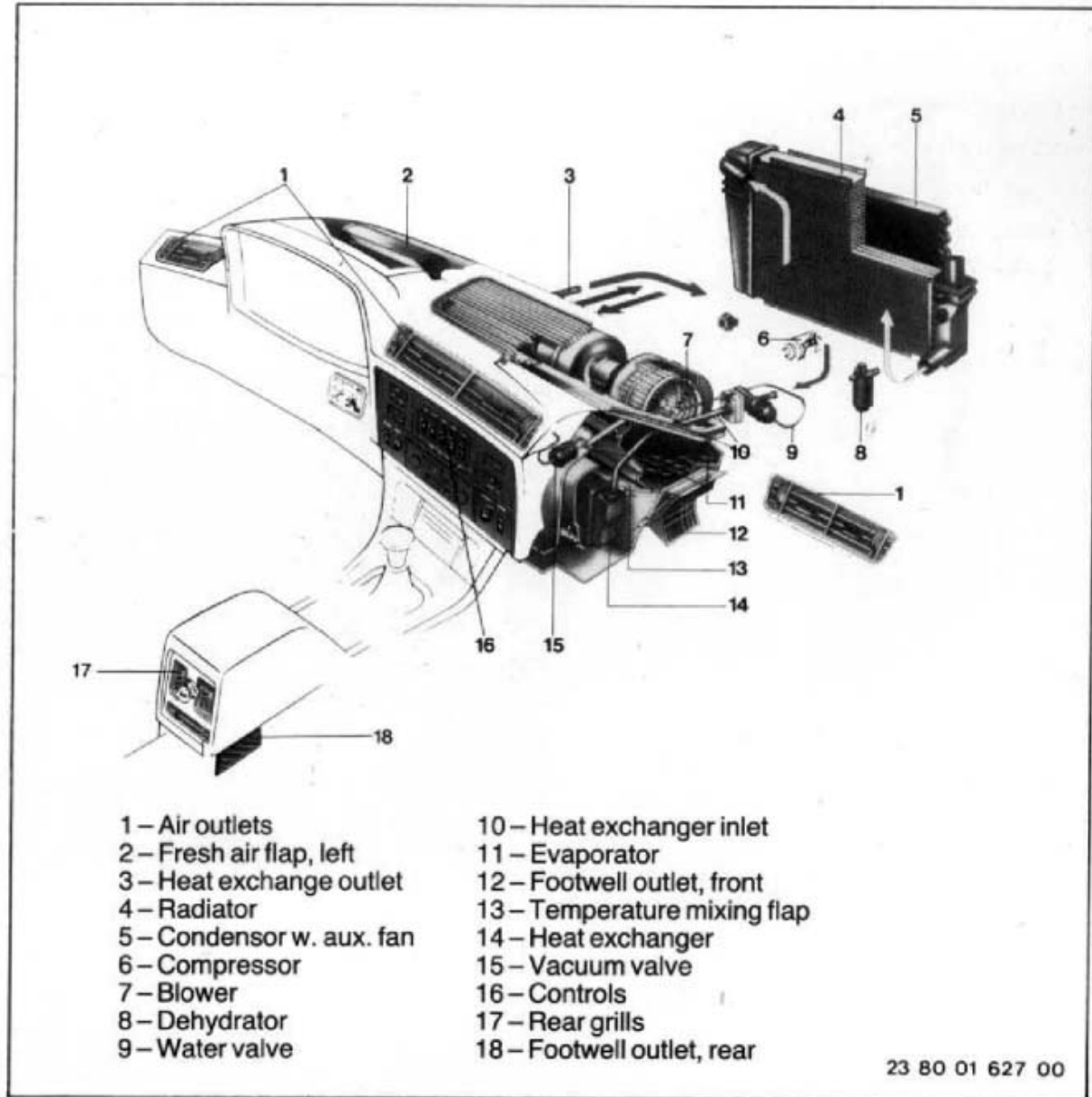

- |                           |                              |
|---------------------------|------------------------------|
| 1 – Air outlets           | 10 – Heat exchanger inlet    |
| 2 – Fresh air flap, left  | 11 – Evaporator              |
| 3 – Heat exchange outlet  | 12 – Footwell outlet, front  |
| 4 – Radiator              | 13 – Temperature mixing flap |
| 5 – Condenser w. aux. fan | 14 – Heat exchanger          |
| 6 – Compressor            | 15 – Vacuum valve            |
| 7 – Blower                | 16 – Controls                |
| 8 – Dehydrator            | 17 – Rear grills             |
| 9 – Water valve           | 18 – Footwell outlet, rear   |

23 80 01 627 00



- BMW Service
- Pre-delivery check
- Running-in Inspection
- Engine oil service
- Safety Test
- Inspection I
- Inspection II
- Annual Check
- Maintenance confirmation panels
- Alphabetical index



## BMW Service

The **BMW maintenance system** has the following objectives: to keep your vehicle safe on the roads and reliable, to maintain its resale or trade-in value and to ensure freedom from breakdowns and operating defects at minimum cost and inconvenience by offering a customer-orientated maintenance and inspection system.

The conventional method of determining maintenance and inspection intervals on motor vehicles is to relate them to the road distances covered.

In practice, however, the nature of the vehicle's operating conditions governs the need for routine maintenance, and the actual distance covered is by no means the only significant factor. One driver's miles or kilometres are not the same as another's: 100 000 km spent on short journeys in the city, with numerous cold starts and use of high engine speeds when accelerating demand a different level of maintenance and inspection compared with 100 000 km at largely constant engine temperatures and steady engine speeds about two-thirds of the way up the rev band, such as a driver mostly engaged on long journeys between towns and cities some way apart will achieve.

The technologies applied by BMW to this problem have led to the development of a servicing system which establishes the maintenance requirement not only on the basis of the distance the vehicle has

covered, but also by reference to other fundamentally important factors, for example:

Short or long individual journeys  
Hard driving or more gentle driving.

The **pre-delivery check** carried out on your new BMW will have been confirmed by the BMW service station in the panel provided on one of the following pages.

The same confirmation procedure will be followed after the **Running-in inspection at 2000 km** and for all subsequent maintenance work.

After this distance, however, maintenance is based on actual operating conditions, with the intervals indicated as follows:

- **OIL SERVICE: engine oil and filter element changed** with the engine at normal operating temperature; Safety Test included at customer's option.
- **INSPECTION:** vehicle maintenance as specified in **'Inspection I'**.
- **OIL SERVICE: engine oil and filter element change** with the engine at normal operating temperature; Safety Test included at customer's option.
- **INSPECTION:** vehicle maintenance as specified in **Inspection II**.

If the vehicle is little used, or driven only for short distances, the Inspection normally required at a certain load limit will not be reached, in which case the Service Indicator will provide the following signal after one year has elapsed:

- **INSPECTION:** vehicle maintenance as

specified in Inspection I or II, combined with Annual Check.

### Note:

If the vehicle is little used, and the "INSPECTION" indication comes up after a year in each case, the work to be performed is then as follows:

- 1st year — Inspection I with Annual Check
- 2nd year — Inspection II with Annual Check

These routines then alternate in succeeding years, assuming that the use to which the vehicle is put does not change. The official inspection work (if the service station is entitled to perform it according to national regulations) can be included at the customer's option.

When the BMW service station has performed the indicated maintenance work, confirmation will be entered in the appropriate panels and the Service Indicator will be reset to cancel its reading.

Make quite sure that confirmation of maintenance work is always entered. You will need this for any warranty claims that become necessary, and later on as evidence that your car has been given correct and regular maintenance.

The **Service Indicator** consists of five green, one yellow and three red light-emitting diodes (LED) and the inscriptions "OIL SERVICE" and "INSPECTION".

Whenever the ignition is switched on, **up to five green LEDs** will light up, depending on the amount of use the vehicle has already had since the last servicing routine and your driving style. As the number of illuminated

green LEDs grows less, this is an indication that the next servicing routine is about to fall due and helps you to make the necessary arrangements in good time.

The green LEDs go out when the engine is started.

If the **yellow LED** and one of the inscriptions also come on with the ignition and remain on when the engine is started, the next maintenance routine is due immediately.

If the maintenance interval has been exceeded, the **red LEDs** will come on successively in addition to the yellow one to remind you of the urgent need for servicing. In the interests of road safety and reliability, you should **avoid driving your BMW when the red LED signals are showing**, but have the essential maintenance work performed without delay.

The Oil Service indication is cancelled as soon as the necessary work has been performed. The green LEDs which then come on with the ignition show you the interval before the next Inspection is due.

If the car is driven for a year without any maintenance work becoming necessary as a result of normal wear and tear, the yellow LED and the Inspection inscription will come on after this period. You should then submit the car for Inspection I or II, according to which would normally be due, together with the Annual Check.





## PRE-DELIVERY CHECK (FREE OF CHARGE)

(Vehicle's preservative waxing removed in accordance with factory directives; vehicle cleaned)

### Body:

- Checking that type plate details, chasis and engine numbers are correct.
- Comparing delivered specification with order details.
- Installing wheel hub caps or wheel trim rings and exhaust tailpipe trim as necessary.

- Intalling tools in tool tray, securing jack and wheel stud wrench.

### Inside engine compartment:

- Checking engine oil level and correcting if necessary.
- Check power steering for leaks.
- Checking tension and condition of all V-belts; retensioning if necessary.
- Checking liquid in reservoir for brake and clutch hydraulics and topping up if necessary.
- Checking coolant hoses for leaks, taking up any slack at hose clips, checking coolant level and topping up if necessary.
- Checking positioning, condition and freedom from leaks of fuel pipes, fuel tank and hoses.

- Checking liquid level and antifreeze concentration in windshield washer reservoir, and correcting as necessary.
- Checking battery acid level and topping up with distilled water if necessary
- Taking up any slack at nuts and bolts on exhaust manifold.
- L-Jetronic fuel injection: tightening the clips and screws at the injector holders.
- Check engine idle speed and adjust if necessary.

### Transmission, other threaded connections:

- Take up any slack at nuts and bolts on: steering box and brake caliper mountings, half-shafts, front axle, joint disc, track rods. (Note correct tightening torques; inspect castellated nuts to ensure that the split pins have not been lost.)

### Rear axle and wheels:

- Check that wheel studs are tightened to the specified torque.
- Check that wheel rim size, tyre size and tyre pressures are correct (including spare wheel).
- Inspect connections and lines on brake system for leaks, damage or incorrect positioning.
- Check rear wheel alignment.

### Electrical system:

- Check the lights: parking, turn indicator, rear, brake and reversing (back-up) lights, rear fog light(s), licence plate, interior, glove box and luggage compartment lights.
- Check horn, headlight flasher and hazard warning flashers.
- Check instrument and inscription lighting.
- Check operation of tell-tale and warning lights on the instrument panel and in the Check-Control unit.
- Check operation of the wipers and windshield washer: wiper blades (remove protective sleeves), washer jet aiming and delivery.
- Check operation of cigar lighter.
- Check operation of heating, ventilation system and blower.
- Check operation of centralized locking system.
- Radio: check antenna trimming and tune to a suitable station. With the engine running, check interference suppression by switching on all electrical consumers.
- Check operation of all other optional extras.

This sheet remains with the BMW authorized dealer after the pre-delivery check has been carried out.  
The BMW authorized dealer will confirm that the pre-delivery check has been performed correctly in the space provided.

**Other items:**

- Place owner's handbook, list of BMW service stations, spare keys and key wallet in glove box.
- Check operation of engine, clutch, transmission, rear axle, steering, foot brake and handbrake. On rear disc brakes, bed down the handbrake. On cars with ABS: check operation to tell-tale light.
- Check operation of instruments: speedometer, distance and trip recorders, revolution counter-clock, coolant thermometer and fuel gauge.
- Check engine, transmission, steering, final drive, half-shaft gaiters, fuel, clutch, cooling and brake systems for leaks.
- Activate the Service Indicator in accordance with factory directives.
- Remove temporary seat covers.

**Delivery to vehicle owner:**

I hereby confirm that I have taken delivery of the  
BMW ..... with chassis number .....  
in satisfactory condition.

**The car was accompanied by:**

- Owner's handbook
- List of BMW service stations
- Spare keys with key number label
- Key wallet
- Tools complete with jack and wheel stud wrench
- Wrenches for manual operation of electric window lifts/sliding roof.

---

(Place, date)

---

(Signature of vehicle owner)



## BMW Running-in Inspection

### at 2 000 km speedometer reading

- Change engine oil and filter element at normal operating temperature.
- Change oil in manual gearbox or automatic transmission at normal operating temperature.
- Change oil in final drive (rear axle) at normal operating temperature.
- Check power steering for leaks, check oil level and add oil if necessary.
- Check level of fluid in reservoir for brake and clutch hydraulic systems, and top up if necessary.
- Check coolant hoses for leaks. Check coolant level and concentration and correct if necessary.
- Take up any slack at nuts and bolts on steering, exhaust system, brakes, wheels (note correct tightening torques).
- Check condition, position, mountings and freedom from leaks at exhaust system.
- Check foot brake and handbrake and adjust handbrake cables.
- Check tyre pressures and correct if necessary.
- Inspect brake system connections and lines for leaks, damage and incorrect positioning.
- Check lighting: parking, turn indicator, rear, brake and reversing (back-up) lights, rear fog lights licence plate, interior, glove box and luggage compartment lights.
- Check operation of horn, headlight flasher and hazard warning flashers.
- Check instrument and inscription lighting.
- Check operation of ABS (antilock braking system) warning light.
- Check liquid level and antifreeze concentration in windshield washer reservoir, and correct if necessary.
- Check wipers and windshield washer blades, washer jet aiming.
- Adjust engine idling and check exhaust emissions; adjust if necessary.
- Final check with road-safety test (brakes, including bedding down handbrake linings on cars with rear disc brakes, steering, clutch or automatic transmission). Check operation of heater blower. Check tell-tale and warning lights on instrument panel and in Check-Control unit.

## BMW Engine Oil Service

### (with option of BMW Safety Test)

Change engine oil and renew oil filter element while at normal operating temperature.

## BMW Safety Test

### Check steering:

steering box, steering linkage, joint disc, threaded connections, freedom from leaks, oil content, V-belt tension and condition on cars with power steering.

### Check brakes:

brake pads, brake discs, pipes, hoses, connections, fluid level, handbrake cables, handbrake adjustment. Rear disc brakes: bed down the handbrake linings.

**Important:** brake fluid must be renewed at least once a year.

### Check tyres and wheels:

condition, tyre pressures, correct sizes.

### Check lighting:

headlights, additional driving lights, (including beam settings), parking, rear and reversing (back-up) lights, licence plate, instrument and inscription lighting, tell-tale and warning lights.

### Check warning systems:

horn, turn indicators, hazard warning flashers, brake lights, headlight flasher, rear fog lights.

### Check windshield wipers and washers:

wiper blades, washer system for windshield, fluid reservoir (level, antifreeze protection), washer jet aiming (windshield).

### Check seat belts:

condition and correct operation.

### Check exhaust emission:

engine must be at normal operating temperature.

### Note:

Any repair and adjustment work needed will be billed to the customer as incurred.



## BMW Inspection I

- Renew the spark plugs
- Change the engine oil and renew the oil filter element at normal operating temperature.
- Check gearbox oil level and top up if necessary
- Check final drive (rear axle) oil level and top up if necessary.
- Check power steering for leaks and restore correct oil level if necessary.  
**Important:** coolant must be drained completely and renewed every two years.
- Check battery terminals.
- Check fluid level in reservoir for brake and clutch hydraulic systems, and top up if necessary.  
**Important:** brake fluid must be renewed at least once a year.
- Check tension and condition of all V-belts and correct tension if necessary. Renew if necessary (to be billed to customer as a separate item).
- Air-conditioning: take up slack at compressor mounting bolts.
- Oil pivots and bearing points of throttle butterfly actuating linkage, or grease the throttle butterfly lever pivot points and gate.
- Take up any slack at nuts on exhaust manifold.
- Inspect fuel lines, fuel tank and hoses for correct positioning, condition and freedom from leaks. Renew the main fuel filter (throwaway element).
- Check valve clearances and adjust if necessary.
- Intake air cleaner: renew filter element. Renew at more frequent intervals in very dusty conditions.
- Check for freedom from play at steering, and adjust as necessary. Check condition of track rod and front axle pivots. Check steering box, linkage and joint disc.
- Check condition, positioning, mounting and freedom from leakage on exhaust system.
- Remove all install front disc brake pads (and rear pads if necessary), check overall thickness and renew pads if necessary. Examine brake disc surfaces. On light alloy wheels, grease the positive wheel centering spigots.
- Check tyre pressures and correct if necessary. Check condition of tyres; if worn unevenly, measure and adjust wheel alignment (to be billed as a separate item).
- Check brake system connections and lines for leaks, damage and incorrect positioning. Clean linings and drums for foot brake and examine for wear. Inspect wheel brake cylinders and dust sleeves for leaks. Check free movement of handbrake cables. Adjust handbrake.
- Take up any slack at door and lid catches and oil or grease them. Check correct operation.
- Self-levelling suspension: check oil level in tank with vehicle unladen, and correct if necessary.
- Check headlights and auxiliary driving lights.
- Check lighting equipment: parking turn indicator, rear, brake and reversing (back-up) lights, rear fog lights licence plate, interior, glove box and luggage compartment lights.
- Check horn, headlight flasher and hazard warning flashers.
- Check instrument and inscription lighting.
- Check operation of ABS (antilock braking system) warning light.
- Check fluid level and antifreeze concentration in windshield washer reservoir, and correct if necessary.
- Check wipers and washer system: wiper blades, washer jet aiming.
- Check condition and operation of seat belts.
- Sliding/vent roof: grease slide rails.
- Engine test in accordance with factory directives. Check engine idling an exhaust emission settings and adjust if necessary.
- Final check with road safety test: brakes (bedding down handbrake linings if car has rear disc brakes), steering and power assistance, clutch or automatic transmission, springs and shock absorbers (visual inspection), mirrors. Check operation of heater blower. Check operation of tell-tale and warning lights in instrument cluster and in Check-Control unit.

## BMW Inspection II

Includes all items listed under Inspection I, and the following additional checks and maintenance operations:

- Change oil when at normal operating temperature in manual gearbox or automatic transmission, and in final drive (rear axle).
- Renew oil mesh strainer for automatic transmission.
- Check clutch driving plate for wear.
- Front wheel bearings: check play.
- Rear disc brakes: check thickness of handbrake linings.
- Half-shafts: check for leaks at flexible gaiters.

## BMW Annual Check

- Renew brake fluid; every two years, renew coolant (to be billed separately).
- Inspect entire body with the exception of cavities for signs of corrosion.
- Inspect load-bearing body elements for corrosion, fracture or cracks; if repair work is necessary, test in accordance with BMW directives.
- Check steering: left and right lock limits, threaded connections, power steering system.
- Brakes: Check operation of master cylinder and booster, and inspect for leaks.
- Check operation and beam settings of headlights and auxiliary driving lights.

Note: Repairs or respraying on bodywork and renewed parts are billed additionally.



## Service – all the way

High quality engineering inspires confidence. You need not drive your new BMW very far to discover this.

A high quality automobile should be given expert attention and care, so that your driving pleasure remains undisturbed for many years.

Try to have your BMW serviced or repaired at an authorized BMW workshop – always. All the equipment and facilities are specially tailored to BMW and the workshop is required by contract to install only genuine BMW parts on your car.

You should always be suspicious when offered other parts of allegedly equivalent quality, since we are unable to test them and vouch for their suitability.

Furthermore, our warranty terms may be affected.

Genuine BMW parts protect you against all such difficulties and reduce the risk to which you are exposed on the roads. Genuine BMW parts are not merely 'spares' but identical with the parts originally fitted to your car.

**Replacement of one 'original part' by another ensures that the superior design and engineering concept of every BMW is maintained, so that you can make full and safe use of your car's performance.**

Every BMW dealer is required to keep full stocks of the following Genuine BMW parts:

All parts frequently needed as replacements or exchange on BMW cars.

Genuine BMW accessories (the full factory-approved range).

Genuine BMW parts which are less frequently called for – from a range of about 48 000 items – are obtained by smaller dealers from their larger associates in the BMW dealer network or from the national BMW importer's stock.

Genuine BMW parts are all those parts, accessories and assemblies which are supplied by the Bayerische Motoren Werke AG, regardless of whether they are manufactured by BMW or obtained from approved outside suppliers.

**For safety reasons you are recommended to install only Genuine BMW Accessories.**

## Quality Guarantee

Genuine BMW Parts are entirely identical with the equivalent parts used on new BMW vehicles.

The Bayerische Motoren Werke AG guarantees that these parts are genuine and free from defects in materials or workmanship.

BMW – Perfection in Detail

**Genuine  
BMW Parts**



Look for this sign!

## Index

- Acceleration 6-19  
Accessories range 2-32  
Acid level 4-14  
Air cleaner 6-4  
Air-conditioning, automatic 2-30 – 6-19 – 6-20  
Air distribution 2-31  
Air extraction 2-31  
Alternator 6-16  
Antenna 2-46 – 5-3  
Antifreeze 4-19  
Antilock braking system 6-34  
– warning light 1-4 – 2-12 – 3-7 – 5-8  
Armrests 2-19  
Ashtrays 2-20  
Automatic transmission 2-24 – 2-25 – 6-6 – 6-27 – 6-28  
– oil change 6-20  
– oil content 1-8  
– oil cooler 6-6  
– oil grades 6-22  
– oil level check 4-11  
– ratio 6-6  
Automatic speed control 2-25  
Automatic transmission selector lever  
  position indication lights 2-12 – 2-24  
Axle loads, permissible 6-17
- Backup lights 2-15 – 2-18 – 5-17  
Battery 4-14 – 6-16  
Battery acid level 4-14  
Battery charge tell-tale 2-12 – 3-6 – 5-12 – 5-19  
Battery charging 4-14  
BMW Parts and Exchange Service 7-16  
BMW range of accessories 2-32  
BMW Safety Test 7-13  
BMW Service 7-2 – 7-3
- Body 6-13  
Body cavity sealing 5-02  
Body dimensions 6-17 – 6-18  
Body overhang 6-17  
Brake booster servo 4-15 – 6-11  
Brake discs 6-11  
Brake fluid and clutch fluid reservoir 4-12  
Brake fluid renewal 3-8 – 4-12 – 6-21  
Brake lights 6-11 – 5-17  
Brake pad wear indicator light 1-4 – 2-12 – 5-8  
Brake warning light 1-4 – 2-12 – 3-6 – 5-8 – 5-9 – 5-19  
Brakes 4-12 – 4-16 – 4-17 – 4-22 – 6-11 – 6-12  
Braking distances 6-12  
Bulb changing 5-16 – 5-17 – 5-18  
Bulbs 5-16 – 5-17 – 5-18
- Camber angle 6-7 – 6-8  
Capacities 1-8  
Caravan towing 4-22 – 4-23 – 4-24  
Care of car 5-25  
Cassette player 2-39 – 2-50 – 5-3  
Caste angle 6-7  
Centre armrest 2-19  
Central locking system 2-4  
Central warning light 2-15  
Chassis number 2-5  
Check-Control 2-15 – 3-6 – 5-9  
Child's seat 3-4 – 3-5  
Chromium, case of 5-2  
Cigar lighter 2-20  
Clock 2-14  
Clutch 6-16  
Coil 6-16  
Cold weather operation 4-19 – 4-20  
Compression ratio 6-5  
Computer, on-board 2-34 – 2-35  
Connecting rods 6-2  
Coolant 4-19  
Coolant level, checking 4-13 – 5-9  
Coolant temperature tank 4-13  
Coolant thermometer 5-8 – 5-9
- Coolant thermostat 6-6  
Cooling system 4-13 – 4-19 – 6-6  
Cooling system capacity 1-8  
Corrosion protection 5-2  
Crankshaft 6-2  
Cruise control 2-25  
Cylinder block 6-2  
Cylinder head 6-3
- Defrosting windows 2-21 – 2-28 – 2-30  
Differential 6-6  
– oil change 6-20  
– oil content 1-8  
– oil grades 1-8  
– ratio 6-6  
Digital clock 2-14  
Digital motor electronics 1-9 – 3-8 – 5-7 – 5-19 – 6-16 – 6-36 – 6-31  
Dimensions 6-17 – 6-18  
Dipped beams 2-8 – 5-16 – 6-16  
Dipstick 4-10 – 4-11  
Disc brakes 4-15 – 4-16 – 5-8 – 5-11  
Displacement (engine) 6-5  
Distributor 6-16  
Door lock heating 2-2  
Door locks 2-2 – 2-4 – 4-19  
Downhill gradients 4-24  
Driver's seat 1-2 – 2-6 – 3-2  
Driver's seat adjustment 1-2 – 2-6 – 3-2  
Driving hints 4-2 – 4-24  
Driving your BMW 1-2 – 1-10  
Dust caps (tyre valves) 4-17 – 6-9
- Economy 4-1 – 4-9  
Electrical system 6-16  
Energy control 2-13  
Engine breather 6-4  
Engine capacity 6-5  
Engine compartment light 2-18 – 5-18  
Engine compartment lock 2-4 – 2-5  
Engine data 6-2 – 6-3 – 6-5  
Engine lubrication 6-3



Engine oil change 6-20  
Engine oil content 1-8  
Engine oil cooler 6-6  
Engine oil consumption 4-10 – 6-4  
Engine oil filter 1-8 – 6-4  
Engine oil grades 4-11  
Engine power output 6-5  
Engine specifications 6-2 – 6-3 – 6-5  
Engine speed – continuous 6-5  
Engine speed – maximum 6-5  
Engine speed 6-5

Fan 6-6  
Fault tracing 5-19  
Filling capacities 1-8  
Final drive 6-6  
– oil change 6-20  
– oil content 1-8  
– oil grades 1-8  
– ratio 6-6  
Firing order 6-16  
First aid box 2-19  
Flat battery 5-12  
Floor mats 5-3  
Flying stones 5-2  
Fog lights 2-11 – 3-8  
Foot-brake 4-12 – 4-16 – 4-22 – 6-11 – 6-12  
Foreign travel 4-20  
Front suspension 6-7  
Fuel 1-8 – 2-40 – 4-2  
Fuel consumption 4-2 – 4-9 – 6-5  
Fuel economy 4-2 – 4-9  
Fuel filler 2-14 – 1-7 – 5-14  
Fuel filters 6-4  
Fuel gauge 1-3 – 2-14  
Fuel injection system 6-25  
Fuel pump 6-4  
Fuel reserve 2-14  
Fuel tank capacity 1-8 – 6-13  
Fuel tell-tale lamp 1-3 – 2-14  
Fuels and lubricants 6-20 → 23  
Fuses 5-15

Gearbox 2-22  
Gearbox gate pattern 1-6 – 2-22  
Gearbox oil capacity 1-8  
Gearbox oil change 6-20  
Gearbox oil grades 1-8  
Gearbox ratios 6-6  
Glove box 2-19  
Gradients 4-24  
Gross weight, permissible 6-17  
Ground clearance 6-17

Hand lamp, rechargeable 2-19  
Handbrake 2-23  
Hazard warning flashers 2-21  
Head and side light switch 1-3 – 2-8  
Head restraints 1-2 – 2-7 – 3-2  
Headlight beam adjuster 3-7  
Headlight beam setting 3-7  
Headlight flasher 1-3 – 2-9  
Headlights 5-16 – 6-16  
Heated rear window 3-8  
Heated rear window push-button switch 2-21  
Heater 6-15  
Heating and ventilation 2-28-29 – 6-15  
Height 6-17  
High beam headlights 2-9 – 5-16  
High beam headlight tell-tale 1-4 – 2-12  
Hoist pickup points 6-21  
Horn pushes 2-18  
Horns 2-18

Ignition starter switch 1-3 – 2-8  
Injection system 6-25  
Inspection 7-8 – 7-14 – 7-15  
Instrument lighting 2-8  
Instruments 1-4 – 2-12  
Intake air path 6-4  
Interior light 2-11 – 5-18  
Interior mirror 2-16  
Intermittent wiper action 2-9  
International symbols 6-17

Jack 5-5

Keys 2-2  
Kick-down 2-25  
Kingpin inclination 6-7

Laying up out of use 5-4  
Leather 5-3  
Left-hand traffic 4-20  
Length 6-17 – 6-18  
Licence plate lights 5-17  
Lifting points for vehicle hoist 6-21  
Light switch 1-3 – 2-8  
Lights 5-16 – 5-17 – 5-18 – 6-16  
Lighter 2-20  
Limited slip differential 6-10 – 6-29  
Locks 2-2 – 2-3 – 2-4 – 4-19  
Loudspeaker front/rear balance control 2-21  
Low beam headlights 2-8 – 5-16 – 6-16  
Luggage compartment 6-13  
Luggage compartment light 2-18 – 5-18  
Luggage compartment lock 2-3 – 2-4

Main beam 2-9 – 5-16  
Main beam tell-tale 1-4 – 2-12  
Maintenance 7-2  
Minor defects 5-19  
Mirror, outside 2-16  
Modifications 3-8  
Motronic 6-30 – 6-31

Number-plate lights 5-17

Octane number 1-8 – 2-50 – 4-2  
Oil additives 4-10  
Oil changes 6-20  
Oil consumption 4-10 – 6-4

Oil content 1-8  
Oil cooler 6-6  
Oil filter 1-8 – 6-4  
Oil grades 6-22  
Oil level, checking 4-11  
Oil pressure tell-tale 1-4 – 2-12 – 3-6 – 5-9 – 5-19  
On-board computer 2-34 – 2-35  
Operating instructions 2-2  
Operating temperature 2-14 – 5-9 – 5-19  
Output per litre 6-5  
Overhang 6-22

Paintwork lights 4-19 – 5-2  
Paintwork damage 5-12  
Parking lights 2-9 – 5-16  
Parts 7-16  
Performance 6-5  
Performance graph 6-8  
Pistons 6-2  
Power output 6-5  
Power socket 2-20  
Power steering 4-12 – 5-19 – 6-9 – 6-29  
– oil content 1-8  
– oil grades 6-23  
– ratio 6-9  
Power/weight ratio 6-5  
Propeller shaft 6-6  
Punctures 5-5

Radial ply tyres 3-8 – 4-17 – 4-18 – 6-9 – 6-10  
Radiator cap 4-13 – 5-9 – 6-6  
Radio 2-37 – 2-38 – 2-40 – 2-41 – 2-46  
Radio antenna 2-46 – 5-3  
Reaction times 6-12  
Reading lamps 2-11  
Rear fog light 2-11 – 2-18 – 3-8  
Rear lights 2-18 – 5-17  
Rear seat heating outlets 2-31  
Rear seats 2-19

Rear seats, electrically adjustable 2-7  
Rear suspension 2-8  
Rear window shelf 3-8  
Reflectors 2-18  
Refuelling 1-7  
Regulator (voltage) 2-16  
Reverse gear, selecting 2-23  
Reversing lights 2-18 – 2-23 – 5-17  
Revolution counter 1-3 – 2-13  
Ride height control 6-30  
Rims 6-10  
Roof load, permissible 6-17  
Rubber components 4-17 – 5-3  
Running-in rules 2-52  
Running-in brakes and tyres 2-52

Safety 3-2 → 3-8  
Safety Test 3-8  
Seat adjustment 1-2 – 2-6 – 3-2  
Seat memory 2-6  
Seat belts, automatic-reel 1-6 – 2-7 – 3-3 – 5-3  
Selector lever position indicating lights 2-12 – 2-24  
Self-levelling suspension 6-30  
Service 7 →  
Service Indicator 2-12 – 5-9  
Sliding/vent roof 2-26 – 5-9  
Socket 2-20  
Spark plugs 1-9 – 6-16  
Spare wheel 5-5  
Specifications 6 →  
Speedometer 1-3 – 2-13  
Speed control 2-26  
Spinning rear wheels 4-19  
Stains 5-3  
Starter 6-16  
Starting aids 5-7 – 5-11 – 5-12  
Starting difficulties 5-7  
Starting the engine 3-6  
Starting with flat battery 5-12  
Steering 4-12 – 5-9 – 5-19 – 6-9 – 6-29  
– oil content 1-8

– oil grades 6-23  
– ratio 6-9  
Steering column adjustment 1-2 – 2-6 – 3-2 – 6-9  
Steering lock 1-6 – 2-8  
Steering wheel reach adjustment 2-6 – 3-2 – 6-9  
Stop lights 2-18 – 5-17  
Sun visors 2-17 – 3-2  
Suspension 6-7 – 6-8

Tape head cleaning 5-3  
Tape replay 2-43  
Tar stains 5-3  
Technical descriptions 6-25 – 6-35  
Tell-tale lamps 1-4 – 2-12  
Thermostat 6-6  
Thermometer 1-3 – 2-14  
Tyre dimensions, changing 4-18  
Tyre markings 4-18  
Tyre pressures 1-9  
Tyre repairs 5-6  
Tyre treads 4-17  
Tyre valve caps 4-17 – 6-9  
Tyres 3-8 – 4-17 – 4-18 – 6-9 – 6-10  
Toe-in 6-11 – 6-9  
Toe-out on turns 6-7  
Toolkit 5-10  
Top speed, maximum permitted 6-19  
Torch, rechargeable 2-19  
Torque 6-5  
Torque converter 6-28 – 6-29  
Torque graph 6-5  
Tow starting 5-11  
Towbar downthrust, permissible 4-22 – 4-23 – 6-17  
Towing a trailer 4-22 – 4-24  
Towing away 5-11  
Towing eyes 5-11  
Track 6-17  
Track rods 6-9  
Trailer load, permissible 6-17  
Trailer nose weight 6-17  
Trailer towing 4-22 → 4-24  
Transmission oil cooler 6-6



Trip distance recorder 1-3 – 2-13  
Trouble-shooting 5-19  
Tuning (radio) 2-37 – 2-38  
Turn indicator lever 1-3 – 2-9  
Turn indicator tell-tale 1-4 – 2-9 – 2-12  
Turn indicators 2-18 – 5-17  
Turning circle 6-17  
Type plate 2-5

Valve clearances 6-3  
Valves 6-3  
V-belts 1-9 – 6-14  
Vehicle hoist lifting points 6-23  
Ventilation 1-5  
Voltage regulator 6-16

Warming up 4-2  
Water patches on paintwork 5-2  
Weight 6-17  
Weight, gross 6-17  
Wheelbase 6-17  
Wheel changing 4-18  
Wheel chock 5-5  
Wheel lock 6-7  
Wheel stud wrench 5-6  
Wheels 6-9 – 6-10  
Wheels, interchanging 4-18 – 5-5 – 5-6  
Width 5-17  
Window lift circuit breaker 2-17  
Window lift switches 2-17  
Window lift, electric 2-17  
Window lifts, hand operation 5-14  
Windows 6-13  
Windshield washer 2-9 – 2-10 – 4-13  
Windshield washer fluid tank 2-10  
Windshield washer jets 2-10  
Winter operation 4-19 – 4-20  
Wipe/wash lever 1-3 – 2-9  
Wiper arms 5-13  
Wiper blades 3-8 – 5-13  
Wipers 5-13