



**Owner's Manual for the Vehicle.
With a quick reference guide
for your convenience.**



M5



M5

Congratulations, and thank you for choosing a BMW.

Thorough familiarity with your vehicle will provide you with enhanced control and security when you drive it. We therefore have this request:

Please take the time to read this Owner's Manual and familiarize yourself with the information that we have compiled for you before starting off in your new car. It contains important data and instructions intended to assist you in gaining maximum use and satisfaction from the unique range of technical features on your BMW. The manual also contains information on care and maintenance designed to enhance operating safety and contribute to maintaining the value of your BMW throughout an extended service life.

This Owner's Manual should be considered a permanent part of this vehicle. It should stay with the vehicle when sold to provide the next owner with important operating, safety and maintenance information.

This manual is supplemented by a Service and Warranty Information Booklet (US models) or a Warranty and Service Guide Booklet (Canadian models). We recommend that you read this publication thoroughly.

Your BMW is covered by the following warranties:

- ▷ New Vehicle Limited Warranty
- ▷ Limited Warranty Rust Perforation
- ▷ Federal Emissions System Defect Warranty
- ▷ Federal Emissions Performance Warranty
- ▷ California Emission Control System Limited Warranty

Detailed information about these warranties is listed in the Service and Warranty Information Booklet (US models) or in the Warranty and Service Guide Booklet (Canadian models).

We wish you an enjoyable driving experience.

BMW AG

Notes on the Owner's Manual

We have made every effort to ensure that you are able to find what you need in this Owner's Manual as quickly as possible. The fastest way to find certain topics is by using the detailed index at the end. If you desire an initial overview of your vehicle, this can be found in the first chapter. The detailed list of contents that directly follows the summary of contents is intended to stimulate your curiosity regarding your BMW and to encourage you to read the manual.

Should you wish to sell your BMW at some time in the future, please remember to hand over the Owner's Manual to the new owner; it is part of the vehicle.

Should you have any further questions, your BMW center will be glad to assist at any time.

© 1999 BMW M GmbH
Munich, Germany
Reprinting, including excerpts, is permitted only with the express written approval of BMW M GmbH, Munich.
Order no. 01 41 0 155 062
US English VIII/99
Printed in Germany
Printed on environmentally friendly paper (bleached without chlorine, suitable for recycling)

Symbols used



These sections contain vital information – please read the accompanying text passages carefully, both for the your own safety and to prevent damage to your BMW. ◀



Indicates notes that alert you to specific features of your vehicle. ◀



Special information on recycling. ◀

◀ Indicates the end of a block of information.

* Indicates special equipment, country-specific equipment and optional extras.



Indicates that you should consult the relevant section of this Owner's Manual for information on a particular part or assembly.



Alerts you to functions that can be adjusted by your authorized BMW center ("Car Memory" or "Key Memory"). Refer to page 52.

The individual vehicle

On buying your BMW, you have decided in favor of a model with individualized equipment and fittings. This Owner's Manual describes all models and equipment that BMW offers within the same group.

We hope you will understand that equipment and features are included that you might not have chosen for your vehicle. Any differences can easily be identified, since all optional accessories and special equipment are marked with an asterisk *.

If your BMW features equipment that is not described in this Owner's Manual (a car radio or telephone, for instance), we have enclosed Supplementary Owner's Manuals. We ask you to read these manuals as well.

Status at time of printing

BMW pursues a policy of continuous, ongoing development that is conceived to ensure that our vehicles continue to embody the highest quality and safety standards combined with advanced, state-of-the-art technology. For this reason, it is possible that the features described in this Owner's Manual could differ from those on your vehicle. Nor can errors and omissions be entirely ruled out. You are therefore asked to appreciate that no legal claims can be entertained on the basis of the data, illustrations or descriptions in this Owner's Manual.

For your own safety

 Use unleaded gasoline only. Fuels containing up to and including 10 % Ethanol or other oxygenates with up to 2.8 % oxygen by weight (that is, 15 % MTBE or 3 % methanol plus an equivalent amount of co-solvent) will not void the applicable warranties respecting defects in materials or workmanship. Field experience has indicated significant differences in fuel quality (volatility, composition, additives, etc.) among gasolines offered for sale in the United States and Canada. The use of poor-quality fuels may result in driveability, starting and stalling problems, especially under certain environmental conditions such as high ambient temperature and high altitude. Should you encounter driveability problems that you suspect could be related to the fuel you are using, we recommend that you respond by switching to a recognized high-quality brand. Failure to comply with these recommendations may result in unscheduled maintenance. Follow the relevant safety rules when you are handling gasoline. ◀



Important safety information!

For your own safety, use genuine parts and accessories approved by BMW.

When you purchase accessories tested and approved by BMW and Original BMW Parts, you simultaneously acquire the assurance that they have been thoroughly tested by BMW to ensure optimum performance when installed on your vehicle.

BMW warrants these parts to be free from defects in material and workmanship.

BMW will not accept any liability for damage resulting from installation of parts and accessories not approved by BMW.

BMW cannot test every product from other manufacturers to verify if it can be used on a BMW safely and without risk to either the vehicle, its operation, or its occupants.

Original BMW Parts, BMW Accessories and other products approved by BMW, together with professional advice on using these items, are available from all BMW centers.

Installation and operation of non-BMW approved accessories such as alarms, radios, amplifiers, radar detectors, wheels, suspension components, brake dust shields, telephones (including operation of any portable cellular phone from within the vehicle without using an externally-mounted antenna) or transceiver equipment (for instance, CBs, walkie-talkie, ham radio or similar accessories) may cause extensive damage to the vehicle, compromise its safety, interfere with the vehicle's electrical system or affect the validity of the BMW Limited Warranty. See your authorized BMW center for additional information. ◀



Maintenance, replacement, or repair of the emission control devices and systems may be performed by any automotive repair establishment or individual using any certified automotive part. ◀

The following applies only to vehicles owned and operated in the US.

REPORTING SAFETY DEFECTS

If you believe that your vehicle has a defect that could cause a crash or could cause injury or death, you should immediately inform the National Highway Traffic Safety Administration (NHTSA) in addition to notifying BMW of North America, Inc., P.O. Box 1227, Westwood, New Jersey 07675-1227, Telephone (201) 307-4000.

If NHTSA receives similar complaints, it may open an investigation, and if it finds that a safety defect exists in a group of vehicles, it may order a recall and remedy campaign. However, NHTSA cannot become involved in individual problems between you, your dealer, or BMW of North America, Inc.

To contact NHTSA, you may either call the Auto Safety Hotline toll-free at 1-800-424-9393 (or 366-0123 in Washington, D.C. area) or write to: NHTSA, U.S. Department of Transportation, Washington, D.C. 20590. You can also obtain other information about motor vehicle safety from the Hotline.



Overview

Controls and features

Operation, care
and maintenance

Owner service procedures

Advanced technology

Technical data

Index



Contents

Overview

- Cockpit 16
- Instrument cluster 18
- Indicator and warning lamps 20
- Multifunction steering wheel (MFL) 23
- Hazard warning flashers 24
- Warning triangle 24
- First-aid kit 24
- Refueling 25
- Fuel specifications 26
- Tire inflation pressure 26

Controls and features

- Locks and security systems:**
 - Keys 30
 - Electronic vehicle immobilizer 31
 - Central locking system 32
 - Opening and closing – from the outside 32
 - Using the key 32
 - Using the remote control 33
 - Opening and closing – from the inside 36
 - Luggage compartment lid 37
 - Luggage compartment 39
 - Alarm system 40
 - Electric power windows 42
 - Sliding/Tilt sunroof 43
- Adjustments:**
 - Seats 45
 - Steering wheel 48
 - Mirrors 49
 - Seat, mirror and steering wheel memory 50
 - Car Memory, Key Memory 52

Passenger safety systems:

- Safety belts 53
- Airbags 54
- Child restraints 58
- Child seat security 60
- Child-safety locks 60

Driving:

- Steering/Ignition lock 61
- Starting the engine 62
- Switching off the engine 62
- Parking brake 63
- Manual transmission 64
- Turn signal indicator/Headlamp flasher 64
- Washer/Wiper system/Rain sensor 65
- Rear window defroster 67
- Cruise control 67

Everything under control:

- Odometer, outside temperature display 69
- Tachometer 70
- Engine oil temperature gauge 70
- Fuel gauge 70
- Coolant temperature gauge 71
- Service Interval Display 71
- Check Control 72
- Onboard computer 74

- Controls and features**
- Technology for safety and driving convenience:**
 - Park Distance Control (PDC) 75
 - Dynamic Stability Control (DSC) 76
 - M Dynamic Driving Control 77
 - Tire Pressure Warning (RDW) 77
 - Lamps:**
 - Side lamps/Headlamps 79
 - Instrument rheostat 79
 - High beams/Parking lamps 80
 - Fog lamps 80
 - Interior lamps 80
 - Reading lamps 81
 - Controlling the climate for pleasant driving:**
 - Automatic climate control 82
 - Integrated rear center console 88
 - Seat heating 90
 - Roller sun blind 90
 - Independent ventilation system 90
 - Cabin convenience:**
 - BMW Universal Transmitter 91
 - Integrated rear-seat equipment 94
 - Glove compartment 95
 - Storage compartments 96
 - Cellular phone 96
 - Beverage holder 96
 - Ashtray, front 97
 - Cigarette lighter 98
 - Ashtray, rear 98
 - Loading and transporting cargo:**
 - Through-loading system 99
 - Ski bag 100
 - Cargo loading 102
 - Roof-mounted luggage rack 103
- Operation, care and maintenance**
- Special operating instructions:**
 - Break-in procedures 106
 - Driving notes 107
 - Catalytic converter 108
 - Antilock Brake System (ABS) 109
 - Disc brakes 111
 - Brake system 112
 - Winter operation 113
 - Power steering 115
 - Cellular phones 115
 - Radio reception 115
 - Wheels and tires:**
 - Tire inflation pressure 116
 - Tire condition 116
 - Tire replacement 118
 - Tire rotation 118
 - Wheel and tire combinations 119
 - Winter tires 120
 - Snow chains 121
 - Approved wheel and tire specifications 122

Contents

Operation, care and maintenance

Under the hood:

- Hood [123](#)
- Engine compartment [124](#)
- Washer fluids [126](#)
- Washer nozzles [126](#)
- Engine oil [127](#)
- Coolant [129](#)
- Brake fluid [130](#)
- Vehicle Identification Number [131](#)

Care and maintenance:

- The BMW Maintenance System [132](#)
- Caring for your car [133](#)
- Airbags [139](#)
- Vehicle storage [139](#)

Laws and regulations:

- Technical modifications [140](#)
- OBD interface socket [141](#)

Owner service procedures

Replacement procedures:

- Onboard tool kit [144](#)
- Windshield wiper blades [144](#)
- Lamps and bulbs [145](#)
- Repairing a flat tire [150](#)
- Battery [153](#)
- Fuses [156](#)

In case of electrical malfunction:

- Fuel filler door [157](#)
- Sliding/Tilt sunroof [157](#)

Assistance, giving and receiving:

- Jump-starting [158](#)
- Towing the vehicle [159](#)

Advanced technology

- Airbags [164](#)
- Radio reception [164](#)
- BMW active seat [165](#)
- Dynamic Stability Control (DSC) [166](#)
- Safety belt tensioner [166](#)
- DSP sound system [166](#)
- Interior rearview mirror with automatic dimmer [167](#)
- Integrated rear suspension [167](#)
- Latent heat storage system [168](#)
- Rain sensor [168](#)
- Xenon lamps [169](#)

Technical data

- Engine data [172](#)
- Dimensions [173](#)
- Weights [174](#)
- Capacities [175](#)
- Electrical system [176](#)
- Drive belts [176](#)

Index

- Everything from A to Z [180](#)
- Owner service procedures [186](#)





Cockpit 16
 Instrument cluster 18
 Indicator and warning lamps 20
 Multifunction steering wheel
 (MFL) 23
 Hazard warning flashers 24
 Warning triangle 24
 First-aid kit 24
 Refueling 25
 Fuel specifications 26
 Tire inflation pressure 26

Overview

Controls and features

Operation, care and maintenance

Owner service procedures

Advanced technology

Technical data

Index

16 Cockpit

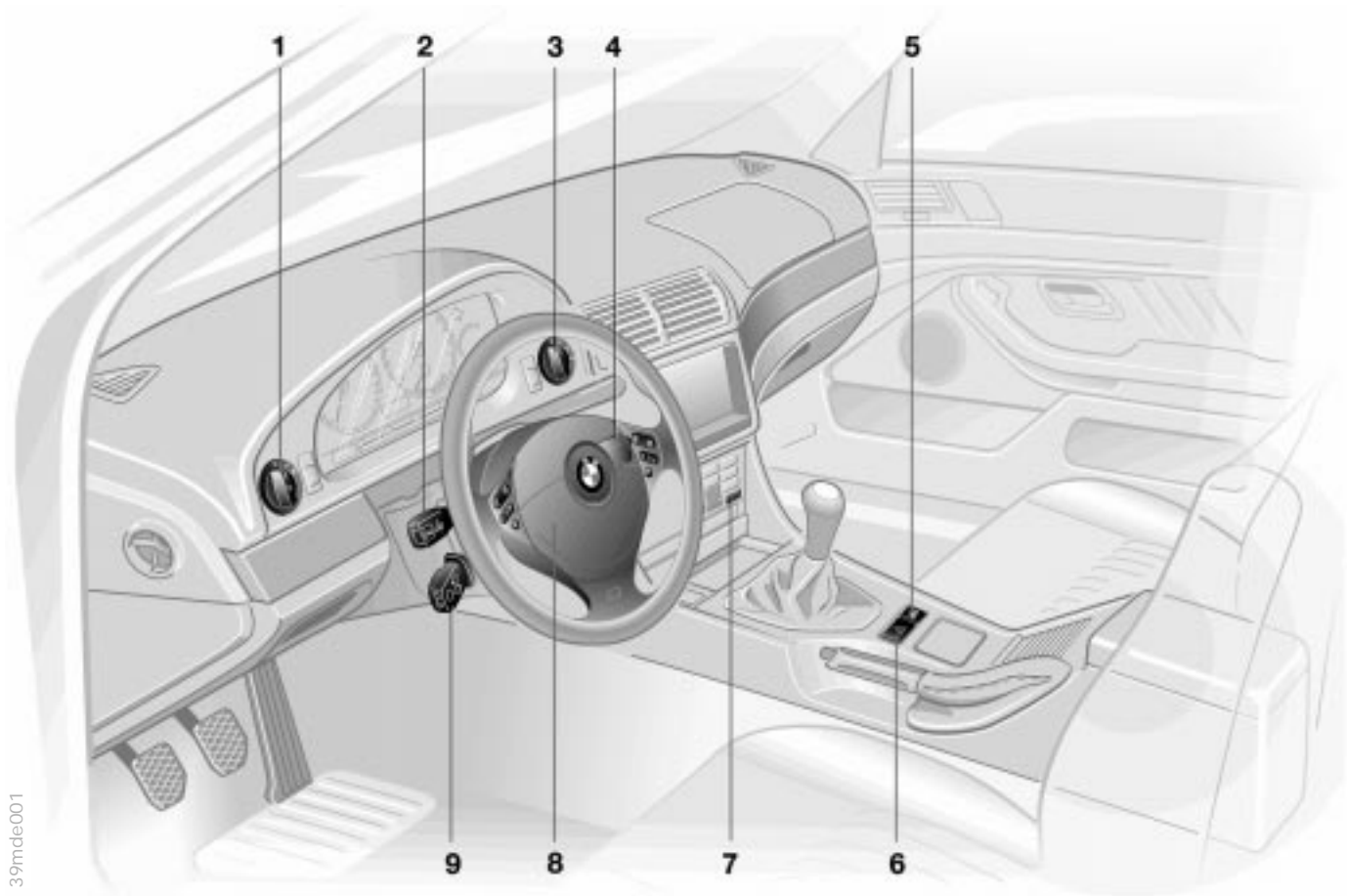

- 1 Side lamps/Low beams [79](#)
- 2 ▷ Turn signal indicator [64](#)
 - ▷ Parking lamp [80](#)
 - ▷ High beam [80](#)
 - ▷ Headlamp flasher [64](#)
 - ▷ Onboard computer [74](#)
- 3 Fog lamps [80](#)
- 4 Wiper/Washer system [65](#)
- 5 Central locking system [32](#)
- 6 Hazard warning flashers [24](#)
- 7 Rear window defroster [67](#)
- 8 Horn: The entire surface
- 9 Electronic steering wheel adjustment [48](#)

18 Instrument cluster

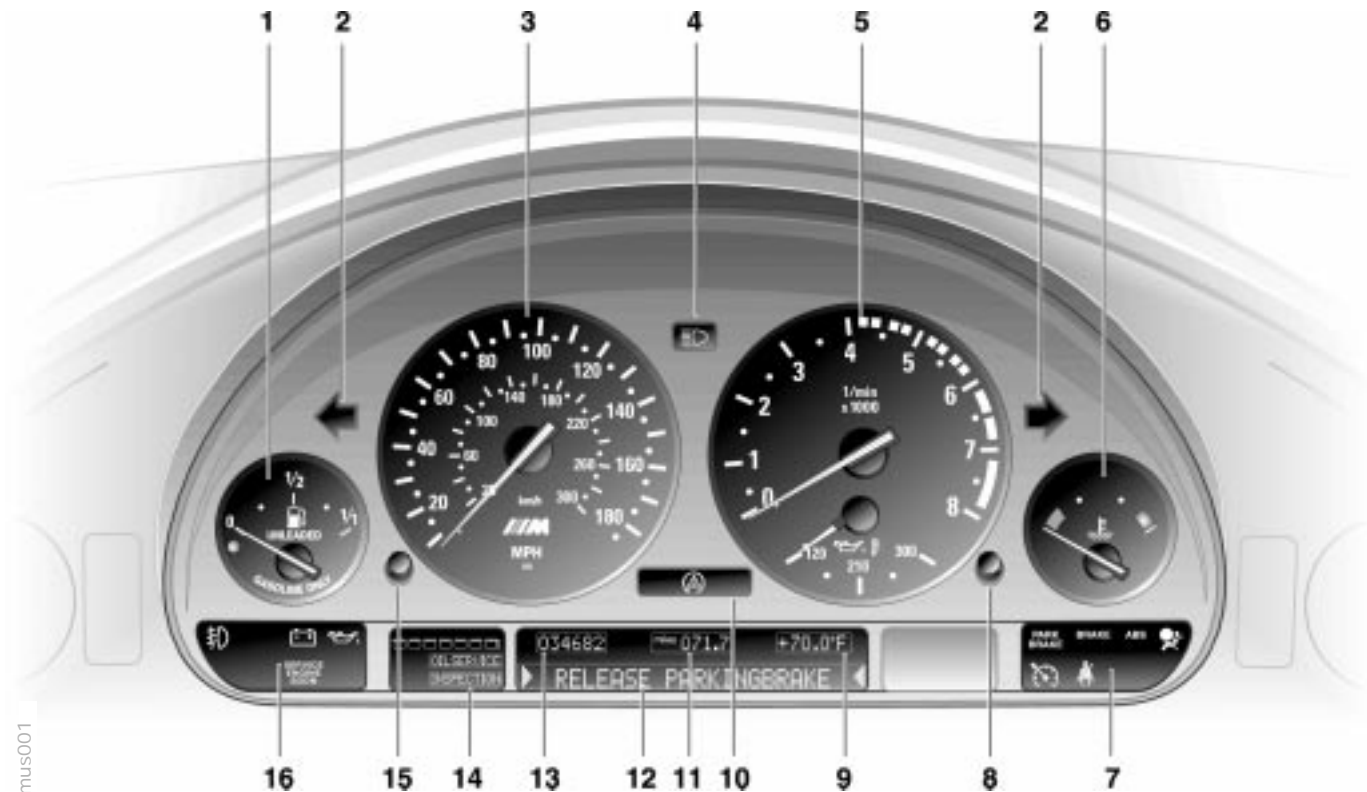

Instrument cluster

- 1 Fuel gauge with indicator lamp for fuel reserve [70](#)
- 2 Indicator lamp for turn signals [22](#)
- 3 Speedometer
- 4 Indicator lamp for high beams [22](#)
- 5 Tachometer and engine oil temperature gauge [70](#)
- 6 Engine coolant temperature gauge [71](#)
- 7 Indicator and warning lamps (clockwise) for
 - ▷ Parking brake [21](#)
 - ▷ Brake hydraulic system/Dynamic Brake Control (DBC) [20, 21](#)
 - ▷ Antilock Brake System (ABS) [21](#)
 - ▷ Airbags [21](#)
 - ▷ Please fasten safety belts [21](#)
 - ▷ Cruise control* [22](#)
- 8 CHECK button [72](#)
- 9 Outside temperature display [69](#)
- 10 Indicator lamp for Dynamic Stability Control (DSC) [21](#)
- 11 Trip odometer [69](#)
- 12 Indicator for
 - ▷ Check Control [72](#)
 - ▷ Onboard computer: refer to the Radio Owner's Manual
 - ▷ Radio and cellular telephone: refer to the separate Owner's Manual
- 13 Odometer [69](#)
- 14 Service Interval Display [71](#)
- 15 Trip odometer, reset to zero [69](#)
- 16 Indicator and warning lamps (clockwise) for
 - ▷ Fog lamps [22](#)
 - ▷ Battery charge current [20](#)
 - ▷ Engine oil pressure [20](#)
 - ▷ CHECK ENGINE lamp [21](#)



You can display the outside temperature and distance driven in different units of measurement. ◀

Technology that monitors itself

Many of the systems of your BMW monitor themselves automatically, both during engine starts and while you are driving. Indicator and warning lamps that are identified by "●" are tested for proper functioning whenever the ignition key is turned. They light up once for different periods of time.

If a fault should occur in one of these systems, the corresponding lamp does not go out after the engine is started or it lights up while the vehicle is moving. You will see how to react to this in the following section.

Red: Stop immediately



Battery charge current ●
The battery is no longer being charged. There is a malfunction of the alternator drive belt or in the charging circuit of the alternator. Please contact the nearest BMW center.



If the drive belt is defective, do not continue driving. The engine could be damaged due to overheating. If the drive belt is defective, increased steering effort is also required. ◀



Engine oil pressure ●
If the message "STOP! ENGINE OIL PRESSURE" appears in the Check Control: Stop the vehicle and switch off the engine immediately. Check the engine oil level; top up as required. If the oil level is correct: Please contact the nearest BMW center.



Do not continue driving. The engine could be damaged because of inadequate lubrication. ◀



Brake hydraulic system ●
Have the brake fluid level checked. Before continuing your journey, be sure to read the notes on pages [112](#) and [130](#).

The indicator lamp comes on together with the "Check brake pads" message in the Check Control.



Warning lamp, brake hydraulic system for Canadian models.

Indicator and warning lamps

Red: An important reminder



Parking brake ●
Comes on when you engage the parking brake.

For additional information: Refer to page [63](#)



Parking brake warning lamp for Canadian models.



Please fasten safety belts ●
An acoustical signal is sounded and a message appears in the Check Control for 4 to 8 seconds. The acoustical signal ends when the belt is fastened.

For additional information on safety belts: Refer to page [53](#)



Airbags ●
Please have the system inspected by your BMW center.

For additional information: Refer to page [54](#), [164](#)

Yellow: Check as soon as possible



Antilock Brake System (ABS) ●
ABS has been deactivated in response to a system malfunction. Conventional braking efficiency is available without limitations. Please have the system inspected by your BMW center.

For additional information: Refer to page [109](#)



ABS warning lamp for Canadian models.



Dynamic Stability Control (DSC) ●
DSC has been switched off or has been deactivated because of a malfunction. In the event of a malfunction, have the system checked by your BMW center.

For additional information: Refer to page [76](#)



Dynamic Brake Control (DBC)* ●
Fault in the DBC system. Conventional braking efficiency is available without limitations. For additional information: Refer to page [112](#)



Warning lamp, Dynamic Brake Control (DBC)* for Canadian models



Service engine soon ●
If the indicator lights up either continuously or intermittently, this indicates a fault in the emissions-related electronic systems. Although the vehicle remains operational, you should have the systems checked by you BMW center at the earliest possible opportunity. For additional information on the OBD interface socket: Refer to page [141](#)



Engine Management warning lamp for Canadian models

22 Indicator and warning lamps

Green: For your information



Turn signal indicator

Flashes when the turn signals are in operation. Rapid flashing means there is a fault in the system.

For additional information: Refer to page [64](#)



Cruise control

Comes on when the cruise control is activated: available for operation via the multifunction steering wheel.

For additional information: Refer to page [67](#)



Fog lamps

Lights up whenever you switch on the fog lamps.

For additional information: Refer to page [80](#)

Blue: For your information



High beam

Lights up when the high beams are on or the headlamp flasher is actuated.

For additional information: Refer to pages [64](#) and [80](#)

Multifunction steering wheel (MFL)

The controls integrated in the multifunction steering wheel (MFL) are provided so that you can operate a number of accessories quickly and without being distracted from traffic conditions. You may operate:

- ▷ certain radio, CD and cassette play functions
- ▷ the cruise control and
- ▷ selected cellular phone functions.

 In order to operate a system via the MFL, the corresponding system controls must be activated. ◀

The illustration shows the maximum possible number of controls, corresponding to a full range of optional equipment. Refer to the individual accessory manuals for more detailed descriptions.



- | | |
|---|--|
| <p>1 Cellular phone: Receive a call, start dialing, terminate a call</p> <p>2 Radio/Telephone: Volume</p> <p>3 Radio/Telephone: Scan forward/backward or scan station keys or scroll in the phone listings. Forward and return run for CD and cassette play</p> <p>4 Horn: The entire surface</p> | <p>5 Cruise control: Resume stored setting</p> <p>6 Cruise control: Activate/Interrupt/Cancel</p> <p>7 Cruise control: Store and accelerate (+); decelerate and store (-)</p> <p>8 Radio/Telephone: Select</p> |
|---|--|

24 Hazard warning flashers



The button flashes intermittently when the hazard warning flashers are on.

To help you locate the switch in an emergency, the button is also illuminated whenever the car lamps are on.

Warning triangle*

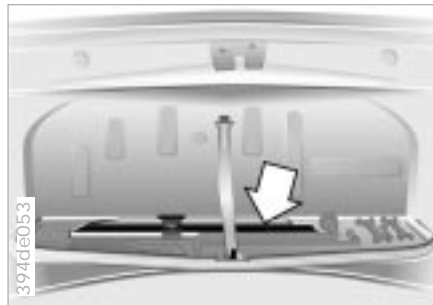

The hazard warning triangle is readily accessible. It is stored in the container for the onboard tool kit mounted in the luggage compartment lid.

To open the container, loosen the wing nut(s).



Comply with legal requirements that cover the availability of a hazard warning triangle in the car. ◀

First-aid kit*



Under the front passenger's seat.

To remove: Lift the release lever on the front (arrow) and pull the first-aid kit forward out of its support.

To store: Position the back of the kit into the support, then push back until the lever engages.



Some of the articles in the first-aid kit may be used within a limited time only. For this reason, check the contents of the kit regularly. Replace any items whose expiration dates have passed. These items are available in any drugstore or pharmacy. Comply with legal requirements that cover availability of a first-aid kit in the car. ◀



Fuel filler door

 Before filling the tank, shut off the engine. If you do not, fuel cannot be filled into the tank and the "Check Engine" warning lamp will come on. ◀

To open the filler door, press on the front edge.

To unlock the fuel filler door if the central locking system malfunctions, refer to page [157](#).

 When handling fuels, comply with all of the applicable safety precautions and regulations posted at the filling station. Never carry spare fuel containers in your vehicle. Whether empty or full, these containers can leak, cause an explosion, or lead to fire in the event of a collision. ◀



Simple and environmentally friendly

 Open the filler cap carefully to prevent fuel from spraying out. Fuel spray may cause injury. Do not top off. Topping off may cause fuel spillage. ◀

Keep the filler cap in the bracket attached to the fuel filler door.

When refueling, insert the filler nozzle completely into the filler pipe. Pulling the nozzle out of the pipe during refueling

- ▷ results in premature pump shutoff
- ▷ and will reduce the effect of the vapor recovery system on the pump.

 Close the fuel cap carefully after refueling. A loose or missing cap will activate the Check Engine lamp. ◀

26 Fuel specifications

Use unleaded gasoline only.

Minimum octane rating: 91 AKI.

BMW engines are equipped with knock sensors and will adapt automatically to different octane ratings, provided that the minimum octane requirement (89 AKI) is met.

Fuels with higher octane ratings will provide enhanced performance and lower fuel consumption, while the use of fuels with low octane ratings will have the opposite effect.

 Do not use leaded fuels. The use of leaded fuels will cause permanent damage to the system's oxygen sensor and the catalytic converter. ◀

AKI = Anti Knock Index

Tire inflation pressure



The inflation pressures are indicated on a label attached to the B-pillar behind the driver's door (visible with door open).

Check tire pressures

All pressure specifications are indicated in psi (kilopascal) for tires at ambient temperature (refer also to the next page).

 Following a correction of the tire inflation pressure, reactivate the Tire Pressure Warning (RDW) system. Refer to page [77](#). ◀

 Check tire inflation pressures regularly – at least every two weeks and before beginning a longer trip. Incorrect tire pressure can otherwise lead to tire damage and accidents. ◀

Tire inflation pressure

Comply with tire approval specifications

The inflation pressures in the table apply to tires from BMW-approved manufacturers. Your BMW center is familiar with these pressures. Higher pressures may be specified for tires from other manufacturers. You will find a list of approved tire sizes beginning on page [122](#).

Your vehicle is equipped with tires which not only meet US standards, but also European standards. We recommend the exclusive use of BMW-approved tires.

BMW	Tires All pressure specifications in the table are indicated in psi (kilopascal) with cold tires (cold = ambient temperature)				
	245/40 ZR 18	35 (240)	-	46 (320)	-
M5	275/35 ZR 18	-	38 (260)	-	51 (350)
	235/45 R 17 94 H M+S	35 (240)	38 (260)	39 (270)	46 (320)

**Locks and security systems:**

Keys 30

Electronic vehicle
immobilizer 31

Central locking system 32

Opening and closing – from the
outside 32

Using the key 32

Using the remote control 33

Opening and closing – from the
inside 36

Luggage compartment lid 37

Luggage compartment 39

Alarm system 40

Electric power windows 42

Sliding/Tilt sunroof 43

Adjustments:

Seats 45

Steering wheel 48

Mirrors 49

Seat, mirror and steering wheel
memory 50

Car Memory, Key Memory 52

Passenger safety systems:

Safety belts 53

Airbags 54

Child restraints 58

Child seat security 60

Child-safety locks 60

Driving:

- Steering/Ignition lock 61
- Starting the engine 62
- Switching off the engine 62
- Parking brake 63
- Manual transmission 64
- Turn signal indicator/Headlamp flasher 64
- Washer/Wiper system/Rain sensor 65
- Rear window defroster 67
- Cruise control 67

Everything under control:

- Odometer, outside temperature display 69
- Tachometer 70
- Engine oil temperature gauge 70
- Fuel gauge 70
- Coolant temperature gauge 71
- Service Interval Display 71
- Check Control 72
- Onboard computer 74

Technology for safety and convenience:

- Park Distance Control (PDC) 75
- Dynamic Stability Control (DSC) 76
- M Dynamic Driving Control 77
- Tire Pressure Warning (RDW) 77

Lamps:

- Side lamps/Headlamps 79
- Instrument rheostat 79
- High beams/Parking lamps 80
- Fog lamps 80
- Interior lamps 80
- Reading lamps 81

Controlling the climate for pleasant driving:

- Automatic climate control 82
- Integrated rear center console 88
- Seat heating 90
- Roller sun blind 90
- Independent ventilation system 90

Cabin convenience:

- BMW Universal Transmitter 91
- Integrated rear-seat equipment 94
- Glove compartment 95
- Storage compartments 96
- Cellular phone 96
- Beverage holder 96
- Ashtray, front 97
- Cigarette lighter 98
- Ashtray, rear 98

Loading and transporting:

- Through-loading system 99
- Ski bag 100
- Cargo loading 102
- Roof-mounted luggage rack 103

Overview**Controls and features****Operation, care and maintenance****Owner service procedures****Advanced technology****Technical data****Index**

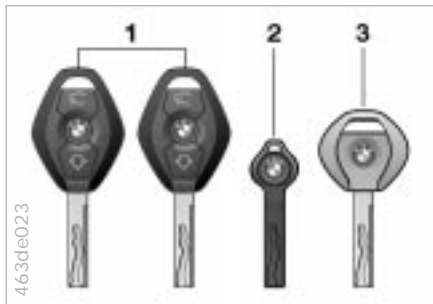

1 The master keys with remote control determine the functions of the Key Memory. Refer to page [52](#).

 There is an extended-life battery in every master key which is charged automatically in the steering lock as you drive.

For this reason, if you have a master key that is otherwise not used, use that key approximately once every year while driving for an extended period. This will charge the battery. Refer also to page [33](#). ◀

2 Spare key for storage in a safe place, such as in your wallet. This key is not intended for continuous use.

3 Door and ignition key

The lock for the glove compartment cannot be operated with this key. This is recommended for valet parking, for instance.

Replacement keys

Replacement keys are available exclusively through your BMW center. Your BMW center is obligated to ensure that a person requesting a key is authorized to do so since the keys belong to a security system (refer to "Electronic vehicle immobilizer" on page [31](#)).

 Whenever you receive a new replacement key, turn that key to position 2 in the ignition lock once (ignition switched on) and then back. This allows the electronic vehicle immobilizer to "learn" the new key. ◀

Electronic vehicle immobilizer



The key to security

Your BMW is equipped with a passive anti-theft system. This electronic immobilization system is designed to reduce the susceptibility of the vehicle to theft by making it impossible to start the engine using any means other than the special keys furnished with the vehicle. Your BMW center can cancel the electronic system authorization for individual keys (in the event of loss, for instance). A deactivated key can no longer be used to start the engine.

How the electronics work

At the heart of this system is an electronic chip that is integrated into the key. The lock mechanism itself is actually a dual-function device, simultaneously serving as a communications interface designed to allow the security system to maintain a continuous stream of variable, vehicle-specific signals with the electronic circuitry in the key. The system will not release the ignition, fuel injection and starter unless it recognizes an "authorized" key.

 Force applied to the key can damage the integrated electronic circuitry. A damaged key can no longer be used to start the engine. ◀

The concept

The central locking system is ready for operation when both front doors are closed. The system engages and releases the locks on the

- ▷ doors
- ▷ luggage compartment lid
- ▷ fuel filler door.

The central locking system can be operated

- ▷ from outside via the door lock and using the remote control
- ▷ from inside by pressing a button.

The fuel filler door is not locked when you open the vehicle from the inside (refer to page 36). The alarm system is automatically armed whenever you activate the central locking system from outside of the vehicle. Both the door locks and release handles remain locked. The alarm system is also activated or deactivated.

If locked from inside, the central locking system unlocks automatically (only those doors which were not locked separately with the safety lock buttons) in the event of an accident. Refer to page 36. In addition, the hazard warning flashers and interior lamps come on.

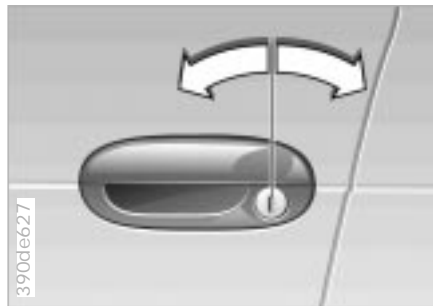
**Using the key**

One turn of the key in the driver's door lock unlocks the driver's door only. Turning the key a second time unlocks all of the remaining doors, the luggage compartment lid and the fuel filler door.



You can have a confirmation message set to inform you that the car has been properly locked (in preparation). ◀



When a door is opened, the interior lamps are switched on. They are switched off automatically. ◀

You will find additional information on the alarm system on page 40.

Convenience operation

You can also operate the windows and sliding/tilt sunroof via the door lock.

- ▷ To open: With the door closed, turn the key to the "Unlock" position and hold it.
- ▷ To close: With the door closed, turn the key to the "Lock" position and hold it.



Watch during the closing process to be sure that no one is inadvertently injured. Releasing the key stops the operation. ◀

Manual operation

(in the event of an electrical failure)

Turn the key to the extreme left or right to unlock/lock the door.

Opening and closing – from the outside

Using the remote control

The remote control makes opening and locking the doors of your vehicle very convenient. Furthermore, it provides three additional functions that can only be executed by means of the remote control:

- ▷ To switch on interior lamps
With this function, you can also "search for" your vehicle – when parked in an underground garage, for instance.
- ▷ To open the luggage compartment lid
The luggage compartment lid will open slightly, regardless of whether the lid was previously locked or unlocked.
- ▷ Panic Mode
In case of danger, you can trigger an alarm.

When the vehicle is unlocked or locked, the anti-theft system is simultaneously deactivated/activated, the alarm system is disarmed/armed and the interior lamps are switched on/off.

 You can have a confirmation message set to inform you that the car has been properly locked (in preparation). ◀



Master keys

Keys with remote control are master keys. Refer to page 30.

 Children might be able to lock the doors from the inside. For this reason, always take the vehicle's keys with you so that the vehicle can be opened again from the outside at any time. ◀

 Master keys that are used repeatedly are always ready for operation since the battery in the key is charged automatically in the steering lock as you drive.

If it is no longer possible to unlock the vehicle via the remote control, the battery is discharged. Use this key while driving for an extended period in order to charge the battery. Refer also to page 30.

To prevent unauthorized use of the remote control, surrender only the door and ignition key 3 or the spare key 2 (refer to page 30) when leaving the vehicle for valet parking, for example. In the event of a system malfunction, please contact your BMW center. You can also obtain replacement keys there. ◀

34 Opening and closing – from the outside



Unlocking and convenience opening mode

To unlock the driver's door: Press button 1.

Press the button once to unlock the driver's door only; press a second time to unlock all remaining doors as well as the luggage compartment and fuel filler door.

Convenience opening mode: Press and hold button 1. The windows and the sliding/tilt sunroof are then opened.



To lock and secure

Press button 2.



Deactivate the tilt sensor alarm system and interior motion sensor

Press button 2 a second time immediately after locking. For additional information: Refer to page [41](#).

To switch on the interior lamps

After locking the car, press button 2 a second time.

Opening and closing – from the outside



Luggage compartment lid open – Panic Mode

Open the luggage compartment lid:
Press button 3.

The luggage compartment lid will open slightly, regardless of whether it was previously locked or unlocked.

 Before and after a trip, be sure that the luggage compartment lid did not open unintentionally. ◀

Panic Mode: By pressing and holding button 3 for two to five seconds, you can trigger the alarm system if there is an impending danger (the system must be armed).

The alarm is deactivated by pressing button 1.

Non-BMW systems

The remote control system's functioning may be affected by other units or equipment operating in the immediate vicinity of your car.

If this should occur, you can unlock and lock the vehicle via the door lock with a master key.

For US owners only

The transmitter and receiver units comply with part 15 of the FCC (Federal Communications Commission) regulations. Operation is governed by the following:

FCC ID: LX8EWS
 LX8FZVS
 LX8FZVE

Compliance statement:

This device complies with part 15 of the FCC Rules. Operation is subject to the following two conditions:

- ▷ This device may not cause harmful interference, and
- ▷ this device must accept any interference received, including interference that may cause undesired operation.

 Any unauthorized modifications or changes to these devices could void the user's authority to operate this equipment. ◀

36 Opening and closing – from the inside



Use this button to operate the central locking system when the front doors are closed. The doors and luggage compartment lid are unlocked or locked only. The antitheft alarm system is not activated. Also, the fuel filler door remains unlocked to allow refueling.

 If you desire, the central locking system will secure the locks as soon as you start to drive. This can be adjusted to be key-specific. ◀



If only the driver's door was unlocked from the outside and you press the button

- ▷ all other doors, the luggage compartment lid and the fuel filler door will be unlocked if the driver's door is open
- ▷ the driver's door will be locked again if it is closed. ◀

To unlock and open the doors

- ▷ Either unlock the doors together with the button for the central locking system and then pull each of the release handles above the armrests or
- ▷ pull the release handle for each door twice: The first pull unlocks the door, and the second one opens it.



Doors locked from outside can be opened from inside by first pressing the button and then pulling the release handle twice. ◀

To engage the locks

- ▷ Use the central locking button to lock all of the doors simultaneously, or
- ▷ press down the individual door lock buttons. The fuel filler door remains then unlocked. As an added design feature to prevent the driver from being inadvertently locked out of the vehicle, the driver's door lock button will not engage as long as the door is open.



When the vehicle is moving, do not lock the doors with the safety lock buttons. Doors locked in this manner would not open automatically in the event of an accident. Children might be able to lock the doors from the inside. For this reason, always take the vehicle's keys with you so that the vehicle can be opened again from the outside at any time. ◀

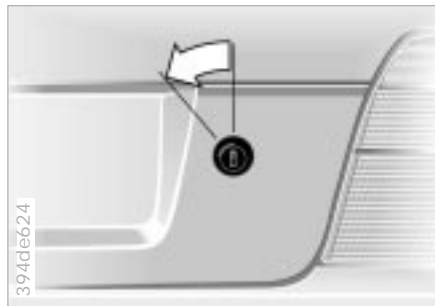

The lock

Only the master key (refer to page 30) fits in the lock of the luggage compartment.

Opening separately

Turn the master key to the left in the luggage compartment lock clear to the stop – the luggage compartment lid will open slightly.

The luggage compartment is locked again as soon as you close the lid.

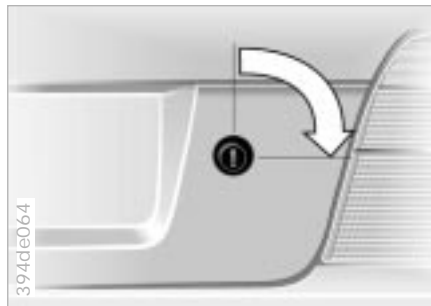

Securing separately

Turn the master key to the right past the resistance point and then pull it out in the horizontal position.

This locks the luggage compartment lid and disconnects it from the central locking system. This feature can be used to prevent unauthorized access to the luggage compartment when you surrender the door and ignition key (refer to page 30) for valet parking, for instance.

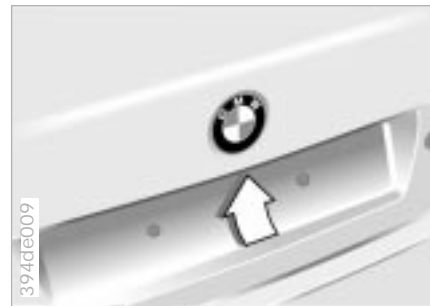

To open from outside

Press the button (arrow): The luggage compartment lid opens slightly.

The luggage compartment is lighted when the luggage compartment lid is opened.

Manual operation

(in the event of an electrical failure)

Turn the master key to the left in the luggage compartment lock clear to the stop – the luggage compartment lid will open slightly.

The luggage compartment is locked again as soon as you close the lid.

38 Luggage compartment lid



Opening from inside the car

Provided the luggage compartment has not been locked separately, you can use this button to open it when the vehicle is stationary.



To close

The handle recess (arrow) next to the lock mechanism is designed to assist you in closing the luggage compartment lid.

 Operate the vehicle only when the luggage compartment lid is completely closed. Otherwise, exhaust fumes could penetrate the interior of the vehicle. Should it be absolutely necessary to operate the vehicle with the luggage compartment lid open:

- ▷ Close all windows. Shut the sliding/tilt sunroof.
- ▷ Increase the air supply of the automatic climate control to a high level. Refer to page 85. ◀

Luggage compartment

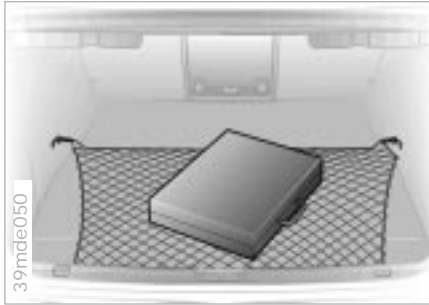

Luggage net

Use the luggage net to secure smaller items of luggage.

If you place objects on the luggage net, this helps to prevent them from moving.

The lashing eyes located at the corners of the luggage compartment provide you with a convenient means of attaching draw straps* for securing suitcases and luggage.

Refer also to "Cargo loading" on page [102](#).

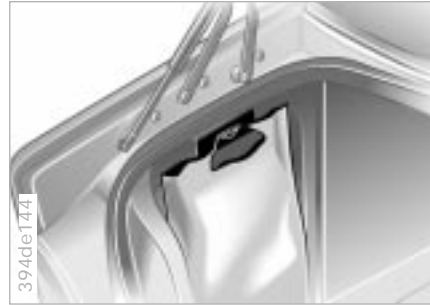

Hanger*

You will find a hanger on the left-hand side of the luggage compartment for fastening shopping bags, packages or other items.

The concept

The vehicle alarm system responds:

- ▷ When a door, the hood or the luggage compartment lid is opened.
- ▷ To movement inside the vehicle (interior motion sensor).
- ▷ Changing the vehicle's tilt if someone attempts to steal the wheels or tow the vehicle.
- ▷ To an interruption in battery voltage.

The system responds to unauthorized vehicle entry and attempted theft by simultaneously activating the following:

- ▷ Sounding an acoustical alarm for 30 seconds.
- ▷ The hazard warning flashers are activated for approx. five minutes.
- ▷ The high beams flash on and off in the same rhythm.

To activate and deactivate the alarm system

When the vehicle is locked or unlocked with the key or the remote control, the alarm system is also simultaneously armed or disarmed.

The interior motion sensor is activated approx. 30 seconds after you have finished locking the car.

The system indicates that it has been correctly armed by switching on the hazard warning flashers for a single cycle and by emitting an acoustical signal.



You can have various confirmation messages set to inform you that the alarm system has been armed or disarmed (in preparation). ◀

You can still open the luggage compartment after the system has been armed by pressing button 3 of the remote control (refer to page 40). When you close the luggage compartment, the lid is secured again.

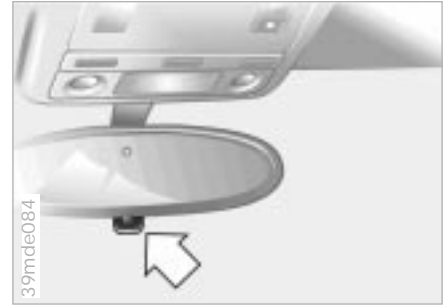

Indicator lamp displays

- ▷ The indicator lamp below the interior rearview mirror flashes continuously: The system is armed.
- ▷ The indicator lamp flashes when it is armed: A door (or doors), the hood, luggage compartment lid or rear window is not completely closed. Even if you do not close the indicated area, the system begins to monitor the remaining areas, and the indicator lamp flashes continuously after 10 seconds. However, the interior motion sensor is not activated.
- ▷ If the indicator lamp goes out when the system is disarmed: No manipulation or attempted intrusions have been detected in the period since the system was armed.

Alarm system

- ▷ If the indicator lamp flashes for 10 seconds when the system is disarmed: An attempted entry has been detected in the period since the system was armed.

Following triggering of an alarm, the indicator lamp will flash continuously.

Avoiding unintentional alarms

The tilt alarm sensor and interior motion sensor may be switched off at the same time. You can do this to prevent a false alarm from being triggered (in garages with elevator ramps, for instance), or when the vehicle is transported by trailer or train:

Actuate the lock (= arm the system) twice; in other words, press button 2 of the remote control twice in succession (refer to page 34). You may also actuate the locks twice with the key (refer to page 34).

The indicator lamp lights up briefly and then flashes continuously. The tilt alarm sensor and the interior motion sensor are deactivated as long as the system is armed.



Interior motion sensor

The illustration depicts the transmitter and receiver of the interior motion sensor.

In order for the interior motion sensor to function properly, the windows and sliding/tilt sunroof must be completely closed.

However, you should switch off the interior motion sensor (see previous column under the heading "Avoiding unintentional alarms") if you wish to leave the windows or sliding/tilt sunroof open.

42 Electric power windows



Open and close the windows

In ignition key position 1 and 2:

- ▷ Depress the rocker switch until you feel resistance:
The window continues to move as long as you maintain pressure on the switch.
- ▷ Press the rocker switch beyond the resistance point:
The window moves automatically. Press the switch a second time to stop the window.

After the ignition has been switched off:

- ▷ You can still operate the power windows as long as neither of the front doors has been opened. To open a window, press the switch beyond the resistance point.

 Remove the key from the ignition key and close the doors when you leave the vehicle so that children cannot operate the power windows and possibly injure themselves. ◀

For convenience operation via the door lock or remote control, refer to page [32](#) or [34](#).

Safety feature

A contact strip is located on the inside upper frame of each of the windows. If pressure is exerted against this contact strip while a window is being raised, the system will respond by stopping the window and then retracting it a small distance.

 Despite this safety feature, be extremely careful to ensure that the closing path of the window is not obstructed. Otherwise, an object might not touch the contact strip in some situations (very thin objects, for instance). You can disable this safety feature by pressing the switch beyond the pressure point and holding it. Because the power windows are sealed at high pressure to prevent wind noise when closed, a powerful motor is required for efficient closing. When closing the windows, always be sure that they are not obstructed in any way. Unsupervised use of these systems can result in serious personal injury. Remove the ignition key to deactivate the electric power windows whenever you leave the car. Never leave the keys in the car with unsupervised children. Never place anything that could obstruct the driver's vision on or next to the windows. ◀



Safety switch

You can use the safety switch to deactivate the rear power window switches (with children in the rear seats, for instance).

 Press the safety switch whenever children are riding in the rear of the vehicle. Careless use of the power windows can lead to injury. ◀

 To prevent injuries, exercise care when closing the sliding/tilt sunroof and keep it in your field of vision until it is shut.

Before leaving the car, switch off the electric sunroof mechanism by taking out the ignition key. Do not leave children unattended in the vehicle with access to vehicle keys. Use of the key can result in starting of the engine and operation of vehicle systems such as the power sunroof. Unsupervised use of these systems can result in serious personal injury. ◀

You can avoid pressure or drafts in the passenger compartment when the sunroof is open or lifted by opening the air vents in the dashboard and increasing the air supply as required. Refer to page 85.

If the sunroof is completely open, air disturbances may be caused in the vehicle when you are driving at higher speeds. Close the roof as far as is necessary until this natural phenomenon ceases.

For convenience operation via the door lock or remote control, refer to page 32 or 34.

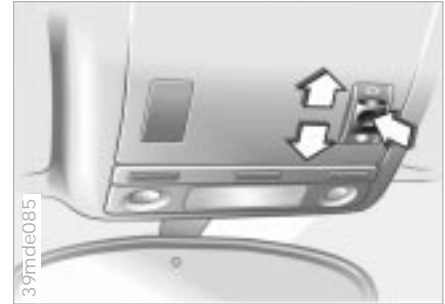

Lifting – Opening – Closing

With the ignition key in position 1 or higher, press the switch or slide it to the desired direction until you feel resistance.

When lifting, the headliner retracts several inches.

After the ignition has been switched off, you can still operate the sunroof as long as neither front door has been opened.

44 Sliding/Tilt sunroof*

Automatic* opening and closing

Press the switch past the resistance point briefly: The sunroof travels to either the fully-closed or fully-open position.

Other automatic operations are:

- ▷ With the sunroof open, press the switch briefly toward "Lift:"
The sunroof automatically extends to its fully raised position.
- ▷ With the sunroof raised, press the switch briefly toward "Open:"
The sunroof automatically extends to the "Open" position.

Pressing the switch again stops the motion immediately.

Safety feature

If the sliding/tilt sunroof encounters resistance at a point roughly past the middle of its travel when it is closing, the closing cycle is interrupted and the sunroof will open again slightly.



Despite this safety feature, be extremely careful to ensure that the closing path of the roof is not obstructed. Otherwise, triggering the closing-force limitation may not be ensured in some situations (with very thin objects, for instance). You can disable this safety feature by pressing the switch beyond the pressure point and holding it. ◀

Sliding/Tilt sunroof with glass moonroof*

The options and control procedures are essentially the same as those previously described for the sliding/tilt sunroof. In order to open the raised roof, press the control switch towards "Open" until the roof has reached the desired position.

The headliner insert slides back somewhat when you raise the sunroof. When the sunroof is opened, the headliner retracts with it. The headliner will then automatically remain in its retracted position, but can be repositioned as desired.



Power loss or malfunction

Following a power interruption (if the battery is disconnected, for instance), the sunroof can only be raised in some circumstances. To correct this situation:

- 1 Raise the sliding/tilt sunroof fully.
- 2 Press and hold the switch for approx. 20 seconds.

In the event of an electrical system malfunction, the sliding/tilt sunroof can be manually operated. Refer to page 157.

Seat adjustment

For maximum safety when adjusting the seat position, please observe the following:

⚠ Never try to adjust your seat while driving the vehicle. The seat could respond with unexpected movement, and the ensuing loss of vehicle control could lead to an accident.

Be sure that the safety belt remains firmly against your body at all times. In the event of a frontal impact, a loose lap belt could slide over your hips, leading to abdominal injury. In addition, the safety belt's restraint effectiveness is reduced if the belt is worn loosely. Never travel with the backrest reclined to an extreme angle (especially important for front passengers). Keep the backrest relatively upright to minimize the risk of sliding under the safety belt and sustaining injury in the event of a crash.

Do not move the seats to the rear when the vehicle is at an extreme angle (on garage ramps or steep slopes, for example). If you do so, the automatic safety belt height adjustment can be disengaged. ◀

BMW M Sports Seat



- 1 Tilt angle (driver seat only)
- 2 Backward/Forward adjustment
- 3 Cushion height
- 4 Backrest angle
- 5 Head restraint height.
Adjust the tilt angle of the head restraint manually by rotating it.

Correct sitting posture

To reduce strain on your spinal column, sit all the way back in the seat and rest your back fully against the backrest. The ideal sitting posture is achieved when your head is extended from your spine in a straight line.

For long-distance driving, you may wish to increase the angle of the backrest slightly to reduce muscular tension. You should always be able to reach the highest point on the steering wheel without straightening your arms.



Lumbar support

You can adjust the backrest's contour for additional support in the curvature of your spine's lumbar region.

The upper hips and spinal column receive supplementary support to help you maintain a relaxed, upright posture.

- ▷ Press the front/rear of switch: Increase/Decrease curvature.
- ▷ Press the upper/lower end of the switch: Curvature is shifted upward or downward.

 Comply with the adjustment instructions on page 45. Failure to do so could result in diminished personal safety. ◀



Thigh support

You can also adjust the thigh support to correspond with your personal comfort.



Head restraints

Adjust the angle of the front head restraint by rotating it forward or back.

To adjust the height of the rear head restraints: Adjust by pulling up or pushing down.

 Head restraints reduce the risk of spinal injury in the event of an accident.

Adjust the head restraint so that its center is approximately level with your ears.

Leave the center-rear head restraint in the fully-lowered position at all times. Extending it limits its function. ◀



This seat allows you to make additional adjustments with the power seat system (see under BMW M Sports Seat, page 45) for

- 1 Lumbar support
- 2 Shoulder support

Lumbar support

See under BMW M Sport Seat on page 46.



Shoulder support

Press the rocker switch to adjust the tilt angle of the shoulder support.

You can use the adjustable upper backrest for supplementary support in the shoulder region. This provides a relaxed driving position and helps relieve stress on the shoulder muscles.

To obtain the optimal shoulder support setting, we recommend:

Driver and front passenger:

- 1 Adjust the upper backrest section to its extreme rear position.
- 2 Adjust the seat to the optimal position as described above under "Correct sitting posture."
- 3 Bring the upper backrest section forward until your shoulders enjoy firm support.

Front passenger's seat adjustment for relaxed traveling:

- 1 Adjust the upper backrest section to its extreme rear position.
- 2 Increase the seat cushion tilt.
- 3 Tilt the backrest somewhat further.
- 4 Bring the upper backrest section forward.

 Make corrections in the forward-backward adjustment of the seat to ensure that the safety belt still fits firmly against your body. If you do not do this, the protection provided by the safety belt may be reduced. ◀

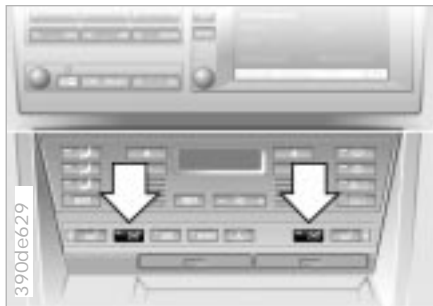

Active changes in the seat's surface help to avoid muscle cramps, pain in the spine's lumbar region and fatigue.

To activate the seat, press the button (arrow).

For additional details concerning the BMW active seat, please refer to the chapter describing "Advanced technology" on page [165](#).

Adjusting the steering wheel



The steering wheel can be moved in any of four directions. Adjust by moving the control lever in the desired direction.

 Do not adjust the steering wheel while the vehicle is moving. There is a risk of accident from unexpected movement. ◀

To store the steering wheel setting, refer to "Seat, mirror and steering wheel memory" on page [50](#).

Automatic steering wheel adjustment

In order to make it easier to get into and out of the car, the steering wheel automatically moves into the top position and returns to the driving (memory) position.

This automatic feature is controlled by the position of the ignition key and by the driver's door.



Your BMW center can adjust your vehicle's systems in such a manner that your personalized setting is automatically called up for the steering wheel position when you unlock the car with your personal remote control. ◀





Exterior mirrors

- 1 Switch for 4-way adjustment
- 2 Selection switch for changing between mirrors

You can also adjust the mirrors manually by pressing against the outer edges of their lenses.

To store the mirror settings: Refer to "Seat, mirror and steering wheel memory" on page [50](#).

 The mirror on the passenger's side features a lens with a more convex surface than the mirror installed on the driver's side. When estimating the distance between yourself and other traffic, bear in mind that the objects reflected in the mirror are closer than they appear. This means that estimations of the distance to following traffic should not be regarded as precise. ◀

 Your BMW center can adjust your vehicle's systems in such a manner that your personalized setting is automatically called up for the mirror position when you unlock the car with your personal remote control. ◀

Self-defrosting mirrors

Both mirrors are automatically defrosted with the ignition key in position 2.

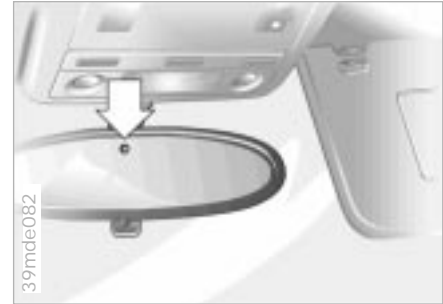

Interior rearview mirror, automatic dimming feature

By responding to the effects of ambient light and the glare from following traffic, this mirror dims automatically through an infinitely-variable range.

The mirror automatically reverts to its clear, undimmed setting whenever you engage reverse gear.

To ensure that the mirror continues to operate properly, keep the two photocells clean and unobstructed. One photocell (arrow) is in the mirror glass, while the other is offset somewhat on the opposite side of the mirror.

For an explanation of the electrochromic technology used in this mirror, refer to page [167](#).



Sun visors

The sun visors can be folded down toward the windshield or swiveled out against the side windows.

Lighted vanity mirror

Fold down the sun visor and slide the cover panel to the side as required.

The mirror lamps operate in ignition key positions 1 and 2.

Exterior mirrors with automatic dimming feature

Both outside rearview mirrors also dim automatically through an infinitely-variable range.

Seat, mirror and steering wheel memory



You can store and call up three different seat, exterior mirror and steering wheel positions. The illustration shows the buttons on the driver's door, for making these position adjustments.

The adjustment setting for the lumbar support is not saved in the memory.

To store

- 1 Turn the key to ignition key position 1 or 2.
- 2 Adjust the desired positions for the seat, door mirror and steering wheel.
- 3 Press the **MEMORY** button: The indicator lamp in the button lights up.
- 4 Press memory button 1, 2 or 3, as desired: The indicator lamp goes out.

To select a stored setting

Convenience function:

- 1 Open the driver's door after unlocking or put ignition key in position 1.
- 2 Briefly press memory button 1, 2 or 3, as desired.

Movement stops immediately when one of the seat-adjustment or memory buttons is activated during the adjustment process.

Safety function:

- 1 With the driver's door closed and ignition key either removed or in position 0 or 2.
- 2 Maintain pressure on desired memory button 1, 2 or 3 until the adjustment process is completed.

If you press the **MEMORY** button accidentally: Press the button a second time, the indicator lamp goes out.



Do not call up a position from the memory while the vehicle is moving. There is a risk of accident from unexpected movement of the seat or steering wheel. ◀

Seat, mirror and steering wheel memory



Your BMW center can adjust your vehicle's systems in such a manner that your personalized settings are automatically called up for the seat, mirror and steering wheel positions when you unlock the car with your personal remote control. ◀



If you make use of this setting mode, be sure that the footwell behind the driver's seat is unobstructed before unlocking the vehicle. Otherwise, persons or objects could be injured or damaged should the seat move backward. ◀



Passenger side exterior mirror tilt function

(automatic curb monitor)

- 1 Move the mirror selector switch (arrow) to the "driver's mirror" position.
- 2 When reverse gear is engaged, the passenger-side mirror tilts downward. This brings the area directly adjacent to the car (curbs, etc.) into the driver's field of vision as an assist during parking.

You can deactivate this automatic feature by setting the mirror selection switch to the "passenger side" position.



How the system functions

You have probably frequently wished that you could configure individual functions of your vehicle to reflect your own personal requirements. In developing this vehicle, BMW has "built in" a few options that, should you so desire, your BMW center can adjust for you.

There are settings related to the vehicle ("Car Memory") and settings related to individuals ("Key Memory"). You can configure two different basic settings for two different persons. The only requirement is that each person uses his or her own remote control key.

When your vehicle is unlocked with the remote control, the vehicle recognizes the individual user by means of a data exchange with the key, and makes adjustments accordingly.

In order for you to distinguish between different keys, colored decals are supplied together with the keys.

What the system can do

Your BMW center can provide you with details on the capabilities of the Car Memory and Key Memory systems.



You will see this symbol throughout the Owner's Manual. It is to remind you at appropriate places of the settings that are available to you. ◀

An example for Key Memory is the automatic adjustment of the driver's power seat with stored settings for the individual person when the vehicle is unlocked.

Safety belts



Fasten your safety belt before starting off.

To fasten: Make sure you hear the catch engage in the belt buckle.

To release: Press the red button in the buckle. Hold the belt and guide it back into its reel.

The shoulder belt anchor automatically adjusts to continue providing an optimum fit when you move the seat forward or back.

The two safety belt buckles that are integrated in the rear seat are for passengers sitting on the left and right. The belt buckle with the word "CENTER" (in the red button) is intended exclusively for a passenger sitting in the middle.

 For your safety, comply with the following instructions for wearing safety belts. If you do not, the safety belts may not be able to provide their maximum protection. The following information also applies to your passengers: Never allow more than one person to wear a single safety belt. Never allow infants or small children to ride in a passenger's lap.

Avoid twisting the belt while routing it firmly across the hips and shoulder. Do not allow the belt to rest against hard or fragile objects in your pockets. Never route the belt across your neck, do not run it across sharp edges and ensure that the belt does not become caught or jammed.

Be sure that the safety belt fits snugly against your body at all times, and avoid wearing clothing that prevents the belt from fitting properly. Pull on the belt periodically to readjust the tension over your shoulder. In the event of a frontal impact, a loose lap belt could slide over your hips, leading to abdominal injury. In addition, the safety belt's restraint effectiveness is reduced if the belt is worn loosely. Expectant mothers should always wear their safety belts, taking care to position the lap belt against the lower hips, where it will not exert pressure against the abdominal area. ◀

For care instructions, refer to "Car care" on page 136.

 Vehicles with through-loading system*: Please read and comply with the instructions for the center safety belt on page 99. ◀

 If the safety belt system has been subjected to the stresses involved in an accident or otherwise damaged: Have the entire safety belt mechanism replaced by your BMW center, including the safety belt tensioner. In addition, have your BMW center inspect the safety belt anchors. If a child restraint system was in the vehicle during an accident, consult the manufacturer's instructions regarding replacement. ◀

Child restraint systems*

 Do not install a rear-facing child restraint system in the front passenger seat of your vehicle. If you do so, the child could be injured in an accident when the airbag is triggered. Do not modify the child restraint system in any way. If you do so, it will not provide your child with maximum protection. ◀

54 Airbags

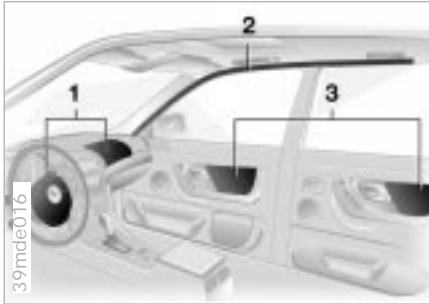

- 1 Front airbag for driver and passenger
- 2 Side impact Head Protection System (front)
- 3 Side airbags (front and rear side*)

Protective effect

The front airbags supplement the three-point safety belts by providing additional protection for the front-seat occupants in the event of a severe frontal collision in which the protection afforded by the belts alone may no longer be sufficient. The head protection and side airbags help provide protection in the event of a collision from the side. Each of the side airbags is designed to help support the upper body.

 The side airbags in the rear passenger area* of your vehicle may already have been deactivated, either at the time of manufacture or by a BMW center. You may have them activated if you desire to do so. Please contact your BMW center for additional information. ◀

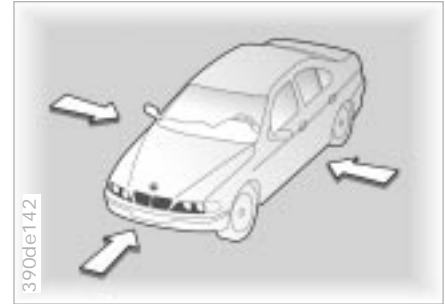

The illustration depicts schematically the primary directions of vehicle impact that initiate an airbag deployment.

Airbags

Indicator lamp



The indicator lamp displays the operational status of the airbag system with the ignition key in position 1 and higher.

System operational:

- ▷ The indicator lamp comes on briefly then goes out.

System malfunction:

- ▷ The indicator lamp fails to come on.
- ▷ The indicator lamp comes on briefly before going out and then lighting up again.

A system malfunction could prevent the system from responding to an impact occurring within its normal response range.

Please have your BMW center inspect and repair the system as soon as possible.

Correct seating posture with airbags



For your own safety, please observe the following precautions concerning airbags. If you do not, their protective function may be impaired and your personal safety in jeopardy. This information applies to all vehicle occupants: The airbags are a supplemental restraint device designed to provide extra protection; they are not a substitute for safety belts. Wear your safety belt at all times. The airbags will not be triggered in the event of a minor accident, a vehicle roll-over, or collisions from the rear. In this case, the safety belt offers the best protection. Airbags are located under cover panels in the steering wheel, dashboard, front and rear* side trim panels, windshield pillars and the sides of the headliner. Select a seat position that is comfortable and allows the greatest possible distance from the airbags in your seating area. To avoid injuries to your hands and arms, always grasp the steering wheel on the rim with your hands at the

9 o'clock and 3 o'clock positions. Do not place your hands on the center pad. Never allow any objects to obstruct the area between the airbag and an occupant.

Do not use the cover panel above the passenger-front airbag as a storage area.

Never tape the airbag cover panels, cover them over or alter them in any other way.

Do not install a rear-facing child restraint system in the front passenger seat of this car. Children under 13 years of age and children less than 5 feet (150 cm) tall should ride only in the rear seat.

If your car is equipped with side airbags in the rear passenger area, be sure that child restraints are mounted correctly and provided with the greatest-possible distance between the airbags in the side trim panels. Do not allow children to lean out of the child seat in the direction of the side trim panels. Otherwise, serious injuries could occur if the airbag is triggered (if activated per customer request). ◀

At all times, occupants should sit upright and be properly restrained (infants and small children in appropriate child restraint systems; larger children and adults using the safety belts). Never let an occupant's head rest near or on a side airbag because the inflating airbag could cause a serious or fatal injury. Please note that the word "Airbag" imprinted on the door trim panel indicates the airbag's location.

Infants or small children should never be held on the lap of a passenger.

Accident research shows that the safest place for children in an automobile is in the rear seat. However, a child sitting in the rear seat and not properly restrained may place his or her head on or near the side airbag, if so equipped. For example, a child – even though belted – may fall asleep with his or her head against the side airbag. It may be difficult for a driver to ensure that children in the rear seat will remain properly positioned at all times and not place their heads on or near the side airbag.

Therefore, we recommend that the rear-seat side airbags, if provided, be deactivated if children will be travelling in the rear seat.

The rear seat side airbags may already have been deactivated, either at the time of manufacture or by a BMW center. Labels in the rear door opening should indicate the status of your rear seat side airbags. If you are uncertain of their status, or wish to have the airbags activated or deactivated, please contact your BMW center.

Even when all these guidelines are observed, there is still a small residual risk of injuries to the face, hands and arms occurring from airbag deployment in isolated instances.

The ignition and inflation noise may provoke a mild temporary hearing loss in extremely sensitive individuals.

Airbag warning information is also provided on the sun visors.

For additional information concerning the airbag system, refer to pages [139](#) and [164](#).



This is the right way for a child to sit in a child restraint when rear side airbags (arrow) are provided.



This is the right way for a larger child to sit wearing the safety belt when rear side airbags (arrow) are provided.

58 Child restraints*

Commercially-available child restraint systems are designed to be secured with a lap belt or with the lap belt portion of a combination lap/shoulder belt. Improperly or inadequately installed restraint systems can increase the risk of injury to children. Always read and follow the instructions that come with the system.

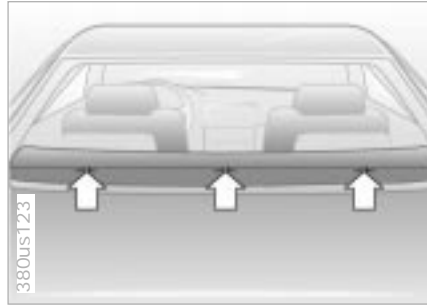

If you use a child restraint system with a tether strap, three additional tether anchor points have been provided (refer to the arrows in the illustration). Depending on the location selected for seating in the rear passenger area, attach the strap hook to the corresponding anchor point to secure the child restraint system.

If the respective seating position is fitted with a headrest lift the headrest and pass the tether strap between the headrest and the seat back.

Adjust the tether strap according to the child restraint manufacturer's instructions.

Child restraints*



Before installing any child restraint device or child seat, please read the following:

Never install a rear-facing child restraint system in the front passenger seat of this car.

Your car is equipped with an airbag supplemental restraint system for the front passenger. Because the backrest on any rear-facing child restraint system (of the kind designed for infants under 1 year and 20 lbs./9 kg) would be within the airbag's deployment range, you should never mount such a device in the front passenger seat, since the impact of the airbag against the child restraint's backrest could lead to serious or fatal injuries.

If it is necessary for a child (not an infant) to ride in the front seat, certain precautions should be taken. First, move the passenger seat as far away from the dashboard as possible. This important precaution is intended to maximize the distance between the airbag and the child. Older children should be tightly secured with a safety belt.

Younger children should be secured in an appropriate forward-facing child restraint system that has first been properly secured with a safety belt. Never install a rear-facing child restraint system in the front passenger seat. We strongly urge you to carefully read and comply with the instructions for installation and use provided by the child restraint's manufacturer whenever you use such a device.

Be sure that all occupants (of all ages) remain properly and securely restrained at all times. ◀

All rear seating positions in your vehicle meet the recommendations of SAE J1819, an industry-recommended practice for securing child restraint systems in motor vehicles.

60 Child seat security



All of the rear belt retractors and the front passenger's safety belt can be locked for mounting and securing child restraint systems.

Information regarding this is located near the buckle latch of each safety belt.

To lock the belt

Pull the entire length of the belt from the belt retractor. Allow the reel to retract the belt somewhat and engage the buckle, then tighten the belt against the child restraint system. The retraction mechanism is now locked.

To release the belt

Release the buckle, remove the child-restraint device and allow the inertia reel to retract the belt completely.

Child-safety locks



Insert the key into a rear door lock and turn it outward:

The door can now be opened from the outside only.

Steering/Ignition lock

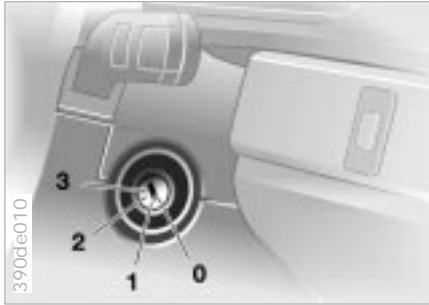

0 Steering lock engaged

The key can be inserted and removed in this position only.

An acoustic warning is sounded when you fail to remove the ignition key after opening the driver's door.

After removing the key, turn the steering wheel slightly to the left or right until you hear the lock engage.

1 Steering lock disengaged

Turning the steering wheel slightly to the right or left often makes it easier to turn the key from 0 to 1.

Individual electrical accessories are ready for operation.

2 Ignition on

All electrical equipment and accessories are available for use.

3 Starting the engine

62 Starting the engine

Before starting

- ▷ Engage the parking brake.
- ▷ Move the shift lever to the neutral position.
- ▷ Depress the clutch pedal.

 Do not allow the engine to run in enclosed spaces. The exhaust gases contain carbon monoxide, an odorless and colorless, but highly toxic gas. Breathing the exhaust gases poses an extreme health risk, and can lead to unconsciousness and death. Never leave the car unattended with the engine running. An unattended vehicle with a running engine represents a potential safety hazard. ◀

Starting the engine

- ▷ Start the engine. Do not press the accelerator pedal.

 Do not actuate the starter for too short a time. Do not turn it for more than approx. 20 seconds. Release the ignition key immediately as soon as the engine starts.

Do not allow the engine to warm up by leaving it running while the vehicle remains stationary. Instead, begin driving immediately at a moderate engine speed. ◀

If the engine does not start on the first attempt (the engine is very hot or cold, for instance):

- ▷ Press the accelerator pedal halfway down while engaging the starter.

Cold starts at very low temperatures, from approx. +5 °F (-15 °C) and at altitudes above 3,300 feet (1,000 m):

- ▷ On the first start attempt, engage the starter for a longer period (approx. 10 seconds).
- ▷ Press the accelerator pedal halfway down while engaging the starter.

Engine idle speed is controlled by the engine computer system. Increased speeds at startup are normal and should decrease as the engine warms up. If engine speed does not decrease, service is required.

To prevent the battery from discharging, always switch off any electrical devices not in use, as well as the ignition when the vehicle is not being driven.

Switching off the engine

Turn the ignition key to position 1 or 0.

 Do not remove the ignition key while the vehicle is still moving. If you do so, the steering will lock, making it impossible to steer the vehicle. When you leave the vehicle, always remove the ignition key and engage the steering lock.

Always engage the parking brake when parking on slopes and inclined surfaces. Placing the lever in 1st gear or reverse may not provide adequate resistance to rolling. ◀

Parking brake



To engage

The lock engages automatically when you lift the lever, and the "PARK BRAKE" (in Canada "P") indicator lamp comes on in the instrument cluster in ignition key position 2. Refer to page 21.

To release

Pull up slightly on the lever, press the button and lower the lever.

The parking brake is primarily designed to prevent the vehicle from rolling while parked. It operates against the rear wheels.



If, in exceptional circumstances, it should be necessary to engage the parking brake while the vehicle is in motion, do not pull it with excessive pressure. Keep your thumb pressed against the release button while carefully pulling up the lever to apply moderate pressure.

Excessive pressure can lead to over-braking and loss of traction (fishtailing) at the rear axle.

The brake lamps do not come on when the parking brake is engaged.

Always engage the parking brake when parking on slopes and inclined surfaces since placing the lever in 1st gear or reverse may not provide adequate resistance to rolling. ◀

To avoid corrosion, apply the parking brake lightly from time to time when coasting to a standstill (at a traffic signal, for instance), provided that it is safe to do so.



The shift lever's neutral gate is located between 3rd and 4th gears.

When shifting from each gear into "Neutral," the shift lever returns automatically to this neutral position because of its spring loading.

When the vehicle lighting is switched on, the shift pattern is illuminated on the shift lever.

 When shifting gears in the 5th/6th-gear plane, be sure to press the shift lever to the right in order to prevent inadvertent selection of a gear in the 3rd/4th-gear plane. ◀

Reverse

Select "Reverse" only when the vehicle is stationary. Press the shift lever to the left to overcome a slight resistance.

As you do this, the backup lamps will turn on automatically when the ignition key is in position 2.

 Do not hold the vehicle in place on slopes by slipping or "riding" the clutch. Use the parking brake instead. A slipping clutch increases clutch wear. ◀

Turn signal/Headlamp flasher

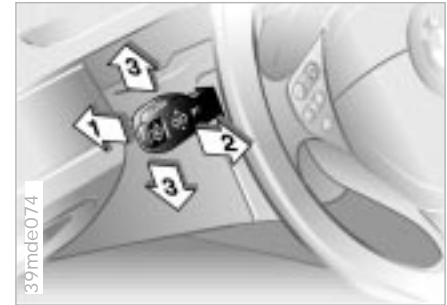

- 1 High beam (blue indicator)
- 2 Headlamp flasher (blue indicator)
- 3 Turn signal indicator (green indicator accompanied by periodic clicking sound from the relay).

If the indicator lamp and the "ticking" from the relay are both faster than normal, one of the turn indicators has failed.

To signal briefly

Press the lever up to but not beyond the detent. It then returns to the center position when released.



- 0 Wipers retracted
- 1 Intermittent wipe or rain sensor*
- 2 Normal wipe
- 3 Fast wipe
- 4 Brief wipe
- 5 Automatic windshield washer
- 6 Automatic intensive-action washer*
- 7 Rotary dial for control of the wipe interval or the sensitivity of the rain sensor

1 Intermittent wipe or rain sensor*

Intermittent wipe:

You can set the wipe interval to four stages with rotary dial 7. In addition, the wipe interval automatically adapts to variations in road speed.

Rain sensor:

When the rain sensor is activated, the windshield wiper is controlled automatically, depending on the degree of wetness of the windshield (in both snow and rain). You do not have to be concerned with switching the windshield wiper on or off or adjusting the wipe interval between intermittent and full wipe. Instead, you can concentrate fully on the traffic conditions. This is especially important under adverse weather conditions.

The rain sensor is positioned on the windshield, directly ahead of the interior rearview mirror.

To activate the rain sensor:

Move the lever to position 1 with the ignition key in position 1 or higher. The wipers travel once across the windshield, regardless of the weather conditions.

You can also leave the lever permanently in position 1. It is then only necessary to activate the rain sensor from ignition key position 1 and higher. To do this,

- ▷ turn rotary dial 7 briefly or
- ▷ use either the automatic windshield washer 5 or the automatic intensive-action washer 6.

To modify the sensitivity of the rain sensor:

Turn rotary dial 7.

 Turn the rain sensor off in automatic car washes. If you do not, damage may occur if the wipers switch on unintentionally. ◀



2 Normal wiper speed

When the vehicle is stationary, the wipers switch automatically to intermittent wipe (not on vehicles with rain sensor).

3 Fast wiper speed

When the vehicle is stationary, the wipers operate at normal speed (not on vehicles with rain sensor).

5 Automatic windshield washer

The system sprays washer fluid against the windshield and activates the wipers for a brief period.

If you pull the lever only briefly, the system sprays washer fluid onto the windshield without activating the wipers.

6 Automatic intensive-action washer*

As at 5. In addition, an intensive-action washer fluid is first sprayed on the windshield.

For changing the wiper blades, refer to page 144.

Headlamp washers*

If the headlamps are on, they will also be cleaned every fifth time you activate the automatic windshield washer (intensive-action or standard wash/wipe).



Do not use the washers if there is any danger that the fluid will freeze on the windshield. If you do so, your vision could be obscured. For this reason, use an antifreeze agent. Refer to page 126. Do not press the washer lever if the supply tank is empty. If you do so, the washer pump will be damaged. ◀

Windshield washer jets

The windshield washer jets are warmed automatically when the ignition key is in position 2.

Rear window defroster

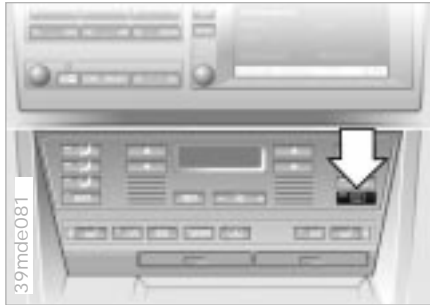

To activate

Press the button: as long as the indicator lamp remains on, the rear window defroster continues at high-output (rapid thaw).

After the indicator lamp goes out, the defroster continues operating at reduced power for a limited period before deactivating automatically.

To deactivate

If the indicator lamp is still on, press the button.

Cruise control



You can store and automatically maintain any desired vehicle speed above approx. 20 mph (30 km/h).

To activate the system

From ignition key position 2: Press button 1. The indicator lamp in the instrument cluster comes on. You can now use the cruise control.

To store and maintain speed or to accelerate

Press button 2 briefly: The system registers and maintains the current vehicle speed. Every time you briefly touch the button, the speed increases by approx. 0.6 mph (1 km/h).

Press and hold button 2:

The vehicle accelerates without pressure on the accelerator pedal. When you release the button, the system registers and maintains the current speed.

 If, on a downhill gradient, the engine braking effect is not sufficient, the controlled speed can be exceeded. Speed can drop on uphill grades if the engine output is insufficient. ◀

To decelerate

Press button 3 briefly:

When cruise control is active, every brief touch of the button reduces the speed by approx. 0.6 mph (1 km/h).

Press and hold button 3:

With the cruise control active, the system automatically reduces the throttle opening to slow the vehicle. When you release the button, the system registers and maintains the current speed.

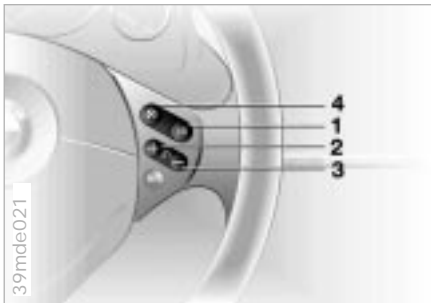

To cancel the cruise control

When the system is activated, press button 1. The indicator lamp stays on. You can use the cruise control again as required.

In addition, cruise control is canceled automatically

- ▷ if the brakes are applied,
- ▷ when you depress the clutch pedal,
- ▷ or if the cruise speed is either exceeded or not met for an extended length of time (if you depress the accelerator pedal and exceed the set speed, for example).

To resume the stored setting

Press button 4:

The vehicle accelerates to and maintains the last speed stored. When you turn the ignition key to position 0, the stored speed is deleted from the system's memory and the system is deactivated.

To deactivate the system

When the cruise control has been canceled, press button 1 again. The indicator lamp goes out and the stored speed is deleted.



Do not use cruise control on twisting roads, when high traffic density prevents driving at a constant speed, when the road surface is slick (snow, rain, ice), or when the road surface is loose (rocks or gravel, sand). ◀



Odometer

You can activate the displays shown in the illustration with the ignition key in position 0 by pressing the button in the instrument cluster (arrow).

The range of available displays varies according to your individual car's equipment.

Trip odometer

To reset the trip odometer to zero, press the button (arrow) with the ignition key in position 1 or higher.

Outside temperature display

The outside temperature appears in the display panel from ignition key position 1 and higher.

You can change the units of measurement (°C/°F) by

- 1 pressing and holding the button (arrow) with the ignition key in position 1
- 2 and then turning the ignition key to 0.

Ice warning

If the outside temperature drops to approx. +37.5 °F (+3 °C), a signal is sounded as a warning and the display flashes for a brief period. The warning is repeated whenever the temperature climbs to at least +43 °F (+6 °C) following the last warning and then drops back to +37.5 °F (+3 °C).



The ice warning does not alter the fact that surface ice can form at temperatures above +37.5 °F (+3 °C), on bridges or shaded road surfaces, for instance. ◀

70 Tachometer



The orange early warning zone appears depending upon the engine temperature. As the engine temperature increases, more and more sectors of this early warning zone disappear.

Avoid engine speeds in the early warning zone if possible.

Do not operate the engine with the needle in the red overspeed zone of the gauge.

To protect the engine, the engine-management system automatically interrupts the fuel supply in this range; the resulting effect resembles that associated with a sudden loss of power.

Engine oil temperature



The normal operating temperature is in a range between +176 °F (+80 °C) and +248 °F (+120 °C). Do not exceed the maximum temperature of +302 °F (+150 °C).

Fuel gauge



When you switch on the ignition, the indicator lamp comes on briefly to confirm that the system is operational.

If the indicator lamp comes on and stays on, there are approx. 2.6 gal (10 liters) of fuel still in the tank.

For fuel tank capacity, refer to page [175](#).

If the tilt of the vehicle varies (when you are driving in mountainous areas, for example), the needle may fluctuate slightly.



Please refuel early, as driving to the last drop of fuel can result in damage to the engine and/or catalytic converter. ◀

Coolant temperature gauge



Between the blue and red zones

Normal operating range. It is not unusual for the needle to rise as far as the edge of the red zone in response to high outside temperatures or severe operating conditions.

Checking coolant level: page [129](#).

Blue

The engine is still cold. Drive at moderate engine and vehicle speeds.

Red

If the warning lamp comes on or the message "COOLANT TEMPERATURE" is displayed in the Check Control: The engine is overheated. Shut off the engine immediately and allow it to cool down.

Service Interval Display 71



Green lamps

The number of illuminated lamps decreases as the time for your next maintenance visit approaches.

Yellow lamp

This field appears together with OILSERVICE or INSPECTION. Maintenance is due. Please contact your BMW center for an appointment.

Red lamp

The maintenance deadline has been passed.



Text messages are used to alert the driver to system malfunctions with the ignition key in position 2 and higher. The alert is accompanied by a gong.

- 1 Status symbol for messages
- 2 Display
- 3 CHECK button.

Messages concerning system faults are differentiated based on two priorities:

Priority 1

These defects are immediately indicated by a gong and a flashing warning symbol (1). Simultaneous defects will be displayed consecutively. These status messages remain in the display until the defects are corrected. They cannot be deleted by pressing the CHECK button (3):

- ▷ "RELEASE PARKINGBRAKE"
- ▷ "COOLANT TEMPERATURE"
The coolant is overheated. Stop the vehicle and switch off the engine immediately. Refer to page [129](#).
- ▷ "STOP! ENGINE OILPRESS"
The oil pressure is too low. Stop the vehicle and switch off the engine immediately. Refer to page [127](#).

▷ "CHECK BRAKE FLUID"

The level has dropped nearly to the minimum. Top up the brake fluid at the next opportunity. Refer to page [130](#). Have the source of the brake fluid loss diagnosed and corrected by your BMW center.

▷ "FLAT TIRE"

Reduce vehicle speed immediately and stop the vehicle. Avoid hard brake applications. Do not oversteer. Refer to page [78](#).

▷ "LIMIT"*

This is displayed if the programmed speed limit has been exceeded.

Check Control

Priority 2

These displays appear for 20 seconds with the ignition key in position 2 and higher. The warning symbols remain after the message disappears. You can display the messages again by pressing the CHECK button 3.

▷ "TRUNK LID OPEN"

This message appears only when you initially begin a trip.

▷ "DOOR OPEN"

This message appears after a minimal defined road speed has been exceeded.

▷ "FASTEN SEAT BELTS"*

In addition to this message, an indicator lamp with the safety belt icon appears and an acoustical signal is sounded.

▷ "WASHER FLUID LOW"

Too low; top up fluid at the next opportunity. Refer to page 126.

▷ "CHECK ENGINE OIL LEV"

Add engine oil as soon as possible. Refer to page 127.

▷ "TIRE PRESSURE SET"

The RDW has transferred the current inflation pressure in the tires as the target values that the system will monitor. Refer to page 77.

▷ "CHECK TIRE PRESSURE"

Check the tire inflation pressure and adjust it to the correct specifications at the earliest opportunity (next stop for fuel). Refer to page 78.

▷ "TIRE CHECK INACTIVE"

This indicates a temporary interference in the RDW or a system fault. Refer to page 78.

▷ "CHECK BRAKE LAMPS"

A lamp has failed or the electrical circuit has a fault. Refer to page 147 and 156 or consult an authorized BMW center.

▷ "CHECK LOWBEAM LAMPS"

"CHECK SIDE LAMPS"

"CHECK REAR LAMPS"

"CHECK FRONT FOGLAMPS"*

"CHECK LICPLATE LAMP"

"CHECK HIGHBEAM LAMP"

"CHECK BACK UP LAMPS"

Defective bulb or circuit. Refer to page 145 ff. and 156 or consult an authorized BMW center.

▷ "CHECK BRAKE LININGS"

Have the brake linings checked by your authorized BMW center. Refer to page 112.

▷ "CHECK COOLANT LEVEL"

The coolant level is too low; top up at the next opportunity. Refer to page 129.

▷ "CHECK FUEL TANK LID"

Check the fuel tank door at the next opportunity to be sure it is closed.

▷ "ENGINE FAILSAFE PROG"

Fault in the Electronic Engine Power Control EML. Higher brake application pressure may be necessary when braking. Have the system inspected by your authorized BMW center.

The following message cannot be called up for display again:

▷ "OUTSIDE TEMP 24 °F (-5.0 °C)"

This temperature display is only an example. The current temperature is displayed at outside temperatures of 37.5 °F (+3 °C) and below. Refer also to page 69.

Displays after completion of a trip

All of the malfunctions registered during the trip appear consecutively when the key is turned to position 0.

The following displays will appear when appropriate:

▷ "LIGHTS ON"

This display appears when you open the driver's door after parking the vehicle.

▷ "KEY IN IGNITION LOCK"

▷ "CHECK ENGINE OIL LEV"

Check the engine oil at the earliest opportunity (next stop for fuel). Refer to page [127](#).

Status messages remain available for a period of approx. three minutes after the display goes out and the key is removed from the ignition. Press the CHECK button (3) to display these messages. If there were multiple messages, press the CHECK button repeatedly to view them all in sequence.

To check the Check Control

Press the CHECK button (3) with the ignition key in position 2: CHECK CONTROL OK appears in the display.

There are no faults in the monitored systems.

Onboard computer

You will find a description of the onboard computer in the "Onboard computer" Owner's Manual.



You can have the Check Control and onboard computer messages displayed in a different language. ◀

**Mode selection**

With the ignition key in position 1 and higher, you can use the button in the turn signal lever to retrieve information from the onboard computer for display in the instrument cluster. By pressing the button briefly in the direction of the steering column, you can call up a new function for display.

The PDC assists you when you back into a parking space. A signal warns you of the distance to an obstacle. To do this, four ultrasonic sensors in the rear bumper measure the distance to the nearest object. The monitoring range for the two corner sensors ends approx. 2 feet (60 cm) beyond the bumper. The range of the two middle sensors is slightly less than 5 feet (1.50 meters) outward.

The system is activated automatically about one second after you engage reverse with the ignition key in position 2. PDC is deactivated when you shift back out of reverse.

Acoustical signals

The distance to the nearest object is indicated by a tone sounding at various intervals. As the distance between vehicle and object decreases, the intervals between the tones become shorter. A continuous tone indicates the presence of an object less than 1 ft. (30 cm) away.

The warning signal is canceled after approx. three seconds if the distance to the obstacle remains constant during this time (if you are moving parallel to a wall, for instance).

System malfunctions will be indicated by a continuous high-pitched tone when the system is activated the first time. Please have your BMW center resolve the problem.



The PDC does not remove the driver's personal responsibility for evaluating the distance between the vehicle and any obstacles. Even when sensors are involved, there is a blind spot in which objects cannot be detected. This applies especially in those cases where the system approaches the physical limits of ultrasonic measurement, as occurs with tow bars and trailer couplings, and in the vicinity of thin and painted objects. Certain sources of sound, such as a loud radio, could drown the PDC signal tone. ◀



Keep the sensors clean and free of ice or snow in order to ensure that they will continue to operate effectively. Do not apply high-pressure spray to the sensors for a prolonged period of time. Maintain an adequate distance of more than 4 inches (10 cm). ◀

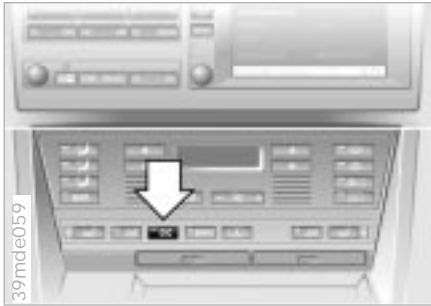

This system ensures enhanced vehicle stability, particularly when accelerating and cornering.

In addition to optimized traction and vehicle stability when starting from a standstill or accelerating, there is the further benefit of enhanced stability in cornering. Of course, these benefits are only possible within the limits imposed by the laws of physics.

The system activates automatically each time you start the engine.

Indicator lamp



The indicator lamp in the instrument cluster goes out shortly after you switch on the ignition.

Refer to page [21](#).

Indicator lamp flashes:

The system is actively regulating drive torque in response to monitored vehicle operating conditions.

If the indicator lamp fails to go out after the engine is started, or comes on during the course of normal vehicle operation:

There is a system fault. You can still drive the vehicle normally, but the DSC function is not available. Consult your BMW center for repair.

To deactivate the system

Press the button. The indicator lamp will come on.

When DSC is deactivated, you are driving with conventional power transfer.

We recommend that you deactivate the system for increased traction:

- ▷ when rocking the vehicle or starting off in deep snow or on loose surfaces
- ▷ or when driving with snow chains.

Refer also to page [110](#).

To reactivate the system

Press the button again; the indicator lamp goes out.



The laws of physics cannot be repealed, even with DSC. Any consequences arising from traction loss due to excessive vehicle speed remain the responsibility of the driver. We therefore urge you to avoid using the additional safety margin of the system as an excuse for taking risks. ◀

For additional details concerning DSC, please refer to the chapter describing "Advanced technology" on page [161](#).



Whenever it is required, this system changes the settings of the Servotronic power steering, and the accelerator pedal response from a performance-comfort mode to a pure performance mode. That is, steering response becomes more performance-oriented and the response of the accelerator pedal is much more spontaneous (Performance Recognition).

Performance Recognition

With the ignition key in position 2, press the key (arrow). The indicator lamp illuminates.

Deactivating Performance Recognition: Press the button again; the indicator lamp goes out.

The coordinated performance-comfort mode is activated automatically each time you start the engine.

The concept

RDW monitors the tire pressure at all four wheels – even while you are driving. The system provides an alert whenever the inflation pressure drops significantly below the specified pressure in one or more tires.

In order for the system to "learn" the correct tire inflation pressure, check the inflation pressure in all tires according to the inflation pressure table beginning on page 26 and make corrections as necessary. Then activate the system.

The Check Control (refer to page 73) will inform you if the tire pressure is not correct.



Activate the system

- 1 Turn the ignition key to position 2 (do not start the engine).
- 2 Press and hold the button (arrow) until the message "SET TIRE PRESSURE" is displayed for a few seconds in the Check Control.
- 3 After you have driven a few minutes, RDW transfers the current tire inflation pressures as the nominal values to be monitored.

You will only have to repeat this procedure following a correction of the tire inflation pressure. Otherwise, the system is automatically activated in ignition key position 2 and therefore whenever the vehicle is driven.

78 Tire Pressure Warning (RDW)

Loss in tire pressure

If, after a certain period of time, the air pressure has gone down (which is normal for any tire), the message "CHECK TIRE PRESSURE" appears in the Check Control

This alerts you to have the tires inflated to the specified pressures as soon as possible.



If you are prompted to check the tire pressure shortly after a correction has been made, this indicates that the corrected values were not accurate. Please check the inflation pressure again and make corrections according to the inflation pressure table. Then activate the system once again. ◀

Flat tire

If there is a tire failure with a loss of air pressure, the message "TIRE DEFECT" appears in the Check Control. In addition, a gong is sounded.

If this occurs, reduce vehicle speed immediately and stop the vehicle in a safe location. Avoid hard brake applications. Do not oversteer. Correct the tire failure using the M Mobility system (refer to page 150).



RDW cannot inform you of sudden and severe tire damage caused by external influences. ◀



Have the tires changed by your BMW center.
Your BMW center has the information needed for working with RDW and is equipped with the necessary special tools. ◀

System interference

The message "TIRECONTROL INACTIVE" appears in the Check Control for the duration of the system interference.

The same display will appear if there is a system fault.

Please contact your BMW center for additional information.



Side lamps (side marker lamps)



With the switch in this position, the front, rear and side vehicle lighting is switched on. For lighting on one side for parking, see page 80.

Low beam headlamps



When you switch off the ignition and the low beams are still on, only the position lamps (side marker lamps) remain on.



"Follow-me-home lighting:"
If you actuate the headlamp flasher after you have parked the vehicle and shut off the engine, the low beams will remain on for a brief period. You may also have this function deactivated if you wish. ◀

LIGHTS ON warning

With the ignition key in position 0, this message is displayed in the Check Control after the driver's door is opened if the headlamps have not been switched off.

Daytime running lamps*

The headlamps are automatically switched on for daylight driving at ignition key position 2.



Turn the rotary dial to adjust the lighting intensity.

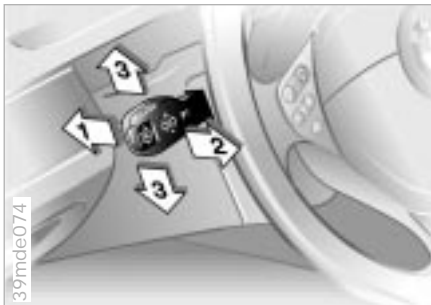

- 1 High beam (blue indicator lamp)
- 2 Headlamp flasher (blue indicator lamp)
- 3 Parking lamp

Parking lamp, left or right

With the ignition key in position 0, press the turn signal lever from the center position in the desired direction. The lever engages in the turn signal position.



Fog lamps



A green indicator lamp appears in the instrument cluster to indicate that the front fog lamps are on.

If the high beam is switched on, the fog lamps go out.



Comply with the legal regulations concerning the use of fog lamps. ◀

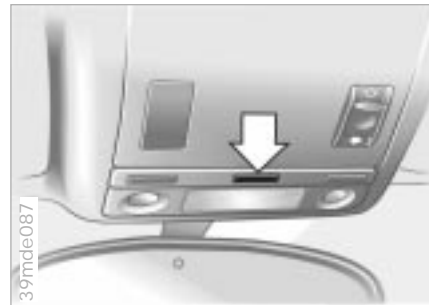

The interior lamps operate automatically.

Switching the interior lamps on and off

Press the button (arrow).

If you wish the interior lamps to remain off at all times, press and hold the button for approximately 3 seconds.

Press the button briefly to revert to normal operation.

Footwell lamps

The footwell lamps operate in the same way as the interior lamp.

Reading lamps

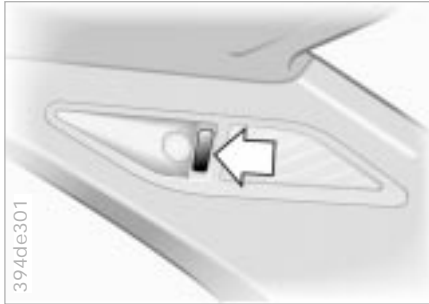

The reading lamps are located in the front near the interior lamp. There are also reading lamps in the rear. They can be switched on and off with the switch (arrow) next to each lamp.

 In order to prevent battery discharge, all of the lamps in the vehicle are switched off automatically approx. 15 minutes after the ignition key is turned to position 0. ◀

82 Automatic climate control

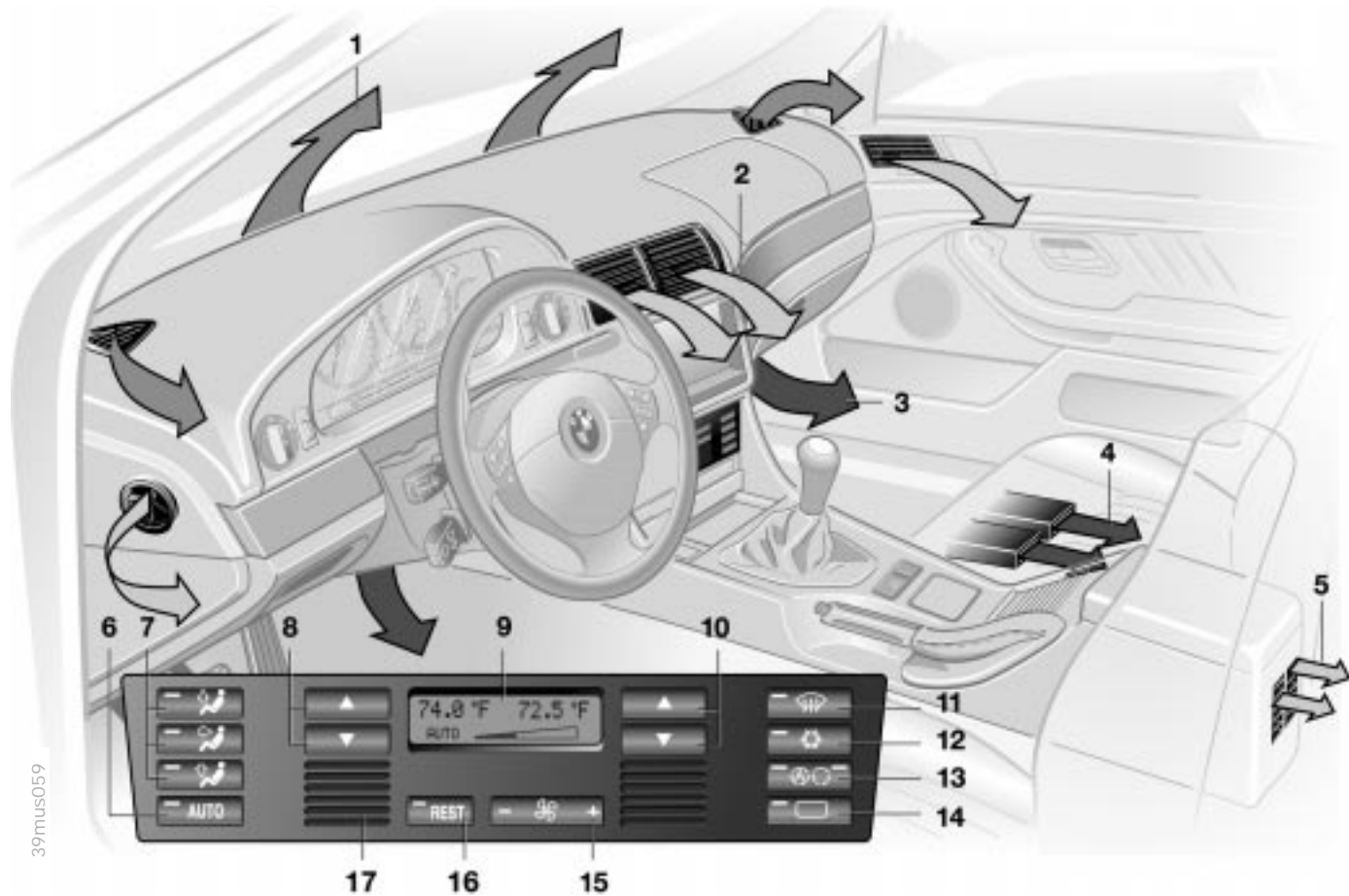

Automatic climate control

- 1 Air flow directed toward the windshield and side windows
- 2 Air flow for the upper body
The side rotary dials allow you to open and close the air supply through an infinitely-variable range, while the levers change the airflow direction. The center rotary dial controls the temperature of the air as it flows out, see page [86](#)
- 3 Front footwell ventilation
- 4 Rear footwell ventilation
- 5 Air flow for the upper body in the rear seat [87](#)
- 6 Automatic air distribution [84](#)
- 7 Individual air distribution [84](#)
- 8 Temperature control – left-hand side [84](#)
- 9 Display for temperature and air supply [84](#)
- 10 Temperature control – right-hand side [84](#)
- 11 To defrost windows and remove condensation [85](#)
- 12 Air conditioner [85](#)
- 13 Automatic recirculated air control (AUC) [85](#)
- 14 Rear window defroster [67](#), [86](#)
- 15 Air supply [85](#)
- 16 Residual heat mode [86](#)
- 17 Air grill for interior temperature sensor – please keep clear and unobstructed

Tips for pleasant driving

Use the automatic system (AUTO button 6). Select an interior temperature that is comfortable for you – we recommend 72 °F (22 °C). When the outside temperature is above 41 °F (5 °C), you can also use the air conditioner 12.

This will dry the air as well as preventing condensation on the window surfaces – if there are passengers with damp clothing, for example. Set the air outlets 2 so that the air flows past you and is not directed straight at you. Set the rotary dial between the air outlets 2 for the upper body to a medium position, since air that is somewhat cooler promotes driving without fatigue.

The following description will lead you through additional individual adjustments.





Your BMW center can program the settings of your vehicle in such a manner that, when you unlock the car with your individualized remote control, your own personalized setting for the automatic climate control is initiated. ◀

Automatic air distribution

The AUTO program assumes the adjustment of the air distribution and the air supply for you and – in addition to that – adapts the temperature to external influences (summer, winter) to meet preferences you can specify. This program maintains a comfortable in-car climate regardless of the season. Select an interior temperature that is comfortable for you – we recommend 72 °F (22 °C). The selected temperature and AUTO for the air supply appear in the display 9. Refer to the overview on page 82. Open the air outlets for the upper body. Switch on the air conditioner in warm weather. The maximum cooling capacity is achieved when you set rotary dial 3 (refer to page 86) to cold.

Individual air distribution

You can cancel the AUTO program by selecting specific distribution patterns to suit your own individual requirements. You can direct air to flow onto the windows , toward the upper body , and into the footwell .

Temperature

You can make individual temperature adjustments on the driver's side or the front passenger side. The figures in the display provide a general indication of interior temperature. We recommend 72 °F (22 °C) as a comfortable setting, whether the air conditioner is operating or not. When you start the vehicle, this system ensures that the selected temperature is achieved as quickly as possible. It then maintains this temperature, regardless of the season.

Set the rotary dial 3 (refer to "Draft-free ventilation" on page 86) to a medium setting, since air that is somewhat cooler promotes driving without fatigue. Utilize this method of mixing air especially for making minor adjustments for personal comfort.



You can set uncontrolled heater output up to 90 °F (32 °C). Full cooling output is available from the air conditioner down to 60 °F (16 °C). ◀

Automatic climate control

Air supply

 In the "AUTO" program, the air supply is controlled automatically. AUTO will appear in the display 9. Refer to the overview on page 82. Use "+" and "-" to vary the air supply. Your setting is displayed with bars and the automatic air supply is switched off. The automatic air distribution setting is maintained. You can reactivate the automatic air supply by pressing the "AUTO" button.

When you press "-" during operation at the lowest blower speed, all displays are canceled: The fan, heating and air conditioner are switched off. The outside air supply is closed. You can switch the system back on by pressing any button of the automatic climate control (except the REST button 16).

To defrost the windshield and side windows

 This program quickly removes ice and condensation from the windshield and the side windows.

Air conditioner

 The air is cooled and dehumidified and – depending on the temperature setting – warmed again when the air conditioner system is switched on. Depending on the weather, the windshield may fog over briefly when the engine is started.

Switch off the air conditioner at outside temperatures below approx. 41 °F (5 °C). This will help to prevent the windows from fogging up. If the windows fog over after switching the air conditioner off, switch it back on.

 Condensation forms in the air conditioner system during operation, which then exits under the vehicle. Traces of condensed water of this kind are thus normal. ◀

Automatic recirculated air control (AUC)

 You can respond to unpleasant external odors by temporarily excluding the flow of outside air. The system then recirculates the air currently within the vehicle. By repeated actuations of the button, you can select one of three different operation modes.

- ▷ Indicator lamps off: Outside air flow operational.
- ▷ Left-hand indicator lamp on – AUC mode: The system recognizes pollutants in the outside air and blocks the flow of air when necessary. The system then recirculates the air currently within the vehicle. Depending on the air quality, the automatic system then switches back and forth between outside air supply and recirculation of the air within the vehicle.
- ▷ Right indicator lamp on – recirculated air mode: The flow of external air into the vehicle is completely blocked. The system then recirculates the air currently within the vehicle.

 If the windows fog over in the recirculated air mode, switch the recirculated air off and increase the air supply as required. ◀

Rear window defroster

 When the rear window defroster is activated, the indicator lamp comes on. The rear window defroster switches off automatically.

Residual heat mode

 The heat which is stored in the engine is utilized for heating the interior when the engine has been switched off (while waiting at a railroad crossing, for instance). In ignition key position 1, you can alter the settings of the automatic climate control. With the ignition key in position 0, the system automatically directs heated air to the windshield, side windows and footwells.

 This function may be activated when the outside temperature is below approx. 59 °F (15 °C), the engine is at operating temperature, and the battery is adequately charged. ◀

Latent heat storage system*

This system is activated automatically in the residual heat mode with the ignition key in position 1.

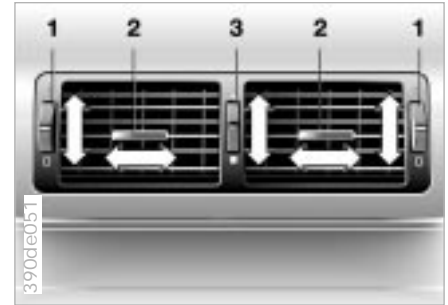
**Draft-free ventilation**

For your optimal personal comfort, you can adjust airflow onto the upper body area from the air outlets:

Use rotary dial 1 to open and close the air outlets through an infinitely-variable range. You can use the levers 2 to adjust the direction of the airflow.

Set the air outlets so that the air flows past you and is not directed straight at you.

Rotary dial 3 allows you to control the temperature of the air flow from these air outlets as desired:

- ▷ Turn toward blue – colder
- ▷ Turn toward red – warmer

Automatic climate control

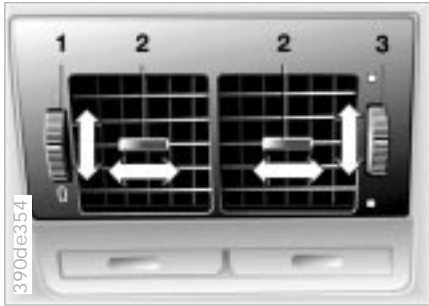

Rear passenger area ventilation

Rotary dial 1 opens the air outlets in an infinitely-variable range. You can vary the temperature of the air as it flows out using rotary dial 3 in the same manner as for the front rotary dial.

You can change the direction of the air flow with levers 2.

Microfilter, activated-charcoal filter

The microfilter removes dust and pollen from the incoming air. The activated-charcoal filter provides additional protection by filtering gaseous pollutants from the outside air. Your BMW center replaces this combined filter as a standard part of your scheduled maintenance. A substantial reduction in air supply indicates that the filter must be replaced before normal maintenance.

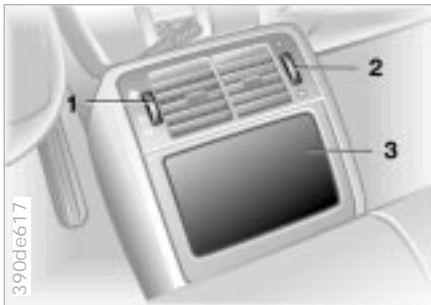

Climate control

- 1 Air supply
- 2 Temperature
- 3 Storage compartment with ventilation

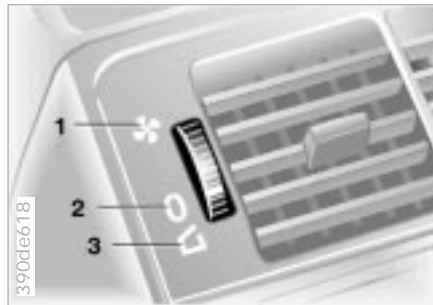

Air supply

- 1 Maximum blower speed
- 2 Blower off
- 3 Storage compartment

You can adjust the air supply for the air outlets and the storage compartment through an infinitely-variable range between the "0" and "Maximum" settings.

When set to "0" and "Storage compartment," the fan is switched off and the air supply through the air outlets is blocked. The storage compartment is ventilated in both settings as follows:

- ▷ "0" setting – warm air
- ▷ "Storage compartment" setting – cold air

Individual adjustments on the front-seat control elements influence the air supply of the rear passenger area climate control.



Temperature

Passengers in the rear seating area can adjust their own temperature for the adjacent air outlets:

- ▷ Turn toward blue – colder
- ▷ Turn toward red – warmer

When you start the vehicle, the system ensures that the selected temperature is achieved as quickly as possible. It then maintains this temperature, regardless of the season.

 A temperature adjustment is only possible when the blower is switched on – it is not possible when set to "0" and "Storage compartment." ◀



Storage compartment with ventilation

Press the cover back gently to open it.

- 1 Slide regulator for opening and closing the air supply:
 - ▷ Regulator to the left – air supply opened
 - ▷ Regulator to the right – air supply closed.
- 2 Beverage holder insert – may also be removed.

90 Seat heating*



The seat cushion and backrest can be heated when the ignition key is in position 2. You can call up different heating modes by repeatedly pressing the keys.

When the three indicator lamps are illuminated, the highest heating mode is activated. One lamp indicates the lowest heating mode. The temperature is regulated with a thermostat in each mode.

You can also switch the higher heating modes off directly: Press the key and hold it slightly longer.

Roller sun blind*

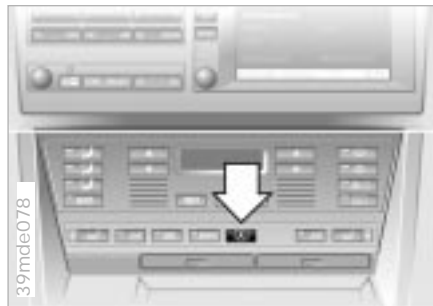

To actuate, press the button briefly with ignition key in position 1.

Roller sun blinds for rear side windows*

Use the strap to pull out the blinds, then hook them in the provided attachment.

Independent ventilation system

This system ventilates the interior and lowers its temperature by using the blower of the automatic climate control, when the vehicle is unattended.

The independent ventilation system is operated via the onboard computer. Refer to the separate Owner's Manual.

You may preselect two different activation times. The ventilation will remain activated for 30 minutes. You can also turn it on and off directly. Because of its high current consumption, you should not activate the system twice in succession without allowing the battery to be recharged while you are driving.

When a preselected activation time is set, the independent ventilation system is operational at outside temperatures above 60 °F (16 °C), or by direct switch activation. It cannot be switched on when the vehicle is moving.

The air emerges via the air outlets for the upper body. Therefore, the air outlets must be open for the system to operate.

You can adjust the airflow volume and the air distribution when the ignition key is in position 1.

The concept

The BMW Universal Transmitter replaces up to three hand-held transmitters that control different devices such as a garage door opener, alarm systems or a door locking system. The BMW Universal Transmitter recognizes and "learns" the transmitted signal from each of the original hand-held transmitters.

The signal of an original hand-held transmitter can be programmed to one of three channel keys. Following that, each of the devices can be operated with the channel key that you have programmed for it. A transmission of the signal is indicated by the indicator lamp. Before you sell your vehicle, the programmed channel keys should be deleted. Refer to page 93 for the description of this process.

 To prevent potential injuries or damage: during the programming operation and before every remote triggering of a programmed device using the BMW Universal Transmitter, be sure that there are no persons, animals or objects within the range of movement of the respective device. Read and comply with the safety instructions for the original hand-held transmitter also. ◀



To Canadian residents
During programming, your hand-held transmitter may automatically stop transmitting after two seconds. This may not be long enough to program the BMW Universal Transmitter. If you are programming from one of these hand-held transmitters, the Universal Transmitter's lamp may begin to flash in a series of double-blinks. If this occurs, continue to hold the button on the Universal Transmitter while you reactivate your hand-held transmitter. You may have to repeat this function several times while programming. ◀



Before programming, read the "User's information" section on page 93. ◀

The original hand-held transmitter



If this symbol is depicted on the packaging or in the user's instructions for the original hand-held transmitter, it may be assumed that this original hand-held transmitter is compatible with the BMW Universal Transmitter.

Checking for the change code

In order to determine whether the original hand-held transmitter is equipped with a change code system, you may either refer to the instructions for the original hand-held transmitter or program a channel key as described in the left column on page 92 under "Programming."

Following that, press and hold the programmed channel key of the BMW Universal Transmitter. If the indicator lamp of the BMW Universal Transmitter flashes rapidly for two seconds and then stays on continuously, the original hand-held transmitter is equipped with a change code system. If the change code system is available, program the channel keys as described in the right-hand column on page 92 under "Programming a hand-held transmitter with change code."



If you have additional questions, please consult your BMW center or call 1-800-355-3515. ◀

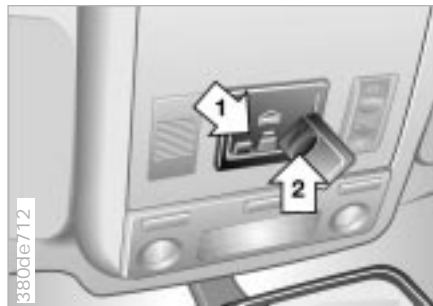

Programming

- 1 Channel keys
- 2 Indicator lamp
- 3 Receiver for programming

 Read and comply with the safety precautions on page 91. ◀

- 1 Ignition key position 2
- 2 For initial operation: Press and hold the two outer keys (1) until the indicator lamp (2) flashes. Release the keys. The three channel keys are cleared.

- 3 Hold the original hand-held transmitter toward the receiver (3) a maximum of 2 inches (5 cm) away.
- 4 Simultaneously press the transmitting key of the original hand-held transmitter (arrow 2) and the desired channel key of the BMW Universal Transmitter (arrow 1). Release both keys as soon as the indicator lamp flashes rapidly.
- 5 To program other original hand-held transmitters, repeat steps 3 and 4.

The corresponding channel key is now programmed with the signal of the original hand-held transmitter.

Programming a hand-held transmitter with change code

 Read and comply with the safety precautions on page 91. ◀

Consult the operating instructions for the individual device when programming the BMW Universal Transmitter. Read and comply with the following programming instructions for the use of the BMW Universal Transmitter with a change code system:

 A second person simplifies programming of the BMW Universal Transmitter. ◀

- 1 Program the BMW Universal Transmitter as described above under "Programming."
- 2 Press and hold the programming key on the receiver of the device for about two seconds or until the programming lamp on the device comes on.
- 3 Press the desired channel key of the BMW Universal Transmitter three times.



If you have additional questions, please consult your BMW center or call 1-800-355-3515. ◀

Clearing the channel keys



Read and comply with the safety precautions on page 91. ◀

Individual channel keys cannot be cleared. However, the three channel keys can be cleared together in the following manner:

- ▷ Press and hold the two outer channel keys of the BMW Universal Transmitter until the indicator lamp flashes, and then release the keys.

All channel keys are cleared.

User's information

Do not use this BMW Universal Transmitter with any garage door opener that lacks safety "stop" and "reverse" features as required by federal safety standards (this includes any garage door opener model manufactured before April 1, 1982).

This device complies with Part 15 of the FCC Rules. Operation is subject to the following two conditions: (1) This device may not cause harmful interference, and (2) This device must accept any interference that may cause undesired operation.

94 Integrated rear-seat equipment*



Fold the armrest out and open the cover by lifting the handle (arrow).

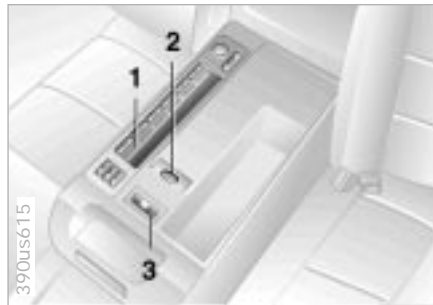

In order to operate certain functions from the rear passenger area as well, the corresponding controls are integrated in the center armrest.

The illustration shows the maximum possible number of controls, corresponding to a full range of optional equipment. Refer to the individual Operating Instructions for more detailed descriptions of the equipment.

- 1 Multi-information display for operation of the radio and onboard computer (with limited functional range)
- 2 Cigarette lighter
- 3 Electric rear window blind



Two beverage holders are provided in the lower section of the center armrest. Pull the handle outward to open (arrow).

Glove compartment



To open

Pull the handle and the lamp comes on.

To close

Fold the cover up.

To lock

Use one of the master keys. A master key is also required for unlocking.

 If you turn over only your door and ignition key for valet parking, for example (refer to page [30](#)), access to the glove compartment is not possible. ◀

 To prevent injury in the event of a crash, close the glove compartment immediately after use. ◀

Rechargeable flashlight*

Located on the left-hand side of the glove compartment.

It features integral overload-protection, so it can be left in its holder continuously.

 Be sure that the flashlight is switched off when it is inserted into its holder. Failure to comply with this precaution could lead to overcharging and damage. ◀

96 Storage compartments



The cover of the storage compartment on the inclined surface of the center console can be pushed open or closed (arrow). If your vehicle is equipped with a cassette holder*, open each cassette compartment by pressing the small button.

Storage compartment on center console between the front seats: To open, reach into the recess at the front and pull upward. If a cellular phone has been installed, this compartment is occupied by the phone.

You will find additional storage compartments in all of the doors as well as in the backrests of the front seats*.

Cellular phone*



Handsfree system*

For vehicles with a telephone hookup*, the trim cover for the handsfree speaker is located in the headliner in the area of the interior lamp.

For further information on the cellular phone: refer to the separate Operating Instructions.

Beverage holder*



Two holders for soft drinks have been provided in the center console below the controls for the automatic climate control, with two additional holders for rear passengers on the rear of the console, just below the vent outlets.

Press to open; push back inward to close.



To open

Press briefly in the direction indicated by the arrow.

To extinguish a cigarette, tap off the ash and gently press the tip into the funnel.



To empty

Open the lid and press down (arrow): You can now pull the ashtray upward for removal.

On vehicles equipped for nonsmokers, the insert is removed in the same way.

98 Cigarette lighter*



Press the cover panel for access (arrow), then push the lighter down.

Remove as soon as the lighter retracts.



Hold or touch the hot cigarette lighter by the knob only. Holding or touching it in other areas could result in burns.

The cigarette lighter remains operational when the ignition key has been removed. For this reason, children should never be left in the car unattended. ◀

Cigarette lighter socket

Suitable for attaching power supplies for flashlights, car vacuum cleaners, etc., up to a rating of approx. 200 watts at 12 volts. Avoid damage to the socket caused by inserting plugs of a different shape or size.

Ashtray, rear*



To open

Press the recess in the lid.

To empty

Press the edge of the cover (arrow). You can now pull the ashtray upward for removal.

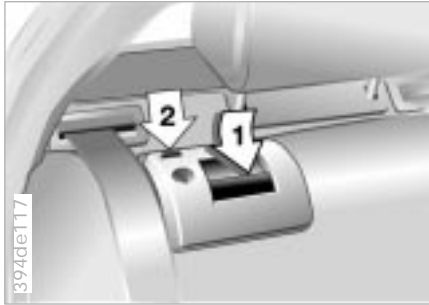

The rear backrest is divided into two sections, one-third and two-thirds of the seat respectively. For carrying longer objects, you can fold down either section of the backrest separately.

To open:
Reach into the recess and pull forward (arrow 1).

When you close the backrest, be sure that the catch engages securely. The red tab (arrow 2) must go fully down.



The middle belt has an additional small buckle.

- ▷ If you connect the two belt sections, you can use the middle belt as any normal 3-point belt
- ▷ It is easier to fold the rear seat backrest up and down if you unbuckle the belt (arrow).



You can lock each backrest in the rear seat with a master key.

This also prevents access to the luggage compartment from the interior of the vehicle when you turn over the door and ignition key (3) to someone else (refer to page 30). This is convenient for valet parking, for instance.

100 **Ski bag***

The ski bag allows you to transport up to four pairs of skis or two snowboards safely and conveniently.

With the length of the ski bag and the additional space in the luggage compartment, you can store skis with a length of up to 6.8 feet (2.10 meters). Because of the tapered shape of the bag, the ski bag can only accommodate two pairs of skis with a length of 6.8 feet (2.10 meters).



Installing the center armrest

Guide the armrest into position from above, then apply pressure until you hear it snap into position.



Be sure that the seat covers are not damaged by the side pins. ◀

Removing the center armrest

(Not required for vehicles with the through-loading system. Refer to page [102](#)).

- 1 Fold the center armrest completely down.
- 2 Loosen the trim from the upper Velcro® fastener and place it on the armrest.
- 3 Grasp the front of the armrest with one hand, then use your other hand to reach down behind the armrest and pull up sharply (arrow).

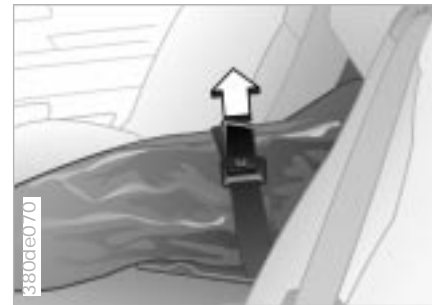
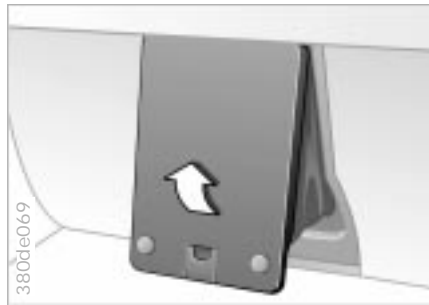

Loading

- 1 Press the release button (arrow 1):
The cover panel in the luggage compartment is unlocked.
- 2 Press the detent levers inward (arrow 2) and pull the cover forward.
- 3 Extend the ski bag between the front seats. The zipper provides convenient access to stored items. It may be opened to allow the ski bag to dry.

- 4 Use the magnetic retainers to attach the cover panel to the upper surface (metal surface below rear tray) of the luggage compartment.

Please be sure that the skis are clean before loading them into the bag. Take care to avoid damage from sharp edges.

-  Secure the bag's contents by tightening down the retaining strap at the buckle. ◀

To store the ski bag, perform the above steps in reverse sequence.

-  An unsecured ski bag could lead to loss of vehicle control and to personal injury in case of an accident. ◀

Cargo loading**With through-loading system**

- 1 Fold the center armrest down.
Loosen the trim from the upper Velcro® fastener and place it on the armrest.
- 2 Press button 1 downward and swing the cover forward.
- 3 Press knob 2: The cover in the luggage compartment is unlocked.

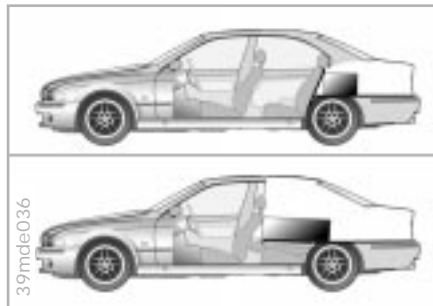
**Stowing cargo**

If you are transporting a load in your BMW:

- ▷ Load heavy cargo as far forward as possible – directly behind the backrests or the luggage compartment partition – and as low as possible.
- ▷ Cover sharp edges and corners.
- ▷ Do not pile objects higher than the top edge of the backrest.
- ▷ If you are transporting very heavy loads when the rear seat is not occupied, secure the outer safety belts in the opposite buckle.

**Securing the load**

- ▷ Secure smaller, light pieces with the luggage net or use draw straps* (refer to page 39).
- ▷ For large, heavy pieces, see your BMW center for load-securing devices*. The lashing eyes provided at the corners of the luggage compartment serve for mounting these load-securing devices.
- ▷ Read and comply with the information enclosed with the load-securing devices.

 Always position and secure the load correctly. If you do not, it can endanger the passengers during braking or evasive maneuvers.

Do not exceed the permissible gross weight and axle load (refer to page 174), otherwise the vehicle's operating safety is no longer assured and a violation of the laws of the road occurs.

Do not carry hard or heavy objects unsecured in the passenger compartment. If you do so, they may be projected through the air during braking and evasive maneuvers, thus endangering vehicle occupants. ◀

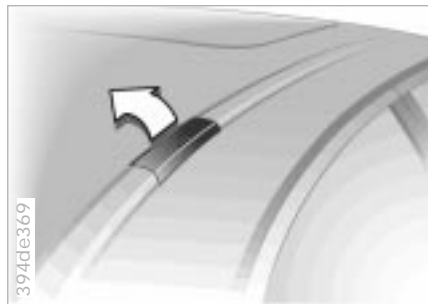

Anchors

Access to the anchors:

To open the cover (arrow) please use the tool included with the luggage system.

A special luggage system is available as an option for your BMW. Please comply with the precautions included with the installation instructions.

Roof-mounted luggage racks raise the center of gravity of the vehicle when they are loaded. For this reason, they exercise a major effect on the vehicle's handling and steering response.

You should therefore always remember not to exceed the approved roof weight, the approved gross vehicle weight or the axle weights when loading the rack. You will find the specifications under "Technical Data" on page 174.

Make sure that the load is not too heavy, and attempt to distribute it evenly. Always load the heaviest pieces first (on the bottom). Be sure that adequate clearance is maintained for raising the sliding/tilt sunroof.

Secure the roof luggage correctly and securely to prevent it from shifting or being lost during driving (danger to following traffic).

Drive smoothly and avoid sudden acceleration or braking. Do not corner at high speeds.

The roof load increases the aerodynamic resistance. Increased fuel consumption and additional stresses on the vehicle's body result from this.



Special operating instructions:

- Break-in procedures 106
- Driving notes 107
- Catalytic converter 108
- Antilock Brake System (ABS) 109
- Disc brakes 111
- Brake system 112
- Winter operation 113
- Power steering 115
- Cellular phones 115
- Radio reception 115

Wheels and tires:

- Tire inflation pressure 116
- Tire condition 116
- Tire replacement 117
- Tire rotation 118
- Wheel and tire combinations 119
- Winter tires 120
- Snow chains 121
- Approved wheel and tire specifications 122

Under the hood:

- Hood 123
- Engine compartment 124
- Washer fluids 126
- Washer nozzles 126
- Engine oil 127
- Coolant 129
- Brake fluid 130
- Vehicle Identification Number 131

Care and maintenance:

- The BMW Maintenance System 132
- Caring for your car 133
- Airbags 139
- Vehicle storage 139

Laws and regulations:

- Technical modifications 140
- OBD interface socket 141

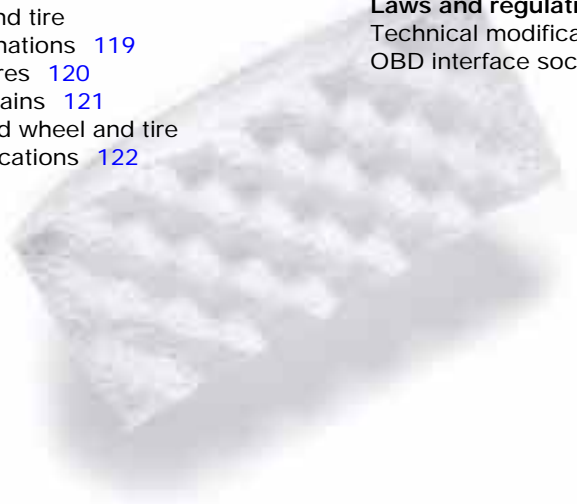
**Overview****Controls and features****Operation, care and maintenance****Owner service procedures****Advanced technology****Technical data****Index**

To ensure that your vehicle provides maximum economy throughout a long service life, we request that you observe the following suggestions:

 Because of its engineering design, the BMW M5 is an especially high-quality vehicle. To protect your own investment, we recommend that you follow the break-in instructions carefully. By doing so, you will create the basis for optimal service life of the vehicle. ◀

Engine and differential

Up to 1,200 miles (2,000 km):

Drive at varying engine speeds and road speeds, but do not exceed 5,500 RPM or 105 mph (170 km/h) during this period.

Obey all applicable local, state, provincial or federal maximum speed limits.

Do not depress the accelerator pedal to the full-throttle position.

Following the Break-In Inspection at 1,200 miles (2,000 km), you can gradually increase engine or road speeds.

You should also comply with these break-in procedures if the engine or differential is replaced later in the course of the vehicle service life.

Tires

Due to technical factors associated with their manufacture, tires do not achieve their full traction potential until an initial break-in period has elapsed. For this reason, drive with extra care during the initial 200 miles (300 km).

Obey all applicable local, state, provincial or federal maximum speed limits.

 When the vehicle is operated on wet or slushy roads, a wedge of water may form between the tire and the road surface. This phenomenon is referred to as aquaplaning, or hydroplaning, and can lead to partial or complete loss of traction, vehicle control and braking effectiveness. Reduce your speed on wet roads. ◀

Brake system

Approximately 300 miles (500 km) must elapse before the brake pads and rotors achieve the optimal pad-surface and wear patterns required for trouble-free operation and long service life later on.

To break in the separate parking brake drums, apply the parking brake lightly when coasting to a standstill (at a traffic signal, for instance), provided that traffic conditions allow you to do so. To avoid corrosion, repeat this procedure from time to time.

 The brake lamps do not come on when the parking brake is applied. Vacuum for the brake system servo unit on your BMW is available only when the engine is running. When you move the car with the engine shut off – when towing, for instance – substantially higher levels of pedal force will be required to brake the vehicle. ◀

Driving notes



Brakes:

Do not drive with your foot resting on the brake pedal. Even light but consistent pedal pressure can lead to high temperatures, brake wear and possibly even brake failure.

Aquaplaning:

A wedge of water can form between the tires and the road surface when you operate the vehicle on wet or slushy roads. This phenomenon is referred to as aquaplaning or hydroplaning. It is characterized by a partial or complete loss of contact between the tires and the road surface. The ultimate results are loss of steering and braking control.

Driving through water:

Do not drive through water that is deeper than 1 foot (30 cm). If you must drive through water accumulations up to that depth, drive only at walking speed. Driving at a faster speed could cause damage to the engine, the electrical systems and the transmission.

Rear parcel tray:

Do not place heavy or hard objects on the rear parcel tray. If you do so, they could pose a danger to vehicle occupants during a braking or evasive maneuver, or in a crash.

Clothes hooks:

When suspending articles of clothing from the hooks, be sure that they will not obstruct the driver's vision. Do not hang heavy objects on the hooks. If you do so, such objects could pose a danger during braking or evasive maneuvers. ◀

The catalytic converter reduces harmful exhaust emissions, and is designed for use with unleaded fuel only. Even minute quantities of lead would be enough to permanently damage both the catalytic converter and the system oxygen sensor.

To ensure efficient, trouble-free engine operation and avoid potential damage:

- ▷ Be sure to comply with the scheduled maintenance requirements.
- ▷ Fill the fuel tank well before it is empty.
- ▷ Do not attempt to start the engine by tow-starting. If you do so, unburned gasoline in the catalytic converter could ignite and cause severe damage. If you have starting problems, start the engine with an outside starting aid only. Refer to page [158](#).
- ▷ Avoid other situations in which the fuel is not burned or burns incompletely such as frequent or extended starter engagement or repeated start attempts in which the engine does not start. Stopping and restarting an engine which is running properly does not present a problem. Never allow the engine to run with any of the spark plug cables disconnected.



Be sure to comply with the instructions above to prevent unburned fuel from reaching the catalytic converter. Otherwise, the catalytic converter could respond by overheating, leading to serious damage.

Extreme temperatures occur at the catalytic converter on this and every catalyst-equipped vehicle. Heat shields are installed adjacent to some sections of the exhaust system. Never remove these shields; do not apply undercoating to their surfaces. When driving, standing at idle or when parking, take precautions to avoid contact between the hot exhaust system and easily flammable materials (grass, hay or leaves, for example). Such contact could lead to a fire, resulting in serious personal injury and property damage. ◀

Antilock Brake System (ABS)

The concept

ABS enhances active safety by helping to prevent the wheels from locking when the brakes are applied. This is done because locked wheels are dangerous. When the front wheels slide, the driver loses steering control over the vehicle. Traction loss at the rear wheels can cause the rear axle to break into an uncontrolled skid.

ABS is designed to meet two essential requirements during every brake application:

- ▷ to help provide vehicle stability
- ▷ to help maintain steering control and maneuverability – on all types of road surfaces (asphalt, concrete, mud, wet, snow, ice).

The system can achieve the shortest braking distances possible under most conditions (on straight-aways and in curves, on asphalt, ice, wet road surfaces, etc.).

Braking with ABS

The system becomes operative once the vehicle exceeds a speed of approx. 5 mph (8 km/h). The ABS is deactivated whenever the vehicle's speed drops back below approx. 2 mph (3 km/h). This means that the wheels can lock in the final phase of a brake application – a factor of no significance in actual practice.

If you are in a situation that requires full braking, you will exploit the full benefits of the ABS system if you apply maximum brake pressure ("panic stop"). Since the vehicle maintains steering responsiveness, you can avoid possible obstacles with a minimum of steering effort, despite the full brake application.

The ABS system's closed-loop control circuit cycles in fractions of a second. A pulsation at the brake pedal indicates to the driver that ABS is active, that is, that the vehicle is within its maximum braking range. In addition, a pulsation – a result of the control function cycles – indicates to the driver that vehicle speed should be reduced to adapt to road surface conditions when there is reduced traction and grip between tires and road surface (slippery road surface).

Always depress the brake pedal steadily and with consistent application force. Do not pump the brakes.

On road surfaces that have a loose surface layer on a firm base with good traction (on gravel or snow, for example), or when driving with snow chains, braking distances may be longer than with locked wheels. However, ABS continues to provide enhanced vehicle stability and steering response under these conditions.

Information for your safety

Not even ABS can suspend the laws of physics. ABS alone cannot prevent accidents when the brakes are applied without an adequate safety interval between vehicles, if the car is driven with excessive speed in curves, or if aquaplaning occurs. Responsibility for these types of situations remains in the hands (and at the feet) of the driver. You should never allow the added safety of ABS to lull you into a false sense of security, or mislead you into taking increased risks that could affect your own safety and that of others.

 Do not make any modifications to the ABS system. Service procedures on ABS are to be performed by authorized technicians only. ◀

In the event of a fault



If the ABS warning lamp in the instrument cluster lights up, refer to page 21. The brake system then reverts to conventional



operation as on vehicles without ABS. However, have the brake system checked by your BMW center as soon as possible. To prevent undetected defects and cumulative faults from adversely affecting the brake system, refer any problems to your BMW center at the earliest opportunity.

Disc brakes

Disc brakes furnish optimum deceleration and braking control and greater fade resistance under heavy use.

Infrequent driving, extended periods when the vehicle is parked, and driving conditions in which brake applications are less frequent all promote an increase in corrosion of the brake rotors and contamination of the brake pads. This occurs because the minimal application force that is required to clean the rotors is not reached between the pads and rotors.

If the brake rotors are corroded, they will tend to respond to braking with a pulsating effect which even extended application cannot correct.

 For your own safety: Use only brake linings that BMW has released for your particular vehicle model. BMW cannot evaluate non-approved brake pads to determine if they are suited for use, and therefore cannot ensure the operating safety of the vehicle if they are installed. ◀

Driving notes

While driving on wet roads or in heavy rain, it is a good idea to apply light pressure to the brake pedal every few miles or kilometers. Watch traffic conditions to ensure that this maneuver does not endanger other road users. The heat which is generated by the brake applications helps to dry the brake rotors and pads.

Maximum braking force is obtained while the wheels continue to rotate, peaking when the wheels remain on the verge of locking without actually doing so. ABS maintains this state automatically. If the ABS fails, you should revert to the staggered braking technique described on page 114.

Extended or steep mountain descents do not necessarily lead to an impairment in braking efficiency if you drive downhill in the gear that requires the least braking.

The engine's braking effectiveness can be increased even more by progressively shifting down – clear into first gear, if necessary.

If engine braking should prove to be inadequate, you should still avoid extended, continuous braking. Instead of maintaining low to moderate pressure over an extended period of time, you should decelerate the vehicle by applying more substantial force on the pedal (watch for following traffic). Pause before repeating the brake application. This staggered braking technique allows the brakes to cool in the intervals between active braking phases. This prevents overheating and ensures that full braking capacity remains available at all times.

 Do not coast with the clutch depressed, with the shift lever in neutral or with the engine shut off. The engine does not provide any braking effect with the transmission in neutral or with the engine shut off. Never allow floor mats, carpets or any other objects to protrude into the area around the accelerator, clutch and brake pedals and obstruct their movement. ◀

Dynamic Brake Control (DBC)*

If you apply the brakes rapidly, this system automatically generates maximum braking force boost and thus helps to achieve the shortest possible braking distance in "panic braking" situations. All of the benefits of the ABS system are exploited under these circumstances.

Do not reduce the pressure on the brake pedal for the duration of the brake application. When the brake pedal is released, the DBC is deactivated.



In the event of a malfunction, the yellow warning lamp comes on. Conventional braking efficiency is available without limitations. Have the system checked and repaired at your BMW center as soon as possible.



able.



Refer to the "Information for your safety" covering the ABS system on page 110. This information also applies in general for DBC. ◀

Brake system**Brake fluid level**

The warning lamp for the brake's hydraulic system comes on or the message "CHECK BRAKE FLUID" appears in the Check Control.



The brake fluid level is too low in the reservoir (refer to page 130).

If the brake fluid level is too low and brake pedal travel has become noticeably longer, there may be a defect in one of the brake system's hydraulic circuits.



Proceed to the nearest BMW center. Higher brake application pressure may be necessary under these conditions, and brake pedal travel may be significantly longer. Please remember to adapt your driving style accordingly. ◀

The warning lamp also comes on when the message "CHECK BRAKE LININGS" is displayed in the Check Control.

Brake linings

The message "CHECK BRAKE LININGS" appears in the Check Control:

The brake pads have reached their minimum pad thickness. Proceed to the nearest BMW center as soon as possible to have the pads replaced.



For your own safety: Use only brake linings that BMW has released for your particular vehicle model. BMW cannot evaluate non-approved brake pads to determine if they are suited for use, and therefore cannot ensure the operating safety of the vehicle if they are installed. ◀

Winter operation

The onset of winter is often accompanied by rapid changes in weather. Adaptations in driving style should be accompanied by preparations on the vehicle itself to ensure that your progress through the winter remains safe and trouble-free.

Coolant

Be sure that the coolant mixture contains the year-round ratio of 50:50 water and antifreeze/corrosion protection. This mixture provides protection against freeze-ups down to approx. $-34\text{ }^{\circ}\text{F}$ ($-37\text{ }^{\circ}\text{C}$). Replace the coolant every three years.

Locks

BMW door lock deicer can be used to free locks if they are frozen. This deicer also contains lubricant.

After using the deicer, treatment with BMW lock cylinder grease is recommended.

Rubber seals and components

Treat the rubber parts and weatherstripping on the doors, hood and luggage compartment lid with BMW rubber treatment or BMW Silicon Spray to prevent them from freezing.



A full range of car care products is available from your BMW center. ◀

Snow chains

Mount BMW snow chains* on winter tires only. Always mount snow chains in pairs and on the rear wheels only. Read and comply with the chain manufacturer's safety precautions. Do not exceed a maximum speed of 30 mph (50 km/h). To achieve maximum traction, we recommend that you deactivate the DSC system when snow chains have been mounted. Refer to page 76.

Starting off

When starting from a full stop in deep snow or for "rocking" the vehicle to free it, we recommend that you deactivate the DSC system. Refer to page 76.

Driving on low-traction road surfaces

Use smooth, gentle pressure to control the accelerator pedal. Avoid excessive engine speeds and shift to the next higher gear at an early point. Adapt your speed and driving style when approaching grades or slopes. Maintain an adequate distance between yourself and the car ahead.

Braking

Winter road conditions substantially reduce the amount of traction available between the tires and the road surface. The resulting increases in braking distance are considerable and should be kept in mind at all times.

ABS is intended to prevent the wheels from locking during brake applications, thus helping to maintain vehicle stability and steering response.

If the ABS system does not respond for any reason and the wheels lock:

Reduce the pressure on the brake pedal until the wheels just start to roll again while still maintaining enough force to continue braking. Following that, increase pedal pressure again. Reduce the pressure as the wheels lock, then reapply pressure. Repeat this braking method as necessary.

This type of staggered braking will reduce the braking distance, and the vehicle still remains responsive to steering.

You can then attempt to steer around hazards after you have reduced pressure on the brake pedal.



Do not shift down on slick road surfaces. Doing so could cause the rear wheels to lose traction and skid, resulting in the loss of vehicle control. ◀



Depress the clutch during hard braking on road surfaces that provide only poor or uneven traction. ◀

Skid control

Depress the clutch and release the accelerator pedal. Countersteer carefully and attempt to regain control of the vehicle.

Parking

Engage either 1st gear or reverse. Apply the parking brake whenever you park on inclined surfaces. In order to prevent the parking brake linings from locking due to frost or corrosion, dry them by gently applying the parking brake as the vehicle is coming to a stop. Make sure that following traffic is not endangered.



The brake lamps do not light up when the parking brake is applied. ◀

Power steering

If there is a change in steering behavior, for instance greater steering effort or if steering becomes lighter as speed increases:

Contact your BMW center immediately for an inspection.



If the power steering fails, increased effort will be required to steer the vehicle. ◀

Cellular phones*

Mobile communications systems (cellular phone, radio, etc.) are only allowed a power output of up to 10 watts. Mobile communications devices not specifically designed for use in your car may trigger malfunctions in the operation of your vehicle. BMW can neither test nor assume responsibility for every individual product being offered on the market. We recommend that you consult your BMW center before purchasing any device of this kind.

To ensure that your BMW continues to provide reliable and trouble-free operation, do not use a cellular phone or other radio device with an antenna located inside the passenger compartment. The antenna should always be mounted on the outside of the vehicle.



Before loading the vehicle on a car-carrier train or driving it through a car-wash, remove the antenna. ◀

Radio reception

The reception and sound quality obtained from mobile radios varies according to a variety of factors, including the broadcast range of the transmitter and the directional orientation of the antenna.

Interference factors such as high-tension power lines, buildings and natural obstructions can all lead to unavoidable reception interference, regardless of how well the vehicle's sound system is operating. Climatic factors such as intense solar radiation, fog, rain and snow can also interfere with reception.

Cellular phones without formal BMW approval can also generate interference. This phenomenon assumes the form of a low-pitched hum emanating from the speaker system.

Please refer to the supplementary Owner's Manual provided with your sound system for detailed information on its use.

Information for your safety

The factory-approved radial tires are matched to the car and have been selected to provide optimum safety and driving comfort on your car.

It is not merely the tire's service life, but also driving comfort and – above all else – driving safety that depend on the condition of the tires and the maintenance of the specified tire pressure.

Incorrect inflation pressure is a frequent cause of tire damage. It also significantly influences the roadholding ability of your BMW.

 Check tire inflation pressures regularly – at least every two weeks and before beginning a longer trip. If this is not done, incorrect tire pressures can cause driving instability and tire damage, ultimately resulting in accidents. ◀

Tire condition**Tire tread – Tire damage**

Inspect your tires frequently for tread wear, signs of damage and for foreign objects lodged in the tread. Check the tread depth.

Tread depth should not be allowed to go below 0.12 inches (3 mm), even though the legally specified minimum tread depth is 0.063 inches (1.6 mm). At a tread depth of 0.063 inches (1.6 mm), tread depth indicators (arrow) in the tread-groove base indicate that the legally-permissible wear limit has been reached. Below 0.12 inches (3 mm) tread depth, there is an increased risk of aquaplaning, even at relatively moderate speeds and with only small amounts of water on the road.



Do not drive on a deflated (flat) tire. A flat tire greatly impairs steering and braking response, and can lead to complete loss of control over the vehicle. Avoid overloading the vehicle so that the permitted load on the tires is not exceeded. Overloading can lead to overheating and increases the rate at which damage develops inside the tires. The ultimate result can assume the form of a sudden air loss.

Unusual vibrations encountered during normal vehicle operation can indicate tire failure or some other vehicle defect, as can variations in normal vehicle response, such as a pronounced tendency to pull to the left or right. Should this occur, respond by immediately reducing your speed and carefully proceeding to the nearest BMW center or professional tire center, or having the vehicle towed in to have it and its tires inspected.

Tire damage (up to and including blow-outs) can endanger the lives of both the vehicle occupants and other road users. ◀

Tire replacement

To maintain good handling and vehicle response, use only tires of a single tread configuration from a single manufacturer. BMW tests and approves wheel/tire combinations. Refer to page [122](#).

DOT Quality Grades

Treadwear

Traction AA A B C

Temperature A B C



All passenger car tires must conform to Federal Safety Requirements in addition to these grades. ◀

Treadwear

The treadwear grade is a comparative rating based on the wear rate of the tire when tested under controlled conditions on a specified government test course.

For example, a tire graded 150 would wear one and one-half (1 1/2) times as well on the government course as a tire graded 100. The relative performance of tires depends upon the actual conditions of their use, however, and may depart significantly from the norm due to variations in driving habits, service practices and differences in road characteristics and climate.

Traction

The traction grades, from highest to lowest, are AA, A, B and C. Those grades represent the tire's ability to stop on wet pavement as measured under controlled conditions on specified government test surfaces of asphalt and concrete. A tire marked C may have poor traction performance.



The traction grade assigned to this tire is based on straight-ahead braking traction tests, and does not include acceleration, cornering, hydroplaning, or peak traction characteristics. ◀

Temperature

The temperature grades are A (the highest), B and C, representing the tire's resistance to the generation of heat and its ability to dissipate heat when tested under controlled conditions on a specified indoor laboratory test wheel.

Sustained high temperature can cause the material of the tire to degenerate and reduce tire life, and excessive temperature can lead to sudden tire failure. The grade C corresponds to a level of performance which all passenger car

tires must meet under the Federal Motor Vehicle Safety Standard No. 109. Grades B and A represent higher levels of performance on the laboratory test wheel than the minimum required by law.



The temperature grade for this tire is established for a tire that is properly inflated and not overloaded. Excessive speed, underinflation, or excessive loading, either separately or in combination, can cause heat buildup and possible tire failure. ◀

Uniform Tire Quality Grading

Quality grades can be found where applicable on the tire sidewall between tread shoulder and maximum section width. For example:

Treadwear 200 Traction AA
Temperature A



Do not use retreaded tires. Driving safety may be impaired by their use. This is due to the possible variations in casing structures and, in some cases, to their extreme age – factors that can lead to a decrease in their durability. ◀

Tire age

The date on which the tire was manufactured is indicated by the code on the sidewall:

DOT ... 328 indicates that the tire was manufactured in Week 32 of 1998.

BMW recommends the replacement of all tires when the tires are no more than 6 years old, even if a tire life of 10 years is possible.

Tire rotation

Between the axles

The tread wear patterns at the front end differ from those at the rear – the actual patterns will vary according to individual driving conditions. In the interests of safety and maintaining optimal handling characteristics, tire rotation is not recommended.

When considering the potential economic benefits of interaxle tire rotation, you must decide whether the expense of having the tires rotated is likely to be amortized during the anticipated extension in tire life. In principle, interaxle tire rotation should be performed at short intervals, with a maximum of 3,000 miles (5,000 km). Consult your BMW center for more information.

Should you decide to rotate the tires, it is essential that you comply with the following:

Rotate tires on the same side only, since braking characteristics and road grip could otherwise be adversely affected.

Following rotation, correct the tire inflation pressure.



If different tire sizes are mounted on the front and rear axles (refer to page 122), the wheels may not be rotated from one axle to the other. ◀

Wheel and tire combinations

The right choice

Use only tires approved by BMW. Refer to page 122.

Due to the high speeds this vehicle can reach, the use of specific brands, specifications and sizes is mandatory.

Consult any BMW center for details.

Comply with local/national regulations.

 The correct wheel-tire combination affects different systems such as ABS, DSC, RDW.

The function of these systems is impaired if improper wheel-tire combinations are used.

For this reason, use only tires of the same brand and tread pattern. In the event of a flat tire, for example, remount the approved wheel-tire combination as soon as possible. ◀

Codes on the tires and wheels

The tire codes will aid you in selecting the correct tire.

Codes on radial tires:

Example: 225/60 R 15 96 W

Nominal width in mm ———— 225

Aspect ratio in % ———— 60

Belt rating code for radial ———— R

Rim diameter in inches ———— 15

Load rating (not for ZR tires) ———— 96

Speed rating (before R on ZR tires) ———— W

The speed rating indicates the approved maximum speed for the tire.

Summer tires:

S = up to 112 mph (180 km/h)
 T = up to 118 mph (190 km/h)
 H = up to 130 mph (210 km/h)
 V = up to 149 mph (240 km/h)
 W = up to 167 mph (270 km/h)
 Y = up to 186 mph (300 km/h)
 ZR = over 149 mph (240 km/h)

Winter tires:

Q M+S = up to 100 mph (160 km/h)

T M+S = up to 118 mph (190 km/h)

H M+S = up to 130 mph (210 km/h)

Codes stamped on light-alloy wheels:

7 J x 15 H 2

Rim width in inches ———— 7

Code letter for flange type ———— J

Symbol for full-drop center rim ———— x

Rim diameter in inches ———— 15

Hump on the 2 rim shoulders ———— H 2

Protect valve stems and valves from dirt by using screw-on valve stem caps. Dirt in the valves frequently leads to slow leaks.

Choosing the right tire

BMW recommends winter tires (M+S radial tires) for driving in adverse winter road conditions. While tires known as all-season tires (M+S designation) provide better winter traction than summer tires with load ratings H, V, W and ZR, they generally do not achieve the performance of winter tires.

For safe tracking and steering response, install winter tires made by the same manufacturer having the same tread configuration on all four wheels.

Mount only winter tires approved by BMW. Any BMW center will be glad to provide you with information on the best winter tires for your particular driving conditions.



Never exceed the maximum speed for which the tires are rated.

Unprofessional attempts by laymen to service tires can lead to damage and accidents.

Have this work performed by skilled professionals only. Your BMW center will be glad to assist you with both their expertise and the proper equipment for your vehicle. ◀

Tire condition, tire pressure

Winter tires display a perceptible loss in their ability to cope with winter driving conditions once the tread wears to below 0.16 inches (4 mm), and should thus be replaced.

Comply with the specified tire inflation pressures – and be sure to have the wheel and tire assemblies balanced every time you change the tires.

Storage

Store tires in a cool, dry place, away from light whenever possible. Protect the tires against contact with oil, grease and fuel.

Snow chains*

The use of narrow-link BMW snow chains on winter tires is approved only in pairs and only on the rear wheels. Comply with all manufacturer's safety precautions when mounting the chains.



It is not possible to mount snow chains with 18-inch wheels and tires. ◀

122 **Approved wheel and tire specifications**

Tire specifications	Light-alloy wheels
BMW M5	
Summer	
Front: 245/40 ZR 18	8Jx18AH2
Rear: 275/35 ZR 18	9.5Jx18AH2
Winter (M+S)	
235/45 R 17 94 H	8Jx17AH2

Observe the specifications for tires and wheels in the vehicle's manuals. If sizes not approved by the manufacturer are mounted, an entry in the vehicle's documents may be necessary.

Snow chains*

It is not possible to mount snow chains with 18-inch wheels and tires.



The use of rims and lug bolts that do not meet the specifications of the original factory-installed equipment will affect the safe operation of your vehicle and may cause an accident and personal injury.

Never mix tires of different design, such as steel-belted radials with radial bias belted or bias-ply tires, etc. Mixing tire types will adversely affect roadholding and can lead to loss of vehicle control. ◀



To unlock

Pull the lever located under the left-hand side of the instrument panel.

⚠ Do not work on your vehicle without appropriate skills. Always switch off the engine and allow it to cool down before working in the engine compartment. Always disconnect the battery before working on any electrical systems or equipment, especially when these are located within the engine compartment. Comply with all applicable instructions and warnings. Failure to work in an informed, professional manner when servicing components and materials constitutes a safety hazard for vehicle occupants and other road users. If you are not familiar with the guidelines, please have the operations performed by your BMW center. ◀



To open

Pull the release handle and open the hood.



To close

Allow the hood to fall from a height of about 4 inches (10 cm) so that it audibly engages.

⚠ To avoid injuries, be sure that the travel path of the hood is clear when it is closed, as with all closing procedures. If it is determined that the hood is not completely closed while driving, stop immediately and close it securely. ◀

124 Engine compartment

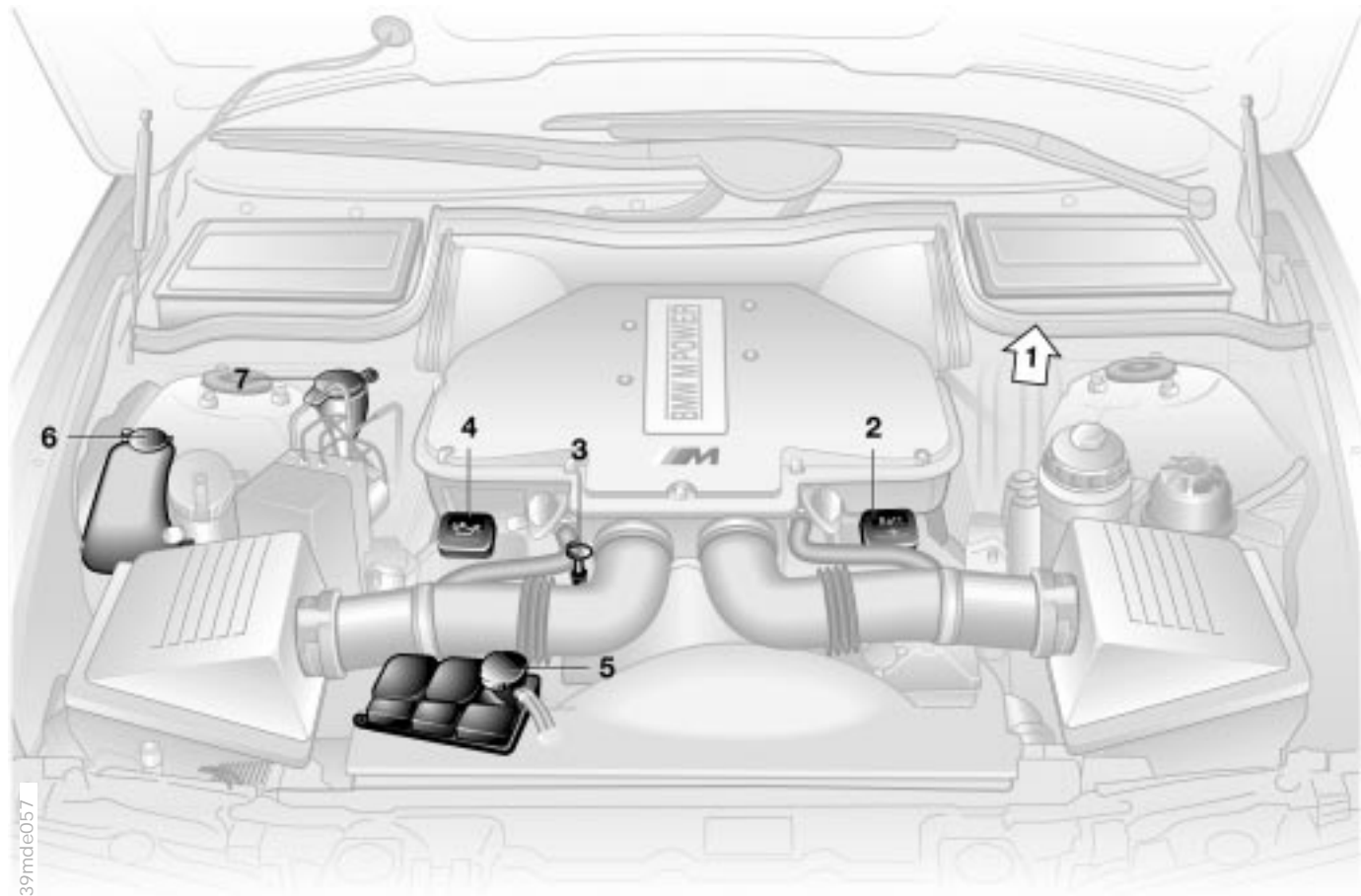

Engine compartment

- 1 Reservoir for brake fluid (under the housing of the microfilter) [130](#)
- 2 Auxiliary terminal for jump starting [158](#)
- 3 Engine oil dipstick [127](#)
- 4 Engine oil filler neck [127](#)
- 5 Coolant expansion tank [129](#)
- 6 Reservoir for the intensive-cleaning system [126](#)
- 7 Reservoir for the windshield and headlamp washer system* [126](#)



Headlamp* and windshield washer system

Capacity in US quarts (liters).

Windshield washer:

Approx. 3.7 US quarts (3.5 liters)

With headlamp-washing system:

Approx. 6.3 US quarts (6.0 liters).

Fill with water and – if required – with a washer antifreeze (according to manufacturer's recommendations).



We recommend that you mix the washer fluid before adding it to the reservoir. ◀

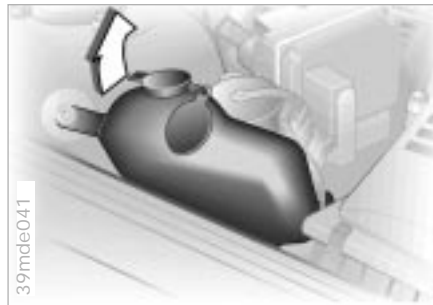

Intensive-action washer reservoir*

Capacity approx. 1.1 US quarts (1.0 liters).

Fill with intensive-action washer fluid. It resists freezing to approx. -17°F (-27°C) and is available from your BMW center.



Antifreeze agents or intensive-action washer fluids for the washer systems are highly flammable. For this reason, keep them away from sources of flame and store them only in their original containers. Store them so that they are inaccessible to children. Comply with the instructions on the containers. ◀

Washer nozzles

Windshield washer

The spray from the nozzles should be directed so as to ensure effective cleaning, even at high speeds. Use a needle to adjust the nozzles as required or have them adjusted at your BMW center.

Headlamp washer system

Have the nozzles adjusted by your BMW center as required.

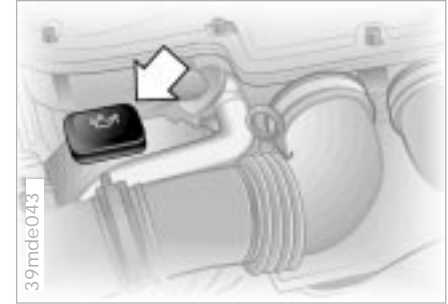
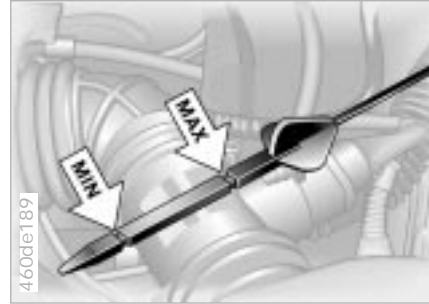
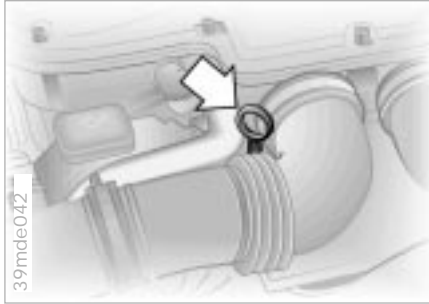

Checking oil level

- 1 Park the vehicle on a level surface.
- 2 Allow the engine to run at operating temperature for at least 15 seconds at idle, then shut it off.
- 3 After approx. one minute, pull the dipstick out and wipe it off with a clean lint-free cloth, paper towel, or similar material.
- 4 Push the dipstick all the way into the guide tube and pull it out again.
- 5 The oil level should be between the two graduations on the dipstick.

As with fuel economy, oil consumption is directly influenced by your driving style and vehicle operating conditions.

The oil volume between the two marks on the dipstick corresponds to approx. 1.1 US quarts (1 liter). Do not fill beyond the upper mark on the dipstick. Excess oil will damage the engine.

To add oil

Wait until the level has dropped to just above the lower mark before adding oil. However, do not wait until the oil level drops below the lower mark.

 BMW engines are designed to operate without oil additives; the use of additives could lead to damage in some cases. This is also true for the manual transmission, the differential, and the power steering system. ◀

Specified engine oils

The quality of the engine oil is extremely important for the function and service life of an engine. Based on extensive testing, BMW recommends only certain types of engine oil.

Approved are:

- ▷ Castrol Formula RS SAE 10W60
- ▷ Veedol Synthetic Z SAE 10W60

If you are unable to obtain one of these oils, you may use small volumes of synthetic oil for topping up between oil changes. Only use oils with the specification API SH or higher.

 Ask your BMW center for details concerning the specific "BMW High Performance Synthetic Oil" or "special oils" which are suitable for topping up. ◀

You can also call BMW of North America at 1-800-831-1117 or visit this website: www.bmwusa.com to obtain this information.

Viscosity ratings

Viscosity is the oil flow rating as established in SAE classes.

The selection of the correct SAE class depends on the climatic conditions in the area where you typically drive your BMW.

If an approved oil is used, temperatures under the lower limit of 5 °F (-15 °C) are permitted for short periods. However, the engine may not be as easy to start from cold.

If the vehicle is to be operated for long periods at temperatures below 5 °F (-15 °C), the oil must be replaced with synthetic oil, viscosity class 5W30.

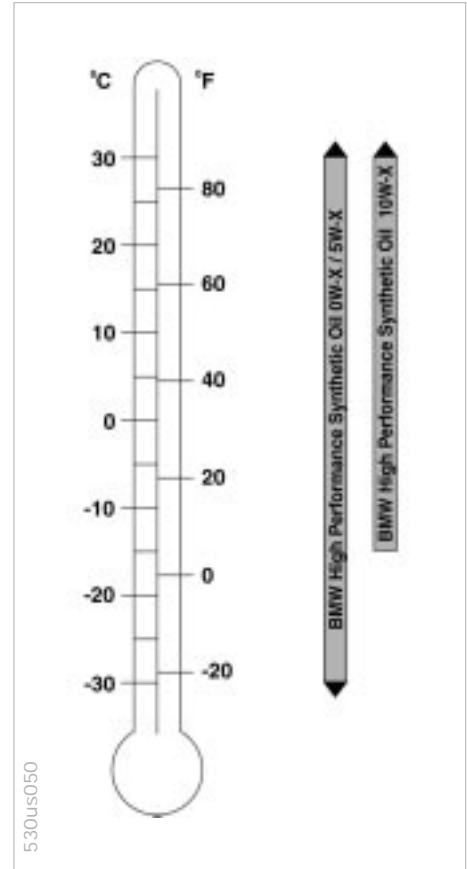

Engine oil

 Always observe all environmental protection guidelines and regulations when disposing of used oil. ◀

Recommendation: Have the oil changed by your BMW center only.

 Continuous exposure to used oil has caused cancer in laboratory testing.

For this reason, any skin areas that come into contact with oil should be thoroughly washed with soap and water.

Always store oils, grease and similar materials so that they are inaccessible to children. Comply with warning labels and information on containers. ◀

Coolant

 Do not add coolant to the cooling system when the engine is hot. If you attempt to do so, escaping coolant can cause burns.

To avoid the possibility of secondary damage, never use anything other than factory-approved, nitrite and amino-free extended-duty antifreeze with corrosion inhibitor. Your BMW center is familiar with the official specifications.

Antifreeze and anticorrosion agents are hazardous to health. You should always store them in their original container and in a location which is out of reach of children. Extended-duty antifreeze with corrosion inhibitor contains the flammable substance ethylene glycol. For this reason, do not spill antifreeze with corrosion inhibitor on hot engine parts. It could ignite and cause serious burns. ◀

 Comply with the applicable environmental laws regulating the disposal of extended-duty antifreeze with corrosion inhibitor. ◀

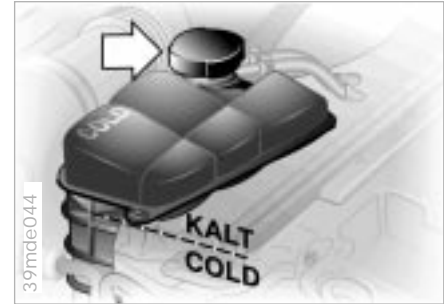

Checking coolant level

Correct coolant level when the engine is cold (approx. 68 °F/20 °C): Visible within the transparent expansion tank, no higher than the "COLD" mark.

Adding coolant

Wait until the engine cools before removing the cap from the expansion tank. The needle of the coolant gauge in the instrument cluster must be located in the blue zone; otherwise, there is a danger of scalding.

- 1 Turn the cap counterclockwise slightly in order to allow accumulated pressure to escape. Then open.
- 2 If the coolant is low, slowly add coolant until the correct level is reached – do not overfill.

The coolant is a mixture of water and extended-duty antifreeze with corrosion inhibitor. Always maintain the prescribed all-season 50:50 mixture ratio for year-round protection against internal corrosion. No other additives are required.

Replace the coolant every three years.

Brake fluid**Brake fluid level**

If the indicator lamp for the brake hydraulic system appears or if the "CHECK BRAKE FLUID" message appears in the Check Control: The brake fluid level is too low in the reservoir.



The brake fluid reservoir is located under the microfilter housing on the driver's side of the car. For adding brake fluid or for determining and correcting the cause of brake fluid loss, consult your BMW center. Your BMW center is familiar with the specifications for factory-approved brake fluids (DOT 4).

Brake fluid loss may result in extended brake pedal travel. If this occurs, refer to the information on page [112](#).



Brake fluid is hygroscopic, that is, it absorbs moisture from the air over time. In order to ensure the safety and reliability of the brake system, have the brake fluid changed every two years by an BMW center. Refer also to the Service and Warranty Information Booklet (US models) or the Warranty and Service Guide Booklet (Canadian models). Brake fluid is toxic and damages the vehicle's paint. You should always store it in its original container and in a location which is out of reach of children. Do not spill the fluid and do not fill the brake fluid reservoir beyond the "MAX" mark. The brake fluid could ignite upon contact with hot engine parts and cause serious burns. ◀



Comply with the applicable environmental laws regulating the disposal of brake fluid. ◀



In the engine compartment, stamped on the right-hand strut dome (arrow) and on the upper edge of the instrument panel on the left-hand side.



The BMW Maintenance System has been designed as a reliable means of providing maximum driving and operating safety – and as cost-effectively as possible for you.

Please keep in mind that regular maintenance is not only necessary for the safety of your vehicle, but also plays a significant role in maintaining the resale value of the vehicle.

Service Interval Display

Advanced technology is employed to calculate the optimal maintenance intervals, which are then indicated in the Service Interval Display. While conventional systems rely solely on distance traveled to determine when service is due, the BMW Maintenance System

began many years ago to take the actual conditions under which the vehicle is driven into consideration.

From the point of view of maintenance, 62,000 miles (100,000 km) accumulated in short-distance urban driving are not the equivalent of the same distance covered at moderate speeds in long-distance highway travel.

The BMW Maintenance System includes the Engine Oil Service and Inspections I and II.

Determining the maintenance intervals according to the actual vehicle driving loads on the car covers every kind of operating situation. However, even those who drive only short distances – significantly less than 6,200 miles (10,000 km) annually – should have the engine oil changed at least every 2 years since oil deteriorates over time, regardless of use.

Service and Warranty Information Booklet (US models)/Warranty and Service Guide Booklet (Canadian models)

For additional information on maintenance intervals and procedures, please refer to the Service and Warranty Infor-

mation Booklet (US models) or the Warranty and Service Guide Booklet (Canadian models).

As a precaution against rust, it might be a good idea to have the body checked for damage from rocks or gravel at the same time, depending upon operating conditions.



Have your BMW center perform maintenance and repairs.

Your BMW center is always informed on the latest maintenance work and repair techniques and equipped with the required special tools. In addition, checking parts known from experience to be subject to wear is a permanent part of the maintenance specifications. Be sure that all maintenance work is confirmed in the Service and Warranty Information Booklet (US models) or the Warranty and Service Guide Booklet (Canadian models). These entries are your proof that the vehicle has received regular maintenance. They are also a requirement for warranty claims. ◀

Caring for your car

Washing your car

You can have your new BMW washed in an automatic car wash. Car wash systems that do not employ brushes are preferable.

Wipe away tough dirt and loosen and remove dead insects before washing the car.

To prevent spots, do not wash the car when the hood is still warm, or immediately after and during exposure to strong sunlight.

When using an automatic car wash, be sure that:

- ▷ The car wash system is suited for the dimensions of your vehicle.
- ▷ No damage will occur on vehicles with attached body accessories (such as spoilers or antennas). Consult the car wash operator if necessary.
- ▷ The wheels and tires of your vehicle cannot be damaged by the conveyance devices of the car wash system.
- ▷ The vehicle is cleaned with minimum brush pressure, and that ample water is available for washing and rinsing.

Vehicles with rain sensor*:

Clean the windshield regularly. Wax from automatic car washes or insects, for example, can cause malfunctions in the function of the rain sensor.



Turn the rain sensor off in automatic car washes. If you do not, damage may occur if the wipers switch on unintentionally. ◀

Parts of the car that are inaccessible to the automatic washer – such as door sills, door and hood edges, etc. – should be cleaned by hand.

In the winter months, it is especially important to be sure that the car is washed on a regular basis. Large quantities of dirt and road salt are difficult to remove, and they also cause damage to the vehicle.



If spray wands or high-pressure washers are used, be sure to maintain an adequate distance between the spray source and the vehicle's surface. Inadequate distance and excessive pressure can damage or weaken the finish, making it more susceptible to subsequent attack. In addition, moisture could penetrate to vehicle components, leading to long-term damage. ◀



- When cleaning the headlamps, please observe the following:
- ▷ Do not clean by wiping with a dry cloth. Never use abrasives or strong solvents to clean the covers.
 - ▷ Remove dirt and contamination (such as insects) by soaking with BMW Car Shampoo and then rinsing with plenty of water.
 - ▷ Always use a deicer spray to remove accumulated ice and snow – never use a scraper. ◀



After washing the car, apply the brakes briefly to dry them. Braking efficiency might otherwise be reduced by the moisture and the brake rotors could also be corroded. ◀

Exterior finish

To provide effective corrosion protection, multilayer paintwork is applied at the factory. Cathaphoretic immersion priming techniques are supplemented using special body-cavity protectants, with the application of specially-developed and extensively tested materials. A layer of flexible PVC is first applied to the undercarriage. Following this, a comprehensive undercoating treatment with a wax-based protectant is applied. Regular maintenance makes an important contribution to maintaining the safety and value of your vehicle.

Increasing awareness of the effects of harmful environmental factors on vehicle finishes have led paint and vehicle manufacturers to initiate ongoing programs designed to further improve the durability of their finishes. Despite this, environmental factors that occur locally or regionally can have negative effects on the finish of your vehicle. These should guide you in determining the frequency and extent of your efforts to maintain the vehicle finish.

Depending upon material and type of impact (perforation of paint layer), physical stresses from sand, road salt, gravel, etc., can cause corrosion to start extending beneath the finish, starting at the point of impact.

Road dirt, tar spots, dead insects, animal droppings (strong alkali effect) and tree excretions (resins and pollen) all contain substances capable of causing damage if they are allowed to remain on the finish of your car for any period of time (spots, etching, flaking, separation in the top coat).

In industrial areas, deposits of flue dust, lime, oily soot, precipitation containing sulfur-dioxide (acid rain) and other environmental pollutants will damage the car's finish unless adequate care is provided – even though this is generally limited to the outside horizontal surfaces.

In coastal regions, high levels of atmospheric salt and humidity promote corrosion.

In tropical zones, temperatures of over 105 °F (40 °C) in the shade prevail, in addition to heavy ultraviolet radiation and high humidity. Under those conditions, light paints can reach temperatures up to 175 °F (80 °C) and dark paints up to 250 °F (120 °C).

Caring for your car

Caring for the vehicle finish

Regular washing is a preventive measure against long-term effects from substances that are harmful to the vehicle's finish, especially if you drive your vehicle in areas with high levels of air pollution or aggressive natural substances (tree resins, pollen).

Nevertheless, you should immediately remove especially aggressive substances. Failure to do so can lead to changes in the paint's chemical structure or to discoloration. Gasoline spilled during refueling, oil, grease and brake fluid should always be cleaned away immediately, as should bird droppings (finish damage).

Any contamination remaining on the surface of the vehicle will be especially conspicuous after washing. Use cleaning fluid or alcohol with a clean cloth or cotton pad to remove. Remove tar spots with tar remover. After cleaning, the affected areas should be waxed to ensure continued protection.

 Use cleaning and car-care products that you can obtain at your BMW center. ◀

Waxing your car

Protect the finish using carnauba or synthetic-based waxes only.

The best way to determine when the finish needs to be waxed is by noting when water stops beading on the surface.

You can use a glass cleaner to remove any wax or silicone that may have been left on the windows during waxing.

 Use cleaning and car-care products that you can obtain at your BMW center. ◀

Paint damage

You can touch up small areas of paint damage with a BMW spray paint or a BMW touchup stick.

The paint color code for your car is provided on a sticker located on the right hand side under the hood and on the first page the Service and Warranty Information Booklet (US models) or of the Warranty and Service Guide Booklet (Canadian models).

Damage caused by flying stones, scratches, etc., must be touched up without delay to prevent rust from forming.

If corrosion has started to form in an area with paint damage, remove all rust and clean the area. Then prime the area with a BMW Primer Stick. Finally, apply the finish coat. Wait a few days, then polish the repaired area. Finish by applying a wax preservative.

More extensive paint damage should be professionally repaired in accordance with the manufacturer's instructions. Your BMW center uses original BMW finish materials in accordance with factory-approved repair procedures.

Window care

You can use window and glass cleaner to clean inside window surfaces and mirrors without smearing and streaking. Never use polishing pastes or abrasive (quartz) cleansers on mirror lenses.

 When caring for break-resistant security glass*, observe the following instructions:

The inner surface of the side windows is coated with a plastic film. For this reason, do not affix any decals or adhesive stickers on the inside of these windows unless they are to be placed there permanently. Wash the glass with clean water. If necessary, you may add a commercially-available mild household cleaner. Do not use abrasive cleaners. If the windows are fogged or iced over, treat them with an anti-misting cloth or a deicer spray – do not use an ice scraper. ◀

Clean the wiper blades with soapy water. The wiper blades should be replaced twice a year, before and after the cold season.

 Use only wiper blades approved by BMW. ◀

Caring for your car

Caring for other vehicle components and materials

Light-alloy wheels should be treated with alloy wheel cleaner, especially during the winter months. However, do not use aggressive products containing acids, strong alkalis or abrasives. Do not use steam cleaners operating at temperatures above 140 °F (60 °C). Follow the manufacturer's instructions.

If your vehicle has chrome parts* such as the window frames and door handles, clean these parts carefully with ample clean water after driving on roads that have been salted. Add a shampoo supplement if desired. Use chrome polish as an additional treatment.

Plastic components, vinyl upholstery, headliners, lamp lenses, the clear cover of the instrument cluster and components with a sprayed dull black surface can be cleaned with water (add plastic shampoo as required). Do not allow moisture to soak through the seats or headliner. Never use solvents such as lacquer thinner, heavy-duty grease remover, fuels, etc.

Rubber components should be cleaned with water only; a rubber treatment or silicone spray may also be applied.

The safety belts should be cleaned with a mild soap and water solution without being removed from the car. Never attempt chemical or dry cleaning, as damage to the belt fabric could result.

After cleaning, never allow the inertia reel to retract the belts until they are completely dry. Dirty safety belts prevent the inertia reel mechanism from retracting the strap properly, and thus constitute a safety hazard.

Heavily soiled floor carpets and mats* can be cleaned with an interior cleaner. The floor mats can be removed from the vehicle for cleaning.

Please use only a damp cloth to clean wooden fascia panels and components. Follow up by drying with a soft cloth.



Use cleaning and car-care products that you can obtain at your BMW center. ◀

Leather care

The leather upholstery* used by BMW is a natural product of the highest quality, processed using state-of-the-art methods to ensure that it will maintain its high quality for years to come, provided that it is properly cared for.

Because this product is manufactured using natural materials, you must make allowance for its special characteristics as well as for the peculiarities of its use and care.

Regular periodic cleaning and care are essential, as dust and road dirt act as abrasives in the pores and creases of the material. This leads to wear spots and premature brittleness on the surface of the leather. We therefore suggest that you clean the leather with a vacuum cleaner or dust cloth at frequent intervals.

For cleaning use BMW leather cleaning foam.

Since dirt and grease gradually attack the protective layer of the leather, the cleaned surfaces should be treated with BMW leather care agent. This also acts as an antistatic agent.

For protection against dampness or moisture, treat the leather with a BMW impregnating agent.

We recommend that you perform this procedure twice a year on leather exposed to normal use.

Spills should be wiped up immediately.

If the upholstery will be exposed to intense sunlight or if the vehicle is to be stored for an extended period, cover all leather surfaces (or better yet, cover the windows) to prevent fading.



Use cleaning and car-care products that you can obtain at your BMW center. ◀



Cleaning agents can contain substances that are dangerous or pose health risks. For this reason, always read and comply with the warnings and danger notices on the package.

Open the doors or windows on your vehicle when cleaning the interior. Never clean your vehicle with solvents or other materials not specifically intended for this application. ◀

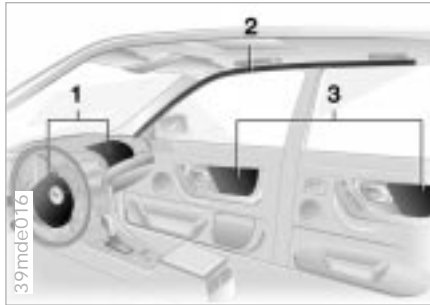

- 1 Front airbags for driver and front passenger
- 2 Side Impact Head Protection System (front)
- 3 Side airbags (front and rear side*)

Important safety notices

 Do not remove the airbag restraint system's gas generator. Testing and servicing are to be performed only by trained technicians. In the event of the air bag restraint system malfunctioning, being deactivated or triggered (in response to an accident), consult an BMW center only for the performance of any removal and service operations.

Do not modify or tamper with either the wiring or the individual components in the airbag system. This includes the padded steering wheel hub, the instrument panel, the side trim panels of the front or rear doors and the roof pillars or the sides of the headliner. Never apply adhesive materials to these components or cover or modify them in any way. Do not remove or dismantle the steering wheel yourself. To ensure compliance with official safety regulations, have an BMW center dispose of airbag generators. Unprofessional attempts to service the system could lead to failure in an emergency or undesired airbag activation, either of which could result in personal injury. ◀

Consult your BMW center regarding special procedures if you intend to store the vehicle for more than three months.

140 Technical modifications

Any BMW center will be glad to inform you of the advisability, legal requirements and factory recommendations regarding technical modifications on your vehicle. For this purpose, the BMW center will require the Vehicle Identification Number and, in some cases, also the engine number.

Light-Emitting Diodes (LEDs)

Light-emitting diodes installed behind translucent lenses serve as the light source for many of the controls and displays in your vehicle. The concept behind their operation is related to that employed for lasers, and they are officially designated as Class 1 light-emitting diodes.



Do not remove the protective lens and avoid staring directly at the unfiltered beam for extended periods (several hours), as inflammation of the iris could result. ◀

OBD interface socket



Access to the interface socket for the On-Board-Diagnostics (OBD): Lift the cover (arrow) next to the steering column.

The purpose of the OBD (Onboard Diagnostic) system is to assure proper emission control system operation for the vehicle's lifetime by monitoring emission-related components and systems for deterioration and malfunction.



An illuminated indicator informs you of the need for service, not of the need to stop the vehicle.



However, the systems should be checked by your BMW center at the earliest possible opportunity.

Under certain conditions, the indicator will blink or flash. This indicates a rather severe level of engine misfire. When this occurs, you should reduce speed and consult the nearest BMW center as soon as possible. Severe engine misfire over only a short period of time can seriously damage emission control components, especially the catalytic converter.



When the filler cap is not properly tightened, the OBD system can detect the vapor leak and the indicator will light up. If the filler cap is subsequently tightened, the indicator should go out within a few days. ◀



**Replacement procedures:**

Onboard tool kit [144](#)
Windshield wiper blades [144](#)
Lamps and bulbs [145](#)
Repairing a flat tire [150](#)
Battery [153](#)
Fuses [156](#)

In case of electrical malfunction:

Fuel filler door [157](#)
Sliding/Tilt sunroof [157](#)

Assistance, giving and receiving:

Jump-starting [158](#)
Towing the vehicle [159](#)

Overview

Controls and features

Operation, care and maintenance

Owner service procedures

Advanced technology

Technical data

Index

144 Onboard tool kit



The onboard tool kit is located in the luggage compartment lid.

Loosen the wingnut to open.

Windshield wiper blades

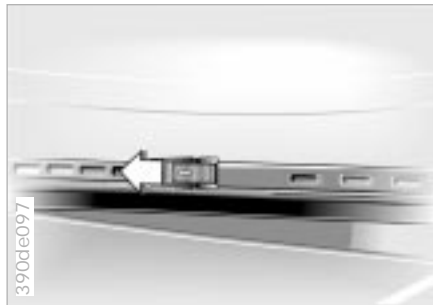

- 1 Lift the wiper arm up slightly and hold it firmly.
- 2 Press back the release (arrow) and pull the wiper blade back toward the base of the wiper arm.
- 3 Install the new blade and slide the release back into position.



Use only wiper blades approved by BMW. ◀

Lamps and bulbs

The lamps and bulbs are essential factors contributing to the safety of your vehicle. Observe the following instructions during bulb replacement carefully. If you are not familiar with any of the procedures, consult your BMW center.

 Do not touch the glass portion of a new bulb with your bare hands since even small amounts of impurities burn in to the surface and reduce the service life of the bulb. Use a clean cloth, paper napkin, or a similar material, or hold the bulb by its metallic base. ◀

A replacement bulb set is available from your BMW center.

 Whenever working on the electrical system, switch off the electrical accessory you are working on or disconnect the cable from the negative terminal of the battery. Failure to do this could result in short circuits. To prevent injuries and damage, comply with any instructions provided by the bulb manufacturer. ◀

Xenon lamps

The service life of these bulbs is very long and the probability of a failure is very low, provided that they are not switched on and off an unusual number of times. If one of these bulbs should nevertheless fail, it is possible to continue driving with great caution using the fog lamps, provided traffic laws in your area do not prohibit this.

 Because of the extremely high voltages involved, any work on the lighting system should be performed only by technicians with the appropriate qualifications. Failure to comply with this creates a risk of fatal injury. ◀

 When cleaning the headlamps, please observe the following:

- ▷ Do not clean by wiping with a dry cloth (this causes scratches). Never use abrasives or strong solvents to clean the covers.
- ▷ Remove dirt and contamination (such as insects) by soaking with BMW Car Shampoo and then rinsing with ample water.
- ▷ Always use a deicer spray to remove accumulated ice and snow – never use a scraper. ◀

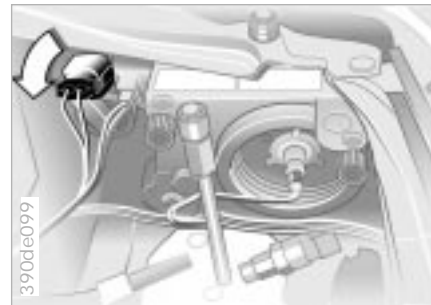

Parking lamp

5 watt bulb

- 1 Turn the bulb holder to the left (arrow) and remove.
- 2 Remove and replace the bulb.

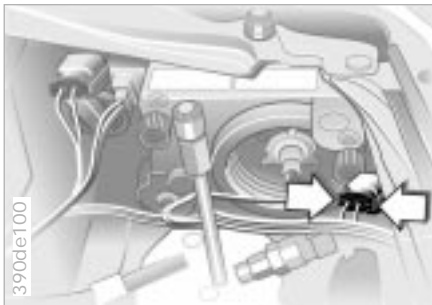

Turn signal indicator/Side lamps (side marker lamps), front

Dual-filament bulb, 21 watts

- 1 Press the tabs together (arrow) and remove the bulb holder.
- 2 Press gently on the bulb, turn it to the left and remove.
- 3 After replacing the bulb insert the holder (note lug positions) and snap it back into place.



Side turn signals*

5 watt bulb

- 1 Use finger pressure against the rear end of the lens (arrow) to press it forward for removal.
- 2 Apply gentle pressure to the bulb while turning it to the left to remove.



Front fog lamps

HB4, 51 watt bulb

 The bulb is pressurized. Therefore, wear safety glasses and protective gloves. Failure to comply with this precaution could lead to injury if the bulb is accidentally damaged during replacement. ◀

- 1 Pull the cover panel next to the fog lamp forward to remove.
- 2 Loosen the screw (arrow) and swing the lamp assembly out.
- 3 Release the spring on the back of the lamp and turn the cover to the left.
- 4 Release the clamp, remove the contact base and replace the bulb.

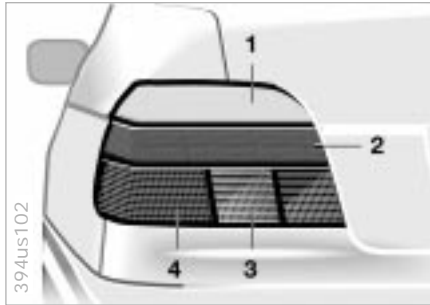

Tail lamp assembly

Tail lamps: 5 watt bulbs
 Remaining bulbs: 21 watts

- | | |
|--|-------|
| 1 Turn signal indicator | white |
| 2 Tail lamps/Side marker lamp, reflector | red |
| 3 Backup lamp | white |
| 4 Brake lamps | red |

 In the event of a failure of both lamps of a tail lamp assembly, the brake lamp assumes the function of the tail lamps. ◀

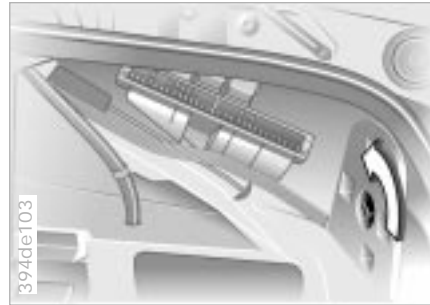

- 1 Use the upper handle to fold down the side panel in the luggage compartment.
- 2 Turn the bulb holder's release knob to the left (arrow) and remove the holder.
- 3 Apply gentle pressure to the bulb while turning it to the left to remove.

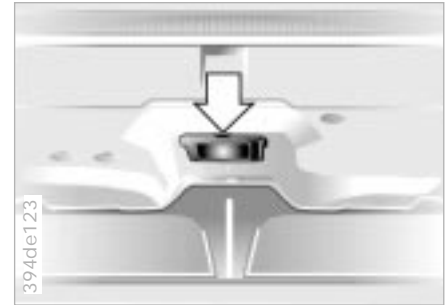

Center (high-mount) brake lamp*

21 watt bulb

- 1 Open the luggage compartment lid.
- 2 Unclip the cover panel (on the underside of the package tray) with a screwdriver (arrow).
- 3 Turn the bulb holder to the left and remove.
- 4 Apply gentle pressure to the bulb while turning it to the left to remove.



License plate lamps

5 watt bulb

- 1 Insert a screwdriver into the slot and press to the right (arrow); this disengages the lamp.
- 2 Remove the lamp and replace the bulb.

Interior lamps

Front

Interior lamp (10 watt bulb) with reading lamps (10 watt bulbs)

- 1 Interior lamp: Press the lamp out to the side with a screwdriver and remove the lens. Pull the bulb from the contact tabs.
- 2 Reading lamp: Gently press against the lamp while turning it to the left to remove it.

Indirect lighting

1 watt bulb

- 1 Unclip the lamp holder.
- 2 Remove the bulb.

Rear

Interior lamp (10 watt bulb) with reading lamp (5 watt bulb)

- 1 Use a screwdriver in the upper recesses to pry the lamp out.
- 2 Interior lamp: Push back the tab on the reflector and replace the bulb.
- 3 Reading lamp: Gently press against the lamp while turning it to the left to remove it.

Footwell lamps

5 watt bulb

- 1 Use a screwdriver to press the lens out to the side.
- 2 Replace the bulb.

Glove compartment lamp

5 watt bulb

- 1 Apply a screwdriver in the recess to pry the lamp out.
- 2 Remove the reflector.
- 3 Replace the bulb.

Luggage compartment lamps

Lamp on the underside of the rear package tray: 10 watt halogen lamp.

Lamp in luggage compartment lid: 10 watt bulb.

- 1 Apply a screwdriver in the recess to pry the lamp out.
- 2 Remove the reflector.
- 3 Replace the bulb.

Remote control



New transmitter

If you place a new transmitter into service (either a replacement or an additional transmitter), it must be initialized:

- 1 Enter the vehicle and close the doors.
- 2 Turn the ignition key briefly (max. 5 seconds) to position 1 in the steering lock and then turn it back to position 0. Remove the key.
- 3 Press button 1 (refer to the illustration) and hold it. Maintain pressure on button 1 while rapidly pressing button 2 three times in succession within a period of 10 seconds.

- 4 Release button 1.
- 5 The central locking system activates and releases all lock mechanisms in rapid succession to indicate that the initialization procedure has been successfully completed.

If the central locking system does not react, you must repeat the initialization procedure.

If you possess additional transmitters for your vehicle (up to a maximum of four units), you must now initialize these as well. Be sure that no more than 30 seconds is allowed to elapse between the individual initialization procedures. Repeat steps 3 and 4 for each of the transmitters when doing this. The central locking system will confirm every initialization procedure as described in step 5.

In the event of a system malfunction, please contact your BMW center. You can also obtain replacement transmitters here.

 Whenever you receive a new transmitter, turn that transmitter to position 2 in the ignition lock once (ignition switched on) and then back. This allows the electronic vehicle immobilizer (refer to page 31) to "learn" the new key.

To prevent unauthorized use of the transmitter, surrender only the door and ignition key 3 or the spare key (refer to page 30) when leaving the vehicle for valet parking, for instance. ◀

150 Repairing a flat tire



Precautions in case of a flat tire: Stop the vehicle as far as possible from passing traffic. Switch on the hazard warning flashers. Turn the steering wheel to the straight-ahead position, remove the key and engage the steering lock. Shift into 1st or reverse and engage the parking brake. All passengers should be outside the car and well away from your immediate working area (behind a guardrail, for instance).

If a warning triangle or portable hazard warning lamp is available, set it up on the roadside at an appropriate distance from the rear of the vehicle. Comply with all safety guidelines and regulations. ◀



M Mobility System

In the place of a spare tire, you will find the M Mobility System under the floor-mat of the luggage compartment in the M5.

- 1 Lift up the floormat and then raise the front cover panel.
- 2 Remove the fittings for attachment of the M Mobility System. Note the position of the fittings so that you can secure the system correctly following use.



Before you use the M Mobility System, read the warnings and danger notices on the device carefully. Always use the enclosed protective gloves and goggles. Failure to do so constitutes a personal safety hazard. ◀



Use of the M Mobility System is not effective if the damage to the tire is larger than approx. 3/16-inch (approx. 4 mm). Please consult the nearest authorized BMW center if you cannot repair the tire with the M Mobility System or contact BMW Roadside Assistance at 1-800-332-4269. ◀



Included in the system are:

- 1 Grip with button, cable and plug connector for the cigarette lighter socket to operate the compressor
- 2 Black connection hose from the compressor to the sealant container
- 3 Pressure gauge
- 4 Clear connection hose from the system to the wheel
- 5 Protective goggles
- 6 Protective gloves (not illustrated).



Procedure

 If possible, leave the foreign object in the tire. ◀

- 1 Remove the Maximum Speed Alert sticker from the top of the device and affix it to the steering wheel.
- 2 Remove the hoses and cable from the device.
- 3 Put on the protective gloves and goggles.
- 4 Connect the black hose 2 to the connector as shown in the illustration.



- 5 Remove the clear hose 4 from the plastic bag. Unscrew the valve cap from the valve stem of the wheel with the defective tire and screw the hose onto the valve stem.
- 6 Plug the free end of the hose onto the connector on the device as shown in the illustration.
- 7 Insert the plug connector 1 into the cigarette lighter socket in the vehicle's interior (refer to page 98).

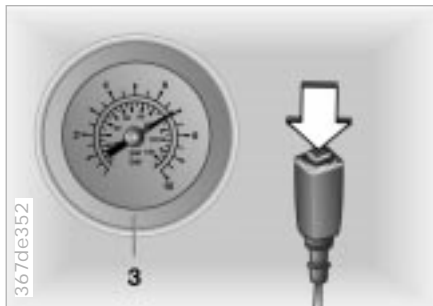

8 Press and hold the button for operating the compressor. Watch the pressure gauge carefully as you do so. As long as the pressure reading is between approx. 5–8 bar, sealant is being forced into the tire. When the pressure gauge falls significantly below approx. 5–8 bar while the compressor is operating, all of the sealant is in the tire. Air is being pumped into the tire.

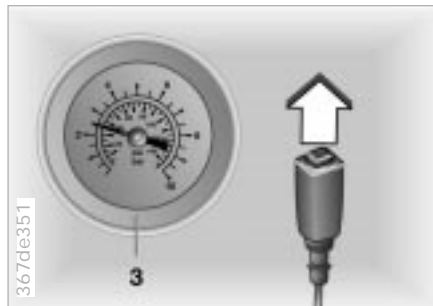

- 9 Continue to hold the button until there is a pressure reading of 2.5 bar. This may take several minutes.
- 10 To check the tire inflation pressure that has been reached, release the button.
- 11 After the tire has been filled with air, remove the black hose 2 from the device and disengage the clear hose 4 from the device. To do this, press the outer ring of the connector toward the device.
- 12 Now unscrew the hose 4 from the valve stem of the wheel. Screw the valve cap back onto the valve stem.
- 13 Return the hose to the plastic bag and store the M Mobility System in the luggage compartment.

 After using the M Mobility System, drive a distance of at least 1-1/4 miles (2 km) so that the sealant is distributed evenly within the tire. When doing so, do not drive below a speed of 12 mph (20 km/h) or above 36 mph (60 km/h). Following that, check the tire pressure as soon as possible – at the next filling station, for instance – and adjust the pressure to the correct specification (refer to page 26) if necessary. If the tire cannot hold the correct pressure, do not continue to drive. Consult the nearest authorized BMW center or a tire dealer. ◀

Replace the defective tire as soon as possible. Have the wheel and tire balanced and have the M Mobility System filled. Contact your authorized BMW center for this.

Please note that the system's sealant container must be replaced every three years by your BMW center if the device is not used.

You will find corresponding instructions for using the M Mobility System on the device.

Battery



Battery location

The battery is located under the floor-mat in the luggage compartment.

- 1 Read and comply with the warning information on page [154](#).
- 2 Lift the floor-mat.
- 3 Press the small cover gently. Lift the cover (arrow 1).
- 4 Disconnect the battery cable from the negative terminal.
- 5 Loosen the three screws (arrows) and remove the cover.

Symbols

You will find the following symbols on your car battery. To avoid injury, please comply with the corresponding precautions whenever you work with or near the battery.



Before handling the battery, please read the following information:



Wear eye protection. Do not allow particles containing battery acid or lead to come into contact with your eyes, your skin, or your clothing.



Battery acid is extremely corrosive. Wear eye protection and protective gloves. Do not tip the battery. Battery acid can leak from the ventilation openings.



Do not allow children access to batteries and battery acid.



Never allow sparks or open flame near the battery. Do not smoke in the vicinity of the battery. Avoid sparks from electrical cables or electrical equipment. Turn the key to position 0 in the steering lock when connecting or disconnecting the battery. Don't short-circuit the battery terminal. If you do so, you could be injured by electrical sparks.



A highly-explosive gas is generated when the battery is charged.



If you happen to get acid in your eyes, rinse thoroughly for 15 minutes with clear water. Consult a physician immediately. If your skin or clothing are splashed by acid, rinse immediately with plenty of water. If electrolyte is accidentally swallowed, consult a physician immediately.



In order to protect the battery case from ultraviolet radiation, do not place it in direct sunlight. A discharged battery can freeze. Store the battery in areas where temperature remains above freezing.

Battery care

The battery is absolutely maintenance-free, that is, the original electrolyte will normally last for the service life of the battery under moderate climatic conditions.



Charge condition

You can read the charge condition of the battery with the "Magic Eye*" (a hydrometer):

- ▷ Green: Adequate charge.
- ▷ Black: Not adequately charged. The battery has to be recharged. Please contact your BMW center for additional information.
- ▷ Yellow: Replace the battery.

▷ The service life specified for the battery can be achieved only if it is always kept adequately charged. Check the charge condition of the battery frequently if the vehicle is used primarily for driving short distances. ◀

Removal and installation

⚠ Do not disconnect the battery when the engine is running. If you do so, the ensuing voltage surge will damage the vehicle's onboard electronics.

Do not alter the positive terminal wiring in any way. If you do so, the Battery Safety Terminal's safety function will no longer be guaranteed. Repair and disposal must be performed by trained technicians only. ◀

When removing the battery, disconnect the cable on the negative terminal first, then the cable on the positive terminal.

When installing a battery, connect the positive terminal first, then connect the negative terminal.

⚠ When installing the battery, be sure that it is mounted securely in the battery well and that the cover is installed. If the battery is not mounted and fastened properly, it will not be adequately secured in case of an accident. ◀

Battery

Charging the battery

Charge the battery in the vehicle only when the engine is not running.

 Before doing any work on the electrical system, be sure to disconnect the cable from the battery's negative terminal. Failure to do so could result in short-circuits, a fire or personal injury. ◀

If the vehicle is to be parked longer than four weeks, disconnect the battery from the vehicle's electrical system by disconnecting the negative terminal cable and then recharge using a suitable charging device.

If you intend to store your car for longer than twelve weeks: Remove the battery, charge it and store it in a cool (but frost- and dust-free) room. Every three months and before reinstalling the battery, have it recharged. If it is not recharged, it will not be serviceable. Every time the battery is discharged, especially over extended periods, its service life is reduced.



Avoid environmental pollution when disposing of old batteries. ◀



Return used batteries to a recycling point or your authorized BMW center. Maintain the battery in an upright position for transport and storage. Secure the battery against tilting in transit. ◀

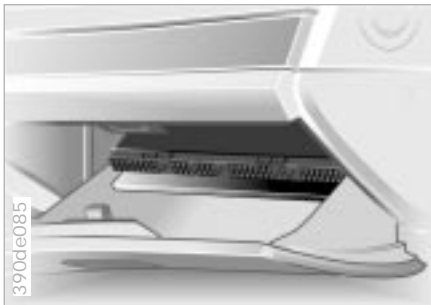

If an electrical accessory should fail, switch it off and check the fuse.

In the glove compartment

- 1 Open the glove compartment and turn the two white quick-release knobs to the left. Spare fuses and plastic tweezers are located on the fuse holder.
- 2 Use the plastic tweezers to remove the fuse for the accessory or equipment that has stopped working.
- 3 If the fuse is burned through (the metal strip will have melted and separated), replace it with a new fuse of the same ampere rating (color code).

The fuses, their respective ampere ratings and the equipment in their circuits are all indicated below the fuse holder.

Close the fuse holder by holding the top of the cover in place and screwing the two quick-release knobs to the right.

Additional fuses are provided in the luggage compartment (refer to the next column).

The fuse for continuous positive current is located in a separate fuse box above the battery. If this fuse is defective, refer the problem to your BMW center for repair.



Do not attempt to repair a burned fuse or replace it with a fuse having a different color or amperage rating. To do this could cause a fire in the vehicle resulting from a circuit overload. ◀

If the fuse continues to burn through, have the problem corrected by a BMW center.

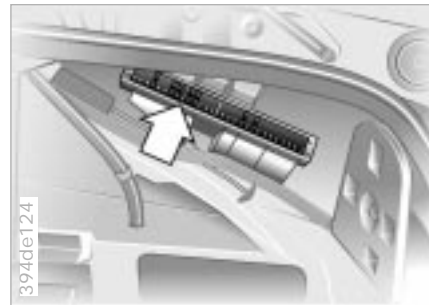

In the luggage compartment

Use the handle to pull the trim on the right wall down.

A list of the fuses, their respective ampere ratings and the equipment in their circuits is provided on the rear of the side trim.

Fuel filler door

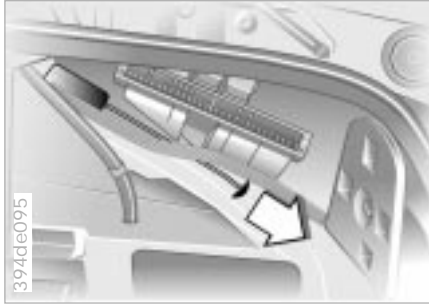

Manual release

- 1 Use the handle to lower the trim panel on the right side of the luggage compartment.
- 2 Pull the knob with the fuel pump symbol (arrow).

Sliding/Tilt sunroof*



Manual operation

- 1 Remove the interior lamp (refer to page 148), reach into the opening and push out the panel.
- 2 Use the Allen wrench from the on-board tool kit (refer to page 144) to turn the sliding/tilt sunroof in the desired direction.

Never use spray starter fluids.

If the battery is discharged, the engine can be started with the use of two jumper cables and the battery of another vehicle. Always use jumper cables with fully insulated handles on the terminal clamps.

 Do not touch the parts conducting electrical current while the car is running. To do so creates the risk of fatal injury. ◀

Carefully comply with the following instructions to avoid personal injury and damage to one or both vehicles:

- 1 Be sure that the battery on the support vehicle is also rated at 12 volts, and that the capacities of the two batteries (Ah) are roughly comparable (printed on casing).
- 2 Leave your battery connected to the car electrical system.
- 3 Make sure that there is no contact between the bodywork of the two vehicles – this creates a risk of short circuits.



- 4 Start by connecting the jumper cable from the positive terminal of the support vehicle to the positive terminal connector located in your BMW's engine compartment. The cover of the auxiliary terminal for jump starting is identified with a "Batt. +" sign. Refer to the illustration. Remove by lifting the cap.



- 5 Then connect the negative terminals. Attach the cable to either the support vehicle's negative battery terminal (-), or to a suitable ground on its engine or bodywork. Then connect the other end of the cable to a ground on the engine or on the bodywork of the vehicle that is to be started. There is a special nut on the strut dome of your BMW for this (refer to the arrow in the illustration).

 Observe the same sequence for connecting the jumper cables when helping other vehicles. If you do not, there is the risk of injury if sparks generate at the battery. ◀

Jump-starting

- 6 Start the engine of the support vehicle and let it run.
- 7 Start the engine on the vehicle needing the jump-start, and allow it to run as usual. If the first start attempt is not successful, wait a few minutes before another attempt in order to allow the discharged battery to recharge.
- 8 Before disconnecting the jumper cables from your BMW, turn on the headlamps, the rear window defroster, and set the blower to the highest speed; allow the engine to run approx. 10 seconds. This will prevent a voltage surge from the voltage regulator to the electrical accessories.
- 9 Then disconnect the jumper cables in reverse sequence.

Depending on the cause of the fault, recharge the battery.

Towing the vehicle



Tow fitting

The screw-in tow fitting is stored in the onboard tool kit; be sure that it remains in the vehicle at all times. This fitting is designed for installation in the tow sockets located at the front and rear of the vehicle, and is intended for towing on paved road surfaces only. It should not be used to pull a vehicle out of deep snow, mud, sand, etc. Always observe all applicable towing laws and regulations.

Access to tow sockets

Front:

Apply pressure to the arrow symbol on the cover; remove the cover.



Rear:

Apply pressure to the arrow symbol on the cover; remove the cover.

 Tightly screw in the towing fittings all the way. If you do not, the threads could be damaged. Never attach tie-down hooks, chains, straps, or tow hooks to tie rods, control arms, or any other part of the vehicle suspension, as severe damage to these components will occur, leading to possible accidents. ◀

Use only a nylon towing strap to tow the vehicle, since the inherent resilience of this material helps protect both vehicles from sudden jerking movements.

160 Towing the vehicle

 The towed vehicle should always be the lighter of the two vehicles. If this is not the case, it is no longer possible to control vehicle response. ◀

Tow-starting

It is better to start the vehicle's engine by jump starting. For instructions on jump starting, refer to page 158.

Never attempt to use your vehicle to push another car. This could cause damage to the energy-absorbing bumpers.

Towing a vehicle

- 1 Place the shift lever into "Neutral".
- 2 Leave the ignition key at position 1 to ensure that the brake lamps, turn signals, horn and windshield wipers remain operative, and to prevent the steering lock detent from engaging.
- 3 Switch on the hazard-warning system (comply with applicable regulations).

Find some means of identifying the vehicle in tow, for instance, place a sign or warning triangle in the rear window.

 Make sure that the ignition key remains in position 1 even when the electrical system has failed. This will prevent the steering lock from engaging. The steering and brakes are without power assist when the engine is not running. This means that increased effort is required for steering and braking. ◀

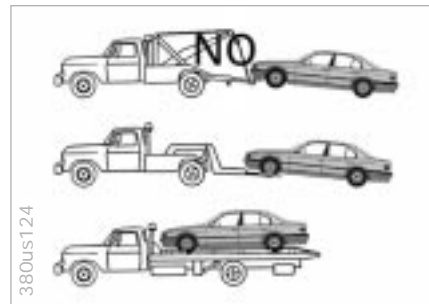

Towing with a commercial tow truck

- ▷ Do not tow with sling-type equipment.
- ▷ Use a wheel lift or flat bed carrier.
- ▷ Please comply with applicable towing laws.

 Never allow passengers to ride in a towed vehicle for any reason. ◀

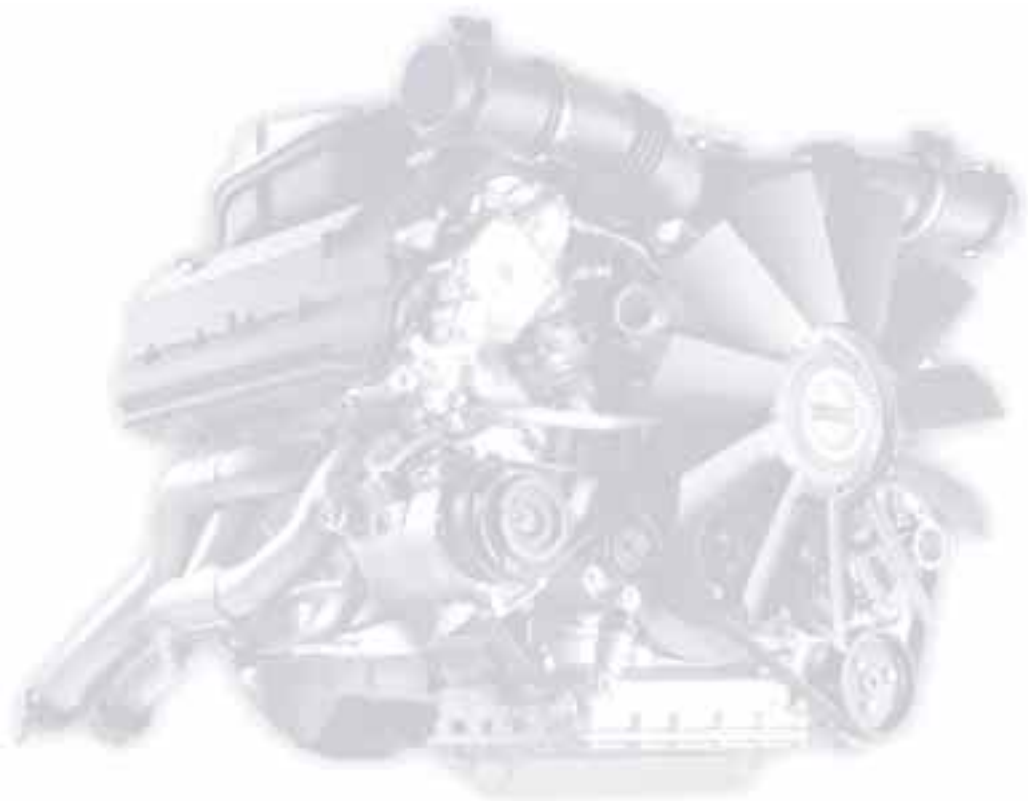



Airbags 164
Radio reception 164
BMW active seat 165
Dynamic Stability Control
(DSC) 166
Safety belt tensioner 166
DSP sound system 166
Interior rearview mirror with
automatic dimmer 167
Integrated rear suspension 167
Latent heat storage system 168
Rain sensor 168
Xenon lamps 169

Overview

Controls and features

Operation, care and maintenance

Owner service procedures

Advanced technology

Technical data

Index



Deceleration sensors continuously monitor the physical forces acting upon the vehicle. If, as the result of a frontal collision, a deceleration is reached at which the protection of the safety belts alone is no longer adequate, the gas generators of the driver and passenger-front airbags are ignited. However, the passenger-side airbag is only triggered if an additional sensor has recognized that the passenger seat is occupied.

In the event of a side collision, the head protection and side airbags in the front and rear* are triggered if necessary.

The airbags located under the marked covers inflate and unfold in a matter of a few milliseconds. In this process, they tear through the designed breaking points of the upholstered covers or press them out.

Because the inflation process must be virtually instantaneous, it is necessarily accompanied by a certain amount of ignition and inflation noise. The gas required to inflate the airbags is not dangerous, and the associated smoke then dissipates.

The entire process is completed within fractions of a second.

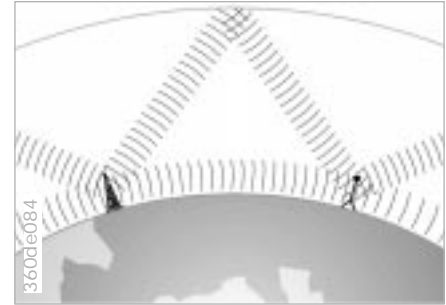

Radio waves – medium-wave, long-wave and short-wave – offer a wide range of reception, because the broadcast signals travel not only along the ground as surface waves, but also as waves bounced back to earth from the ionosphere.

Frequency-modulation (FM) provides substantially better sound quality than AM. However, because FM transmissions rely on line-of-sight broadcast waves, their effective reception range is limited.

Radio reception

Although numerous factors combine to impose inherent limitations on the reception quality available from mobile radios, specially designed systems can be employed to minimize their effects:

The "Radio Data System" (RDS) makes sure that, for broadcast stations sending on several frequencies, the radio automatically tunes to the frequency with the best reception quality.

The Diversity Antenna system employs several FM antennas integrated within the rear window. An integral processor automatically selects the antenna with the best FM reception quality at any given time. The selection of the antenna takes place within milliseconds, and is therefore not noticed by the radio listener.

BMW active seat*



BMW seats are configured for your orthopedic well-being. The active seat is an engineering enhancement of BMW's seats, designed to ensure less fatigue during extended trips while sitting with little movement. The seat is no longer a passive element between the road, the running gear and the passenger. Instead, it creates minor and imperceptible shifts in your weight by an active change in the contour of the seat surface. The basic seat position is not changed as this occurs.

Fluid cushions are located below the surface of the seat in the seat's upholstery on the left and right. The fluid is circulated slowly back and forth between the two cushions by means of a pump. This causes a movement of the spinal column which is virtually imper-

ceptible, resulting in an improved flow of blood to the vertebral discs and the muscles in the area of the spinal column. Vehicle occupants can experience less muscle cramping, back pain in the spine's lumbar region and fatigue. The active seat thus provides a significant contribution to your driving comfort and safety.

Precision sensors monitor the number of revolutions of the wheels, the steering angle, lateral acceleration, brake pressure and the movement of the vehicle around its vertical axis.

If differences in the wheel speeds occur, the system counteracts the danger of wheelspin by reducing engine torque. If necessary, the system also responds with additional application of the brakes at the rear wheels.

If the system detects an instability in the vehicle's condition, the braking action can also be directed to the front wheels in order to help stabilize the vehicle.

You may need some time to become accustomed to this system intervention. However, it provides optimum drive force and vehicle stability.

The braking intervention is accompanied by sounds specific to the system.

Safety belt tensioner



The safety belt tensioner responds to severe frontal collisions by tightening the belts to ensure that occupants remain firmly positioned in their seats. A gas-pressure system retracts the buckle assembly to tension the shoulder and lap belts within fractions of a second. This reduces the tendency to slide under the lap belt.

DSP sound system*

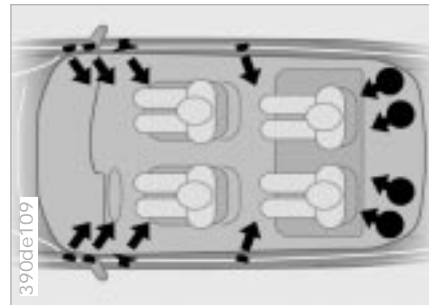

The DSP Professional premium sound system features a special amplifier combined with Digital Sound Processing (DSP) and integrated speakers to surround you with crisp, true-to-life sound reproduction. The speaker system's subwoofers, woofers, midrange speakers and tweeters furnish you with an impressively full-bodied listening experience. The loudspeakers are oriented in such a manner that they produce the aural sensation that you would experience facing the stage in a concert hall. The system also automatically adjusts the bass and treble settings to compensate for changes in volume and vehicle speed.

Rearview mirror with automatic dimmer

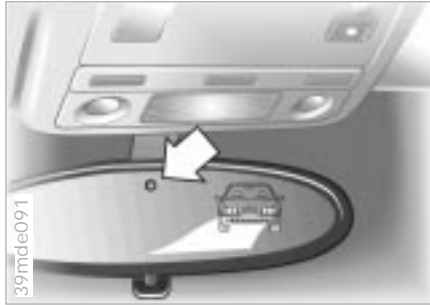

The semisolid reacts chemically to this electrical current, thus providing dimming of the mirror through an infinitely-variable range (electrochromic technology).

As a result, it is no longer necessary to dim the mirror manually, and the driver can concentrate completely on traffic conditions.

The interior rearview mirror with automatic dimming feature reduces glare from following traffic by adapting the intensity of the reflected images to correspond to levels of light registered by the unit's sensors. The mirror reverts to its undimmed setting as soon as the light source is removed. One lamp sensor is mounted on the front of the mirror housing. This sensor is directed forward. It measures light intensity in the area ahead of the vehicle. The second sensor is integrated within the mirror's glass. The electronic control system compares the light intensity from front and rear. The difference provides the basic parameter used to modulate an electrical current and induce chemical changes in a semisolid layer incorporated in the lens.

Integrated rear suspension¹⁶⁷

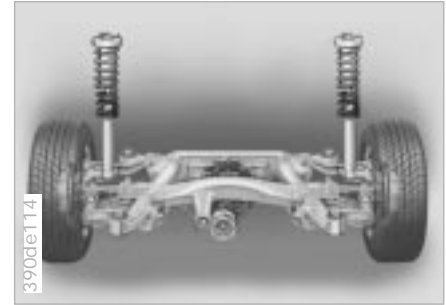

The control arms on the patented integrated aluminum rear axle assembly are not mounted directly on the body. They are mounted elastically on a chassis sub-frame which is joined in turn with elasticity to the vehicle body. The resulting double elastic suspension system effectively absorbs the forces resulting from bumps and road surface irregularities.

The compliance rates of the integrated rear axle assembly's control arm mounts have been precisely calibrated to help provide supplementary adjustment in the tracking angle of the rear wheels (programmed self-steer effect). The ultimate result is enhanced safety and control under all conditions.

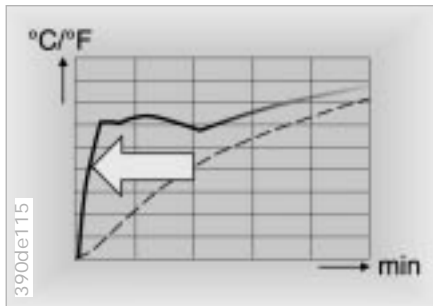

The latent heat storage system accumulates and stores engine heat – even for several days at extremely low outside temperatures. After the engine is started, this accumulated heat can be utilized immediately to defrost the windshield and side windows and to remove condensation from them. In addition, the time required for warming the interior of the vehicle and for warming up the engine (arrow) are significantly reduced.

The latent heat storage system consists of an accumulator reservoir that is extremely well insulated. It is connected with the engine's cooling system.

The principle is based on the utilization of latent heat that is released during the conversion of an environmentally-compatible salt mixture from a liquid to a solid state. In a process analogous to the latent heat fusion of ice, the heat produced by the warm engine is stored by the liquefaction of the salt mixture.

An "empty" latent heat storage system is ready for operation again after approx. 15 minutes of driving.

The latent heat storage system thus enhances driving safety and comfort without producing environmental pollutants.

Active operation is not required since the system is electronically controlled.

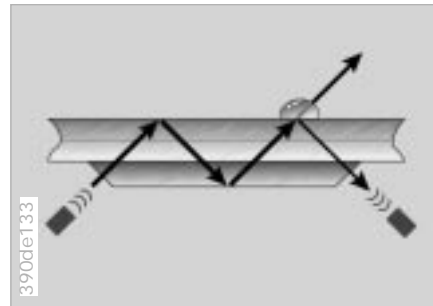

The rain sensor controls windshield wiper operation, depending on how wet the windshield is.

Infrared light is carried along the surface of the windshield in an optical conductor in such a manner that it is reflected completely when the windshield is dry. The quantity of reflected light is measured.

If there is moisture on the glass, the amount of light reflected is reduced since the infrared light at the surface of the windshield can escape. The quantity of reflected light is thus a means of gauging the degree of wetness on the windshield.

When the "Intermittent" wiper speed position is selected, the wiper reacts immediately if water is splashed onto the windshield from vehicles traveling ahead, for example. As a result, the rain sensor provides a contribution to driving safety and comfort.

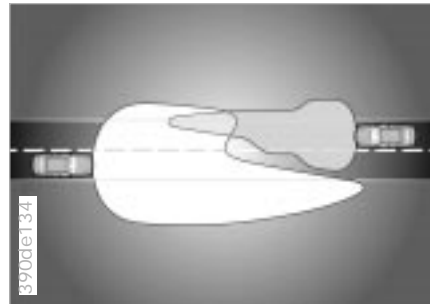

Xenon lamps illuminate the side and front areas of the vehicle with significantly more brightness and uniformity than traditional halogen lamps.

In a xenon lamp, an electric arc replaces the filament in order to generate intense illumination. A gas mixture in a quartz glass tube with metal vapor is ignited by a high electric voltage. The arc that is generated is then sustained by a lower voltage. When the lamp is turned on there is a brief warm-up period. Maximum brightness is attained in approx. 15 seconds.

Xenon lamps improve the driver's visibility and orientation to the road, especially in adverse weather conditions and driving situations (driving at night in heavy rain or through road repair areas where there are no lane markers, for instance).

Vehicles with xenon lamps are equipped with automatic headlamp range control. As a result, the highway is always optimally lighted, regardless of load conditions, and drivers in oncoming traffic are not blinded.

Xenon lamps make a significant contribution to highway safety since other highway users, or bicyclists and motorcyclists in the right lane, and pedestrians are more easily detected.

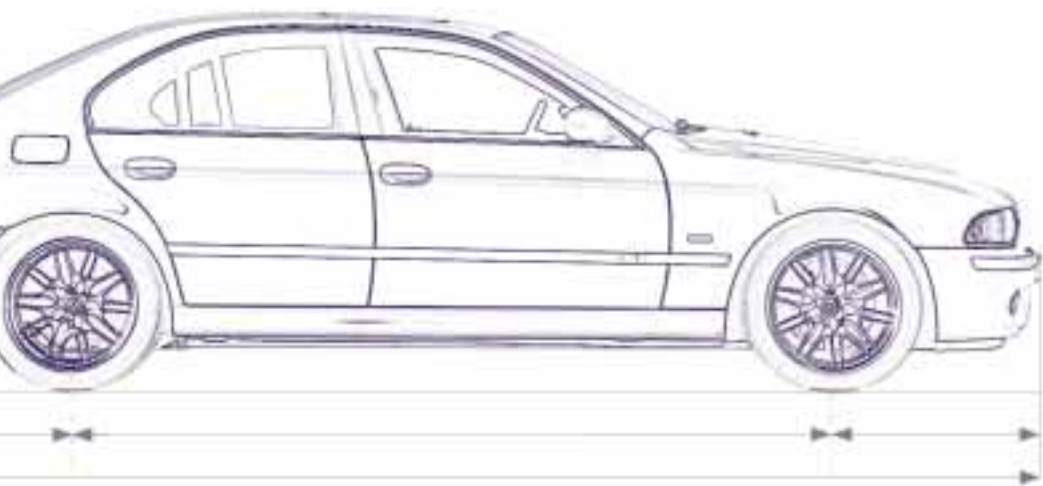

Engine data [172](#)
Dimensions [173](#)
Weights [174](#)
Capacities [175](#)
Electrical system [176](#)
Drive belts [176](#)

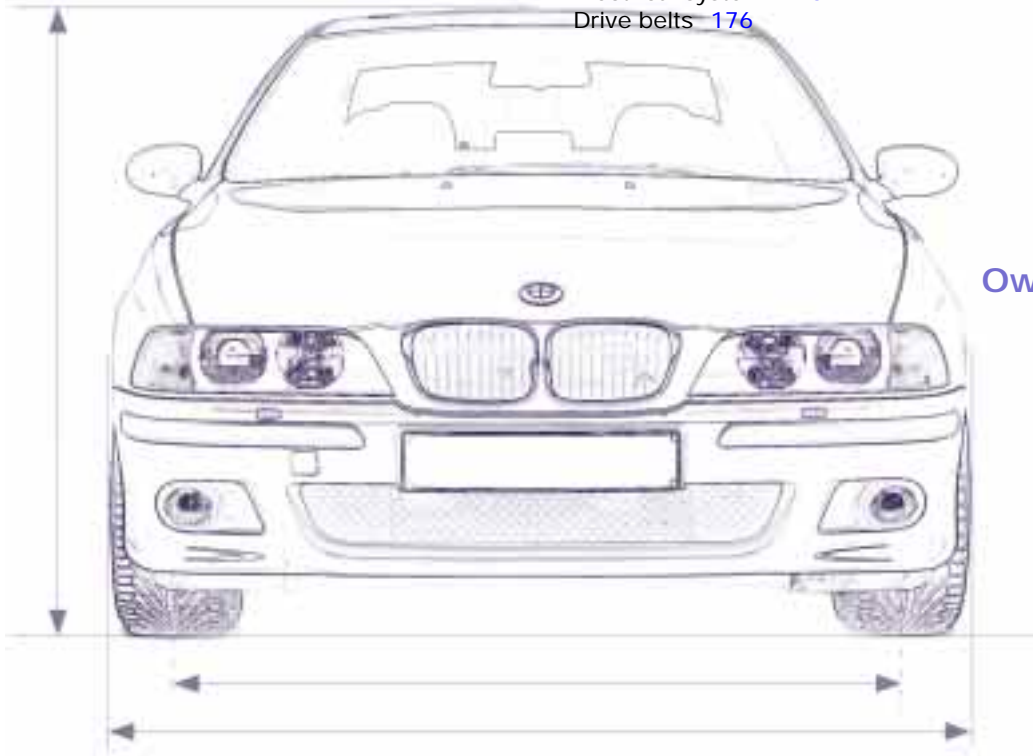

[Overview](#)

[Controls and features](#)

[Operation, care
and maintenance](#)

[Owner service procedures](#)

[Advanced technology](#)

[Technical data](#)

[Index](#)

Overview

Controls

Car care

Repairs

Technology

Data

Index

172 Engine data

		BMW M5
Displacement	cu in (cm ³)	301.5 (4,941)
Number of cylinders		8
Max. output at engine speed	hp RPM	394 6,600
Maximum torque at engine speed	lb ft (Nm) RPM	368 (500) 3,800
Compression ratio	ε	11.0
Stroke	in (mm)	3.50 (89.0)
Bore	in (mm)	3.70 (94.0)
Fuel-injection system		Digital-electronic engine-management system

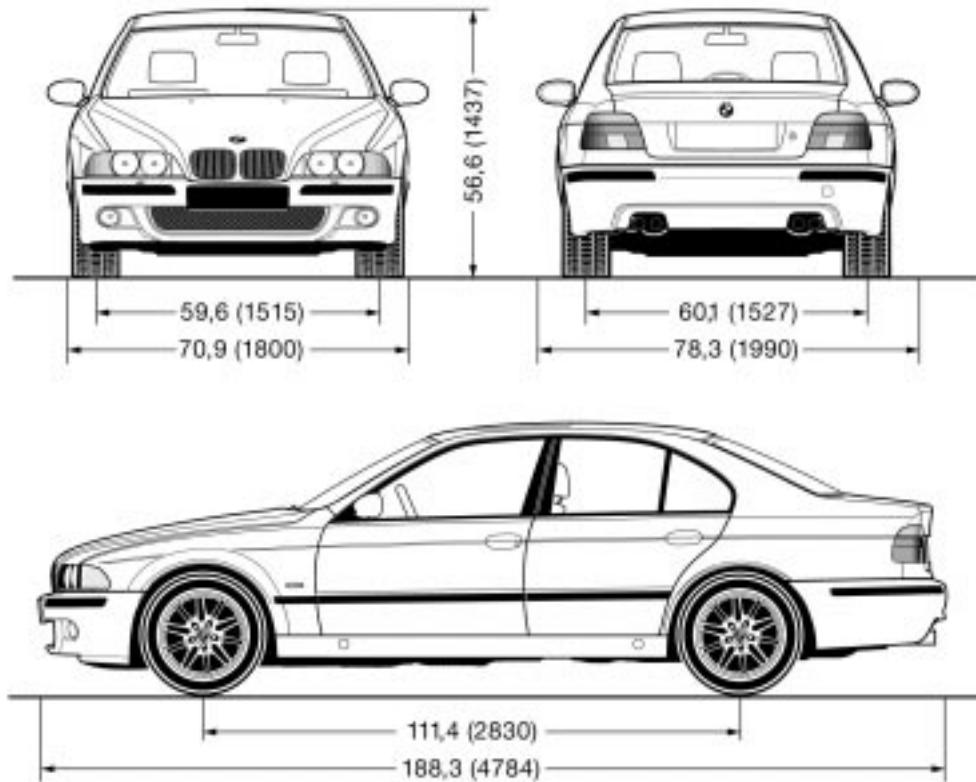

All dimensions are given in inches (mm). Minimum turning circle dia.: 38.1 ft (11.6 m)

174 **Weights**

BMW M5		
Curb weight (with one person, ready for operation, full tank of fuel, options not included)	lbs. (kg)	4,024 (1,825)
Approved gross vehicle weight	lbs. (kg)	5,049 (2,290)
Approved front axle weight	lbs. (kg)	2,426 (1,100)
Approved rear axle weight	lbs. (kg)	2,701 (1,225)
Approved roof load capacity	lbs. (kg)	220 (100)
Never exceed either the approved axle weights or the gross vehicle weight.		
Luggage compartment capacity	cu ft (liters)	16.2 (460)

		Notes
Fuel tank reserve	gal. (liters) approx. 18.5 (approx. 70) gal. (liters) approx. 2.6 (approx. 10)	Fuel specification: page 26
Windshield washer system, with headlamp washer system	quarts (liters) approx. 3.7 (approx. 3.5)	For details: page 126
Intensive cleaning system	quarts (liters) approx. 6.3 (approx. 6.0) quarts (liters) approx. 1.1 (approx. 1.0)	
Cooling system including heater circuit	quarts (liters) 12.7 (12.0)	For details: page 129
Engine oil and filter change	quarts (liters) 6.9 (6.5)	BMW High Performance Synthetic Oil: Refer to page 128
Manual transmission	-	Fluid change at the 1.200 Mile Service, then lifetime fluid; no fluid change required
Differential	-	Fluid change at the 1.200 Mile Service, then lifetime fluid; no fluid change required

176 Electrical system

Battery

12 V, 110 Ah

Spark plugs

NGK BKR 6 EQUIP

Bosch FGR 7 DQP (not released at this time)

This spark ignition system meets all requirements of the Canadian Interference-Causing Equipment Regulations (ICES-2).

Drive belts

Water pump – AC generator – power steering

Ribbed V-belt 7K x 1629

A/C compressor

Ribbed V-belt 5 K x 980



You can obtain Original BMW Parts and Accessories, as well as professional advice from your BMW center. ◀

A B C

P Q R



Everything from A to Z 180
Owner service procedures 186

Overview

Controls and features

Operation, care
and maintenance

Owner service procedures

Advanced technology

Technical data

Index

Overview

Controls

Car care

Repairs

Technology

Data

Index

Everything from A to Z

A

ABS (Antilock Brake System) 21, 109
Accessories 6
Activated charcoal filter 87
Active seat 48, 165
Adding engine oil 127
Adding washer fluid 126
Adjusting seats 45
Adjusting the backrest 45
Adjusting the steering wheel 48
Air distribution 84
Air outlets 82
Air pressure 116
Air supply 85
Airbags 21, 54, 139, 164
Alarm system 40
Antenna, Diversity 165
Antennas 115
Antifreeze 129
Antifreeze, radiator 113
Antilock Brake System (ABS) 21, 109
Anti-theft alarm system 40
Aquaplaning 107, 116
Ashtray 97
Attaching a car vacuum cleaner 98
AUC (Automatic recirculated air control) 85
Automatic car washes 133

Automatic climate control 82
removing condensation from windows 85
Automatic cruise control 67
Automatic curb monitor 51
Automatic dimming, interior rearview mirror 49, 167
Automatic recirculated air control (AUC) 85
Automatic windshield washer 66
Avoiding unintentional alarms 41
Axle loads 174

B

Backup lamps 64
bulb replacement 147
Battery 153, 176
capacity 176
charge 155
charge condition 154
discharged 158
removal and installation 154
Battery Safety Terminal (BST) 154
Belts 53
Beverage holder 96
Blower 85
BMW active seat 48, 165

BMW comfort seat 47
BMW High Performance Synthetic Oils 128
BMW M Sports Seat 45
BMW Universal Transmitter 91
Brake fluid 130
Brake hydraulic system, brake pads 20
Brake lamps, bulb replacement 147
Brakes 111
malfunctions 112
Break-in procedure 106
Breaking in the vehicle 106
Break-resistant security glass, care 136
BST (Battery Safety Terminal) 154
Bulb replacement 145

C

Car battery 176
Car keys 30
Car Memory 52
Car radio
refer to the Onboard Computer Owner's Manual
Car radio reception 115, 164
Car wash 133
Care, exterior 134
Care, vehicle interior 137
Cargo loading 102
Caring for the vehicle finish 135
Catalytic converter 108
starting problems 108
Cellular phones 96, 115
Cellular telephone
refer to the separate Owner's Manual
Center (high-mount) brake lamp 147
Central locking system 32
key 36
Charge condition, battery 154
CHECK button 72
Check Control 72
Check engine oil level 127
Check oil level 127
Cigarette lighter 98
Clock
refer to the Onboard Computer Owner's Manual
Cockpit 16
Comfort seat 47
Compartments 96
Configure settings 52
Contamination on paintwork 134
Control elements 16
Coolant 113, 129

Coolant temperature gauge 71

Coolant, antifreeze 113

Cover, sun blinds 90

Cruise control 67

Cup holder 96

Curb weight 174

D

Dashboard 16

Date

refer to the Onboard Computer Owner's Manual

Daytime-driving light switch 79

DBC (Dynamic Brake Control) 21, 112

Deactivating the interior motion sensor 41

Deactivating the tilt sensor alarm system 41

Deep water 107

Defrost position 85

Defrosting the windows 85

Digital clock

refer to the Onboard Computer Owner's Manual

Digital sound processor 166

Dimensions 173

Dipstick, engine oil 127

Disc brakes 111

Displacement 172

Display lighting 79

Displays 18

Distance warning 75

Divided rear backrest 99

Door keys 30

Door locks, care 113

Doors

emergency operation 32

manual operation 32

remote control 33

unlocking and locking 32

Drive belts 176

Driving notes 107

DSC (Dynamic Stability Control) 21, 76, 166

DSP amplifier

refer to the Onboard Computer Owner's Manual

Dynamic Brake Control (DBC) 21, 112

Dynamic Stability Control (DSC) 21, 76, 166

E

Electric power windows 42

safety switch 43

Electrical malfunction

fuel filler door 157

sliding/tilt sunroof 157

Electronic vehicle

immobilizer 31

Emergency operation

doors 32

fuel filler door 157

luggage compartment

lid 37

sliding/tilt sunroof 157

Engine compartment 124

Engine coolant 129

Engine data 172

Engine oil consumption 127

Engine oil grades 128

Engine oil level 20

Engine oil pressure 20

Engine oil temperature gauge 70

Engine performance 172

Engine starts 62

Exterior finish 134

Exterior mirrors 49

F

Failure messages 72

Failure of an electrical accessory 156

Fault displays 72

Filler cap cover 25

Filling capacities 175

First aid 24

First-aid kit 24

Flashlight 95

Flat tire 116

Fog lamps 80

bulb replacement 146

Folding rear backrest 99

Footbrake 111

Footwell lamps 80

bulb replacement 148

For included equipment, refer to the Service and Warranty Information Booklet

Front seat adjustment 45

Frost protection, radiator 129

Fuel filler door releasing following an electrical malfunction 157

Fuel gauge 70

Fuel tank capacity 175

Fuses 156

G

Gasoline gauge 70

Glove compartment 95

Glove compartment lamp, bulb replacement 148

Grills 82

Gross vehicle weight 174

H

Handbrake 21, 63

Handsfree system 96

Everything from A to Z

Hazard warning flashers [24](#)
Hazard warning triangle [24](#)
Head restraints [46](#)
Headlamp cover, care [133](#)
Headlamp flasher [64](#)
Headlamp washer
 system [126](#)
Headlamp washers [66](#)
Heat storage [168](#)
Heated seats [90](#)
Heater and ventilation [82](#)
Heating while stopped [86](#)
Heavy cargo [102](#)
Height [173](#)
Height adjustment
 seats [45](#)
 steering wheel [48](#)
HiFi system [166](#)
High beams [22, 80](#)
Hood release [123](#)
Horn [17](#)
Hydraulic Brake Assistant
 refer to DBC [21, 112](#)

I
Ice warning [69](#)
Identification, tires [119](#)
Ignition key [30](#)
Ignition lock [61](#)
Independent ventilation [90](#)
Indicator lamps [20](#)
Inflation pressure [116](#)

Inflation pressure
 monitoring [77](#)
INSPECTION [71](#)
Instrument cluster [18](#)
Instrument lighting [79](#)
Instrument panel [18](#)
Integrated rear axle [167](#)
Integrated rear center
 console [88](#)
Integrated rear-seat
 equipment [94](#)
Intensive automatic cleaning
 unit [66](#)
Intensive cleaning
 system [126](#)
Interaxle tire rotation [118](#)
Interface socket for On-
 Board-Diagnostics [141](#)
Interference with car
 phones [115](#)
Interior lamps [34, 80](#)
 bulb replacement [148](#)
 remote control [34](#)
Interior rearview mirror,
 automatic dimming
 feature [49, 167](#)
Intermittent switch [65](#)

J
Jets [82](#)
Jump-starting [158](#)

K
Key Memory [52](#)
Keys [30](#)
Keys with remote control [30](#)

L
Lashing eyes [39, 102](#)
Latent heat storage
 system [168](#)
Leather care [138](#)
Length [173](#)
License plate lamp, bulb
 replacement [148](#)
Light switch [79](#)
Light-alloy wheels [122](#)
Lighter [98](#)
Lights-on warning [79](#)
Load-securing devices [102](#)
Low beams [79](#)
Low-fuel warning lamp [70](#)
Luggage compartment [37](#)
 capacity [174](#)
 emergency operation [37](#)
 opening from the
 inside [38](#)
 remote control [35](#)
 securing separately [37](#)
Luggage compartment
 lid [37](#)
 manual operation [37](#)
 opening from the
 inside [38](#)

 opening separately [37](#)
 securing separately [37](#)
Luggage compartment
 lighting [37](#)
Luggage net [39](#)
Luggage straps [39](#)
Lumbar support [46](#)

M
M Dynamic Driving
 Control [77](#)
M Mobility System [150](#)
M+S tires [120](#)
Magic Eye
 refer to Battery charge
 condition [154](#)
Maintenance [71, 132](#)
Manual operation
 doors [32](#)
 fuel filler door [157](#)
 luggage compartment
 lid [37](#)
 sliding/tilt sunroof [157](#)
Manual transmission [64](#)
Memory [50](#)
MFL (Multifunction steering
 wheel) [23](#)
Microfilter [87](#)
Mirror defrosting [49](#)
Mirror memory [50](#)
Mirrors [49](#)
Mobile phones [115](#)

Mobile telephone
 refer to the separate
 Owner's Manual
 Modifications,
 technical 6, 140
 Multifunction steering wheel
 (MFL) 23
 Multifunction switch 64

N

Navigation system
 refer to the separate
 Owner's Manual
 New transmitter, remote
 control 149

O

OBD interface socket 141
 Odometer 69
 Oil additives 127
 Oil change interval, see the
 Service and Warranty
 Information Booklet
 Oil consumption 127
 Oil dipstick 127
 Oil grades 128
 Oil pressure, indicator
 lamp 20
 OILSERVICE 71
 Onboard computer 74
 refer also to the Onboard
 Computer Owner's Manual

Onboard tool kit 144
 Opening and closing
 from inside 36
 from outside 32
 Operating the independent
 ventilation system
 refer to the Onboard
 Computer Owner's Manual
 Outlets, ventilation 82
 Outside temperature
 display 69

P

Paintwork, minor
 repairs 135
 Paintwork, waxing 135
 Park Distance Control
 (PDC) 75
 Parking aid 75
 Parking brake 21, 63
 Parking lamps 80
 bulb replacement 145
 Parking, winter 114
 Passenger side mirror tilt
 function 51
 PDC (Park Distance
 Control) 75
 Performance
 Recognition 77
 Playing CDs, playing
 cassettes
 refer to the separate
 Owner's Manual

Pocket flashlight 95
 Pollen 87
 Power seat 45
 Power steering 115
 Power windows 42
 Pressure monitoring,
 tires 77
 Pressure, tires 116

R

Radio
 refer to the Onboard
 Computer Owner's Manual
 Radio Data System
 (RDS) 165
 Radio reception 115, 164
 Radios 115
 Rain sensor 65, 168
 RDS (Radio Data
 System) 165
 RDW (Tire Pressure
 Warning) 77
 Reading lamps 81
 Rear backrest, folding 99
 Rear window
 defroster 67, 86
 Rear-seat backrest,
 folding 99
 Rearview mirrors 49
 Recirculated air mode 85
 Reclining seat 45
 Refueling 25

Remote control 33
 new transmitter 149
 Removing condensation
 from windows 85
 Repairing a flat tire 150
 Replacement keys 30, 149
 Replacement of tires 118
 Replacing windshield wiper
 blades 144
 Replacing wiper blades 144
 Reporting safety defects 7
 Reservoir, washer
 system 126
 Residual heat 86
 Reverse 64
 Rims 119
 Roller sun blinds 90
 Roof load capacity 174
 Roof-mounted luggage
 rack 103
 Rubber parts 113

S

Safety belt
 tensioners 55, 166
 Safety belts 53, 55
 Safety buttons 36
 Seat heating 90
 Seat memory 50
 Securing cargo 39, 102
 Securing the load 102
 Service and Warranty
 Information Booklet 132

Everything from A to Z

- Service Interval
 - Display 71, 132
- Shutting off the engine 62
- Side airbags 54
- Side impact Head Protection System 54
- Side lamps 79
 - bulb replacement 146
- Ski bag 100
- Skid control 114
- Sliding/Tilt sunroof 43
 - closing after an electrical malfunction 157
 - convenience operation 32
 - remote control 33
- Slippery roads 113
- Snow chains 113, 121, 122
- Socket 98
- Spare key 30, 149
- Spark plugs 176
- Speaker 96
- Special oils 128
- Speedometer 18
- Sports Seat 45
- Starting 62
- Starting assistance 158
- Starting problems 158
- Starting the engine 62
- Steering 115
- Steering wheel lock 61
- Steering wheel memory 50
- Stopwatch
 - refer to the Onboard Computer Owner's Manual
- Storage compartments 96
- Summer tires 119
- Sun visors 50
- Symbols 4, 153
- T**
- Tachometer 70
- Tail lamp 147
- Tail lamp assembly, bulb replacement 147
- Tank capacity 175
- Technical modifications 6, 140
- Telephone
 - refer to the separate Owner's Manual
- Telephone hookup 96
- Temperature adjustment 84
- Temperature display
 - engine oil 70
 - outside temperature 69
- Temperature gauge
 - engine coolant 71
- Temperature layering 86
- Thigh support adjustment 46
- Third brake lamp 147
- Through-loading system 99
- Tilt alarm 34
- Tilt function, passenger side mirror 51
- Timer
 - refer to the Onboard Computer Owner's Manual
- Tire code 119
- Tire damage 116
- Tire inflation pressure 116
- Tire pressure monitoring 77
- Tire Pressure Warning (RDW) 77
- Tire replacement 118
- Tire specifications 122
- Tire tread 116
- Tools 144
- Torque 172
- Tow starting 160
- Towing 159
- Towing fittings 159
- Track width 173
- Traction Control System
 - refer to DSC 76
- Transmission 64
- Tread depth, tires 116
- Trip odometer 69
- Trunk 37
 - capacity 174
- Trunk lamps
 - bulb replacement 148
- Trunk lid, refer to luggage compartment lid 37
- Turn signal indicator 22, 64
 - bulb replacement 146
- Turning circle 173
- U**
- Uniform Tire Quality Grading (UTQR) 117
- Universal Transmitter 91
- Used batteries 155
- V**
- Vanity mirror 50
- Vehicle battery 153
- Vehicle care,
 - interior 136, 137
- Vehicle identification 131
- Vehicle Identification Number (VIN) 131
- Vehicle immobilizer 31
- Vehicle storage 139
- Ventilation 82, 86
- Ventilation in the rear 87
- Ventilation while parked 90
- Ventilation while parked, operation
 - refer to the Onboard Computer Owner's Manual
- Ventilation, draft-free 86
- Vinyl care 137

W

- Warm feet – cool head [86](#)
- Warning lamps [20](#)
- Warning messages [72](#)
- Washer reservoir, filling [126](#)
- Washer/Wiper system [65](#)
- Washing your car [133](#)
- Water on the roads [107](#)
- Waxing, paintwork [135](#)
- Weights [174](#)
- Wheelbase [173](#)
- Wheels and tires [119](#), [122](#)
- Width [173](#)
- Windows [42](#)
 - convenience operation [32](#)
 - remote control [34](#)
- Windshield washer nozzle adjustment [126](#)
- Windshield washer reservoir, filling [126](#)
- Windshield wiper [65](#)
- Winter operation [113](#)
- Winter tires [119](#), [120](#)
- Wipers [65](#)
- Work in the engine compartment [123](#)

X

- Xenon lamps [145](#), [169](#)

Owner service procedures

A

Adding brake fluid [130](#)
Adding coolant [130](#)
Adding engine coolant [130](#)
Adding engine oil [127](#)
Adding washer fluid [126](#)
Avoiding false alarms [41](#)
Avoiding unintentional alarms [41](#)

B

Backup lamps, bulb replacement [147](#)
Battery charge condition [154](#)
Brake lamps, bulb replacement [147](#)
Brakes, brake faults [112](#)
Break-resistant safety glass, care [136](#)

C

Catalytic converter, starting problems [108](#)
Charge condition, battery [154](#)
Charging the battery [155](#)
Check air pressure [26](#)
Check Control [72](#)
Check engine oil level [127](#)
Check oil level [127](#)

D

Deactivating the interior motion sensor [41](#)
Deactivating the radio-controlled interior motion sensor [41](#)
Deactivating the tilt sensor alarm system [41](#)
Defrosting the windows [85](#)
Difficult steering [115](#)
Doors, manual operation [32](#)

E

Electrical malfunction
fuel filler door [157](#)
sliding/tilt sunroof [157](#)
Emergency operation
doors [32](#)
fuel filler door [157](#)
luggage compartment lid [37](#)
sliding/tilt sunroof [157](#)
Engine oil grades [128](#)

F

Failure messages [72](#)
Failure of an electrical accessory [156](#)
Fault displays [72](#)
First aid [24](#)
First-aid kit [24](#)
Fittings, tow starting and towing [159](#)

Fog lamp, replace the bulb [146](#)
Footwell lamps, bulb replacement [148](#)
Fuse replacement [156](#)

G

Glove compartment lamp, bulb replacement [148](#)

H

Hazard warning flashers [24](#)
Hazard warning triangle [24](#)
Hood release [123](#)

I

Indicator lamps [20](#)
Inflated pressure [26](#)
Inflation pressure [26](#)
Interior lamps, bulb replacement [148](#)

L

License plate lamps, bulb replacement [148](#)
Luggage compartment lamps, bulb replacement [148](#)
Luggage compartment lid, emergency operation [37](#)

M

Mobility System [150](#)
Maintenance [71](#), [132](#)
Malfunction displays [72](#)
Manual operation
doors [32](#)
fuel filler door [157](#)
luggage compartment lid [37](#)
sliding/tilt sunroof [157](#)

N

New transmitter, remote control [149](#)

O

Oil grades [128](#)
Onboard tool kit [144](#)

P

Parking lamps
bulb replacement [145](#)
Pressure, tires [26](#)

R

Releasing the fuel filler door after an electrical malfunction [157](#)
Remote control
new transmitter [149](#)
Removing condensation from windows [85](#)

Repairing a flat tire [150](#)

Replacement key [30](#), [149](#)

Replacing bulbs [145](#)

Replacing windshield wiper blades [144](#)

Replacing wiper blades [144](#)

Reservoir, washer system [126](#)

S

Side lamps, bulb replacement [146](#)

Sliding/Tilt sunroof closing after an electrical malfunction [157](#)
power loss [44](#)

Snow chains [121](#)

Spare key [30](#), [149](#)

T

Tail lamp assembly, bulb replacement [147](#)

Tail lamps, bulb replacement [147](#)

Tire damage [116](#)

Tools [144](#)

Tow starting [160](#)

Towing [159](#)

Towing fittings [159](#)

Turn signal indicator, bulb replacement [146](#)

U

Use antifreeze, radiator [130](#)

W

Warning lamps [20](#)

Warning messages [72](#)

Washer reservoir, filling [126](#)

Windshield washer nozzle adjustment [126](#)

Windshield washer reservoir, filling [126](#)

Work in the engine compartment [123](#)

Refueling

So that you will have important specifications available when you stop to refuel, we recommend that you supplement this table with data that apply to your vehicle.

Fuel

Designation	
AKI: for rated performance	91
AKI: also approved, minimum fuel grade	89

Engine oil

Quality	
---------	--

The space between the two marks on the dipstick corresponds to approx. 1.1 US quarts (1 liter).

Tire inflation pressures

	Summer		Winter	
	Front	Rear	Front	Rear
4 persons				
5 persons or 4 plus luggage				

**We wish you an enjoyable
driving experience.**



The Ultimate Driving Machine