

Owner's Manual



325i/Convertible

325is

325iX

U.S. and Canadian models only

Some equipment shown in this manual will pertain only to one model.

In Canada this manual is also available in French. To obtain a copy, contact your BMW dealer

BMW AG

Bayerische Motoren Werke
Aktiengesellschaft

In the interests of continuing technical development, we reserve the right to modify designs, equipment and accessories.

Dimensions, weights and performance data quoted in this manual are to the tolerances established by the German Industrial Standards (DIN).

Claims based on data, statements, descriptions or illustrations, errors or omissions in this Owner's manual will not be entertained.

Please note that any discrepancies between your BMW and the details given here may be due to the equipment specifications offered on a particular model or the items ordered with the car.

For operating instructions of options not listed in this Owner's Manual, please refer to the Operating Instructions or Owner's Manual for those options.

Any modification to the car and its equipment may affect its operational reliability, vehicle safety and resale value.

Important safety information!

For your own safety, use genuine parts and accessories approved by BMW.

When you use accessories tested and approved by BMW and Original BMW Parts, you have the guarantee that their suitability for your vehicle has been thoroughly tested by BMW. BMW warrants these parts to be free from defects in material and workmanship.

BMW will not accept any liability for any spare parts and accessories not approved by BMW.

BMW cannot test every product from other manufacturers to verify if it can be used on a BMW safely and without risk to either the vehicle, its operation, or its occupants.

Original BMW Parts, BMW Accessories and other products approved by BMW, together with professional advice on using these items, are available from all authorized BMW dealers.

Congratulations on your choice of a BMW.

The better acquainted you are with your car, the more pleasurable it will be to drive it. Therefore, we request that you heed the following advice:

In this Owner's Manual you will find important information concerning operating instructions, vehicle care, maintenance and technical details for your new BMW. Please read it carefully before taking your first drive, so that you are fully familiar with the technical advantages of your BMW. A comprehensive index will aid you in finding more detailed information on the various features and operations of your new car.

Please keep in mind that regular care and maintenance are necessary for the operational safety of your vehicle as well as to maintain its resale value.

This Owner's Manual should be considered a permanent part of this vehicle. It should stay with the vehicle when sold to provide the next owner with important operating, safety and maintenance information.

We wish you many safe and pleasant journeys.

BMW AG

Bayerische Motoren Werke
Aktiengesellschaft

Energy-conscious driving:

- Fuel economy is mainly dependent on your style of driving.
- Do not warm up the engine to operating temperature at idle speed and never leave the engine idling for long periods.
- Never drive up to maximum speed in 1st gear – use it only for starting off.
- Shift up to a higher gear as soon as conditions permit and try to drive in the higher and more economical 3rd, 4th or 5th gear.
- Avoid driving at full throttle for long periods.
- Avoid carrying unnecessary weight.
- Check tire pressures regularly.

Besides:

Energy-conscious driving reduces exhaust gas emissions and noise.

Warning: Use unleaded gasoline only. Fuels containing up to and including 10% ethanol or other oxygenates (e.g. ethers and ketones), or up to and including 3% methanol plus an equivalent amount of co-solvent only, will not void the applicable warranties respecting defects in materials or workmanship.

However, driveability, starting, and stalling problems may result from use of such fuels, especially under certain environmental conditions such as high ambient temperatures and high altitudes, and as a result, unscheduled maintenance may be required.

Some fuel suppliers sell fuels containing alcohol or other oxygenates without disclosing this information to the consumer. If starting, stalling or driveability difficulties occur, and are suspected to result from the fuel being used, it is recommended that you switch to a fuel known to contain no alcohol or other oxygenates. Check with the service station operator to determine if the fuel contains alcohol or other oxygenates.

Similar conditions may occur when fuels not having adequate detergency are used.

Only use fuels advertised to have deposit control additives, which keep intake and intake system clean or to "meet BMW standard of intake valve cleanliness" for either "up to 50,000 miles" or "for unlimited mileage". If such fuels are not available in your area, consult your authorized BMW Dealer, who can recommend a fuel additive that will provide sufficient detergency to assure proper engine cleanliness, when used in accordance with product instructions. Failure to comply with these recommendations may result in unscheduled maintenance.

Obey pertinent safety rules when you are handling with gasoline.

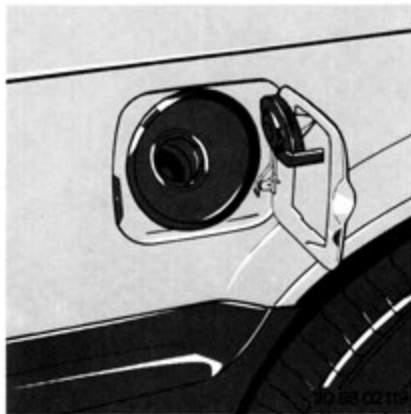

Required fuel Quality

Unleaded gasoline only
(87 AKI or 91 RON).

Filling of the fuel tank

Opening: Turn the fuel filler cap counter-clockwise and take it off.

Closing: Turn the cap clockwise to the stop (bayonet fitting).

Fuel filler

The fuel filler neck is equipped with a leaded fuel restrictor and a check valve. The restrictor prevents the insertion of fuel filler nozzles not designed for lead free fuel.

The check valve prevents the fuel vapors from escaping from the fuel tank.

Opening of the fuel filler flap in case of a failing of the central locking system:

Press back the locking rod accessible through the hole in the trunk lining on the right.

Items to check:

- Tire pressures (including spare tire), every two weeks, see page 85.
- Engine oil level, see page 51.
- Battery electrolyte level, filling up, see page 54.
- Coolant level, see page 53.
- Brake fluid level, see page 53.
- Light system, see page 60.
- Windshield washer fluid level, see page 54.

This manual is supplemented by a Service and Warranty Booklet.
We recommend that you read these publications thoroughly.

Your BMW is covered by the following warranties:

- Limited Warranty
- Limited Warranty – Rust Perforation
- Emissions – Related Defect Warranty
- Emissions Performance Warranty

Detailed information about these warranties is listed in BMW's consumer warranty booklet

“MAINTENANCE, REPLACEMENT, OR REPAIR OF THE EMISSION CONTROL DEVICES AND SYSTEMS MAY BE PERFORMED BY ANY AUTOMOTIVE REPAIR ESTABLISHMENT OR INDIVIDUAL USING ANY CERTIFIED AUTOMOTIVE PART”.

Operating instructions

Hints

Vehicle care

Technical data

Index



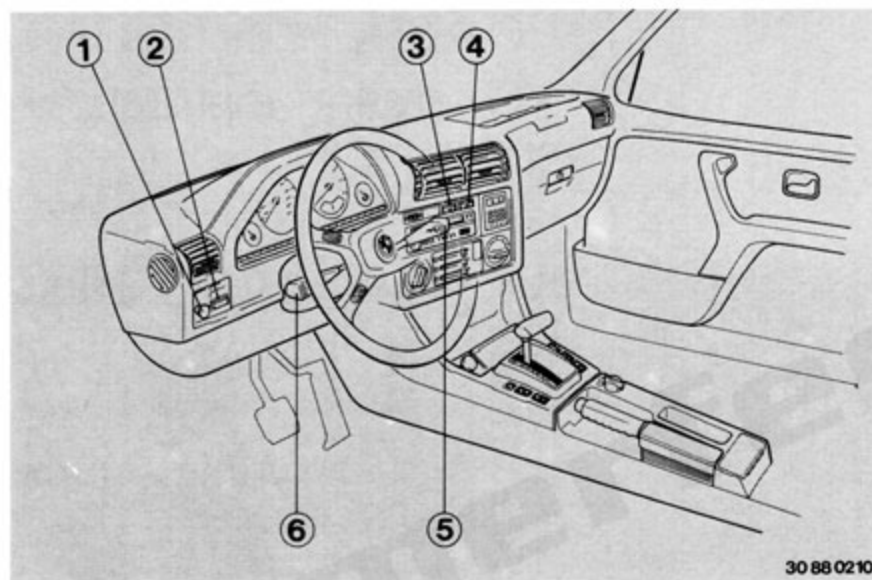

The Cockpit at a glance

1 – Headlight switch, see page 17

2 – Fog light switch, see page 24

3 – Pushbutton for rear window defogger, see page 24

4 – Pushbutton for hazard warning flasher, see page 24

5 – Windshield wiper/washer lever, see page 19

6 – Steering column lever for turn indicators, headlight dimmer, headlight flashing, see page 18

Change of On-Board Computer display, see page 36

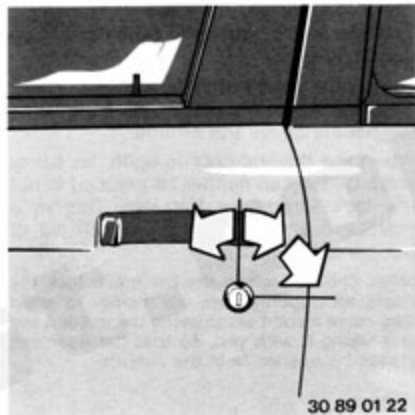
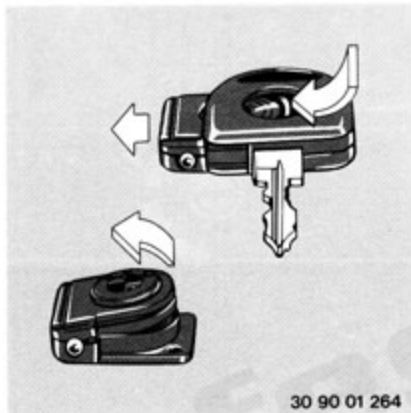
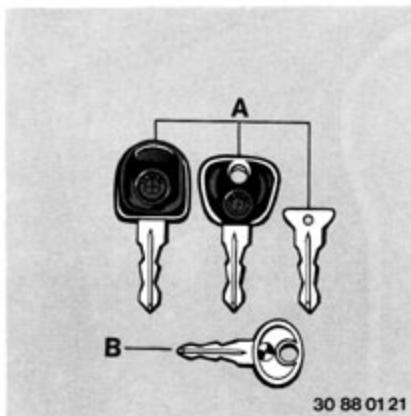

Keys

A – Master key (key for unlock inhibit system)

Key with light and battery: press button to switch on light.

- Duplicate master key.
- Spare master key with extra-small head, to be kept in a wallet or safe place.

B – Key for doors and ignition; does not fit trunk or glove box and **does not open the unlock inhibit system.**

The key number on the self-adhesive label is required by your BMW dealer to obtain duplicate keys, keep in a safe place to avoid theft.

Master key with battery light

Replace the battery when the light becomes dim.

Caution: On empty batteries acid may leak out which could lead to potential damage. Use only batteries of the specified type. Avoid environmental pollution when disposing of old batteries.

Central Locking System

Whenever the door locks or the trunk lock is operated or the safety catch button on the driver's door is pressed down, the doors, the trunk lid and the fuel filler flap locks are operated at the same time.

After an accident or severe bump the central locking system opens automatically. Reactivation follows the next locking operation.

Unlock inhibit system

By turning the driver's door key further to the right (clockwise) to a horizontal position, the central locking system activates an electromechanical locking system to further deter theft.

Note: The locking device can only be operated with the master key. Do not engage this system with passengers in the car.

To open a door from the outside: Lift up the handle.

To open a door from the inside:

First pull the safety catch button and then the handle above the armrest.

When the driver's door is open, its safety catch button can neither be pressed in nor the lock turned by the key. This is a safeguard against locking yourself out of the car accidentally.

Note: Children left in the car could lock the doors accidentally from the inside. To avoid this, make a point of removing the ignition key and taking it with you, so that the door can always be opened from the outside.

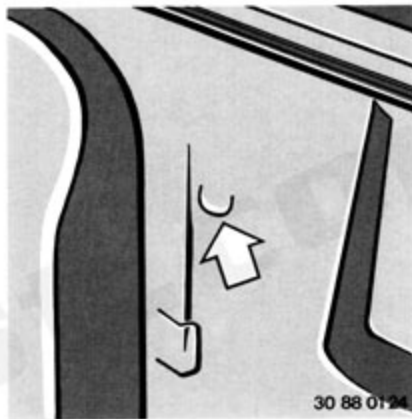
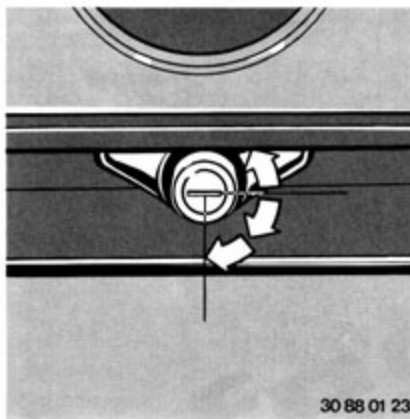

Trunk

The trunk can be locked separately with the master key, by inserting the key, turning it to the right and pulling it out in that position. After this, the trunk can only be reopened with the master key. This is useful when the luggage is to remain locked up at all times.

Note: If the trunk is opened with the unlock inhibit system in operation, it must be relocked after closing.

Trunk light

The light comes on automatically when the lid is opened.

Opening of the fuel filler flap in case of a failure of the central locking system:

Press back the locking rod, accessible through the hole (arrow) in the trunk lining.

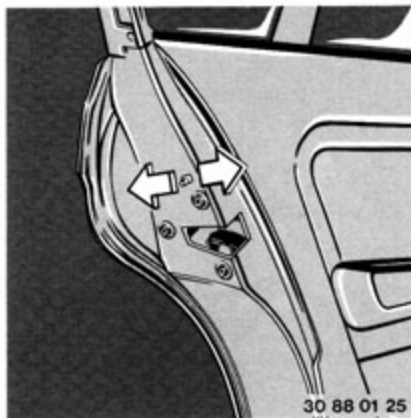

Childproof safety device
for the rear doors located next to the door catch.

Slide catch lever pushed to the inner side of the door: door can be opened from outside **but not from inside**.

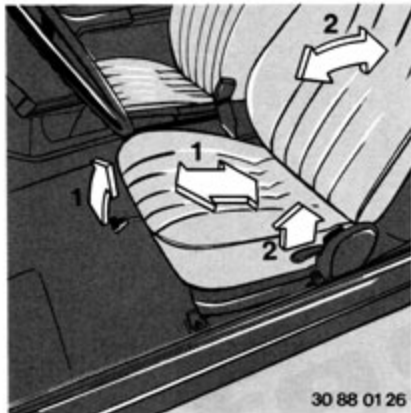

Seats

Seat adjustment

Pull up the lever (1) and exert slight body pressure to move the seat to the desired position.

Release the lever and make sure that the seat has engaged in its locking catches.

Reclining seat back

Pull up the lever (2) and exert slight body pressure to recline backward. Forward adjustment is possible by releasing the pressure.



Changing seat height

Press down the lever and relieve the load on the seat or press down on the seat while pushing back on it at the same time.

Warning: Do not adjust seat position while driving. The seat may move unexpectedly which could cause sudden loss of vehicle control and constitutes an accident risk. Passengers should not ride in a moving vehicle with the backrest reclined.

For passenger protection, seatback locks must be engaged at all times while the vehicle is in motion.



Folding seatback

On 2-door models the seatbacks are provided with safety catches. Pull up the lever to release, and fold the seatback to gain access to the rear seats. As the seatback is folded, the seat cushion also moves forward thus gaining easier access to the rear.

The headrests can be varied in height by pulling them upward or pushing them downward. The angle is varied by tilting the headrests forwards or backwards.

Headrests have to be positioned behind the head, not behind the neck.

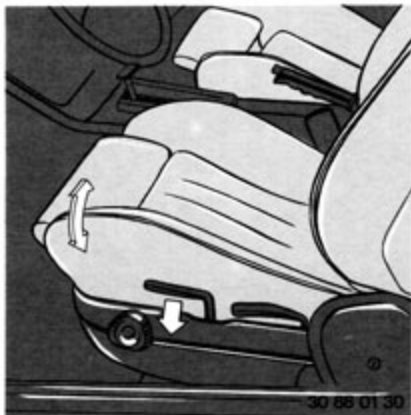

BMW Sports seat

Changing the inclination:

Press down the lever shown to change the inclination of the seat.

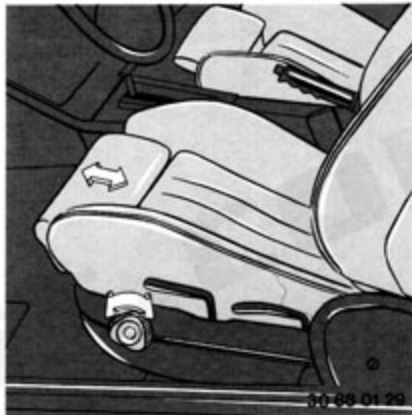

Repositioning of thigh support

Rotate the knob shown to move the front edge of the seat forwards or backwards.

All other seat adjustments are done as on the standard seat.

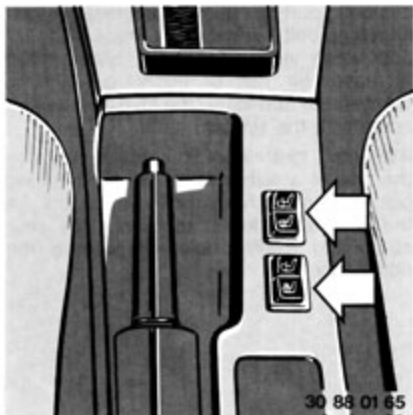

Front seat heating

The electric seat heating is operated by rocker switches with coil symbols.

Seat cushion and backrest are heated.

3 heating coils – seat quickly warms up.

1 heating coil – seat is kept warm.

Best results are obtained if the seat is heated for about 5 minutes and then kept warm.

The heating is in operation when the symbol is illuminated.



Seatbelts

Wear your seatbelts during each and every drive. The seatbelt must be locked with an audible click. To release the belt, push the red square button marked "PRESS". To store the belt, move the belt tongue to its stowed position on the door post. Pull the belt across the chest and lap and be sure that the belts are not twisted. Make sure the belt does not pass over any hard or breakable objects in your pockets or clothing. The belts automatically adjust to ensure freedom of movement.

The belt must fit tightly against the body; that is why you should not incline the seatback too far to the rear and should avoid wearing thick and heavy clothing.

Tighten it from time to time by pulling up the shoulder strap.

The reminder in the Check Control will be actuated for a time of about 6 seconds when the ignition is switched on. At the same time a chime will sound. The chime will not sound, when the driver's belt is put on before switching on the ignition.

Note: The belt locking mechanism may operate

- when taking sharp curves,
- when the car is at a steep angle,
- when pulling the belt rapidly,
- when the car accelerates or slows down.

Only secure one person (over 6 years old) with each belt. Make sure that the belt does not pass over the throat.

Do not allow the belt to rub against sharp edges.

If seatbelts or **child restraint systems** are damaged or stretched by an accident, they must be replaced completely as a safety precaution.

Have the anchor points checked by your BMW dealer.

Do not tamper with any occupant restraint system.

Care of the belts is described in Section "Vehicle care".

General remarks on seat position

Back muscles and spinal discs obtain most relief when you move right back in your seat and relax. Ideally the driver's head should be on a line forming a direct extension of the spinal column.

On long trips the seatback angle can be slightly increased, thereby further reducing the strain on the body muscles. Make sure that you are able to hold the steering wheel with the arms slightly bent.

Child restraints

All occupants and especially children should be restrained whenever riding in cars.

Children should sit in the rear and use, depending on age, either a child restraint system or the existing safety belts. Accident statistics have shown that children are safer when properly restrained in the rear seats than in the front seating positions. In the rear seat, the center position is the safest.

Infants or toddlers should be secured with a child restraint system appropriate for their size.

Children 6 years and older may wear seatbelts.

Commercially available child seats complying with the legal standard are designed to be secured with a seatbelt or with the

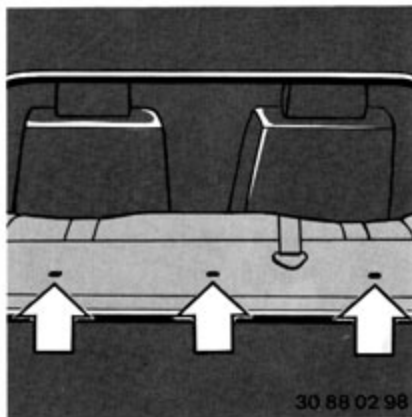

seatbelt portion of a combination lap-shoulder belt. Because improperly or inadequately installed restraint systems can increase the risk of injury to children, always read and follow the instructions that come with the system.

If the child restraint of your choice requires the use of a tether strap, three fastening points (arrow) have been provided on the rear shelf for attachment. Ask your authorized BMW dealer to perform the necessary work.

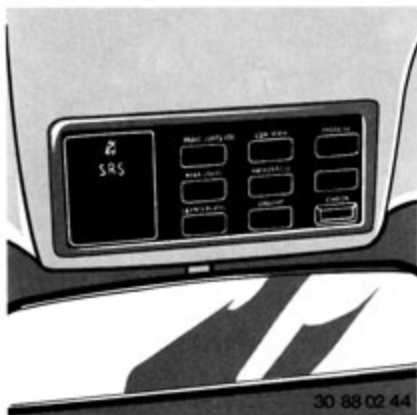

Supplementary Restraint System (SRS)

The Supplementary Restraint System which consists of an airbag, the gas generator, the crash sensors and the control unit, is designed to supplement the three-point seatbelt and to provide additional protection for the driver in the event of a serious frontal accident.

A diagnostic system continually monitors the readiness of the squib, sensors and wiring integrity of the SRS. Monitoring begins when the ignition key is turned to position 1 (and further) and continues when the car is being driven.

System is working:

The SRS indicator is illuminated for about 6 seconds and goes out.

System defective:

- indicator is not illuminated
- indicator goes out briefly after about 6 seconds and comes on again
- indicator comes on, flickers during a journey for about 5 minutes and stays on.

Have the system tested by an authorized BMW dealer as soon as possible.

Function

The airbag is mounted under the cover in the center of the steering wheel and is designed to inflate in a fraction of a second during collisions equivalent from approximately 12 mph/20 km/h and faster or frontal impacts into solid objects.

During the impact a sudden, fairly loud inflation noise will be heard and a small quantity of smoke will be released, neither of which is injurious.

Lesser impacts and those from the side and rear will not deploy the airbag, and protection will only be provided by the seatbelts.

The SRS does not replace the fastening of the seatbelts.

In connection with the seatbelt the SRS offers the best precondition for the protection of the body in case of a serious accident. Tampering and improperly performed repairs can result in a failure of the system to operate or inadvertent activation.

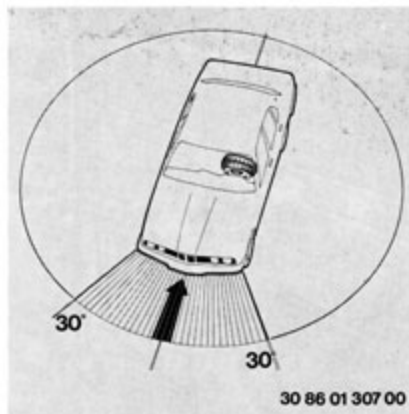

The SRS can only be activated once. Only authorized BMW dealers should repair or replace the system.

Do not affix any labels, decorations, badges etc. to the cover at the center of the steering wheel.

Should a SRS have to be scrapped, contact a BMW dealer for the safety precautions. If you sell your car, we urge you to inform the purchaser about the system and give him this manual.

At the date specified on the label on the glovebox please have an authorized BMW dealer thoroughly inspect the entire SRS.

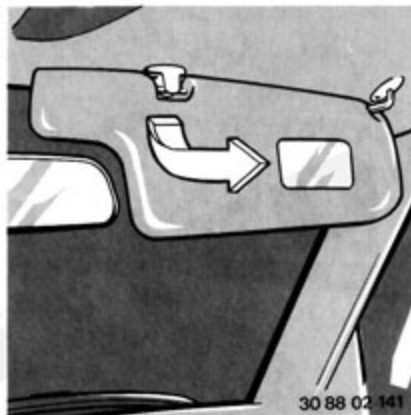
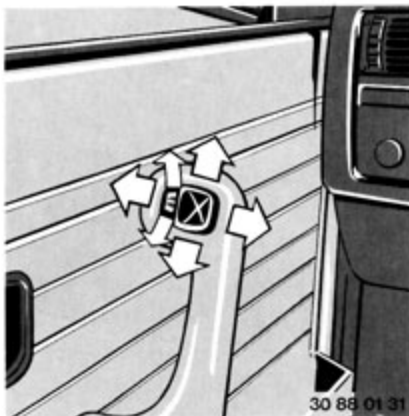

Mirrors

Outside mirror

Reposition horizontally and vertically with large mirror button.

The glass of the **wide-angle mirror** is divided to improve the range of the rearward view and eradicate the "blind spot" at the rear of the car. The outer section is convex and reflects an enlarged (but slightly distorted) rear-view area. The inner section reflects the normal rear-view area.

Electrically heated mirrors

The outside mirrors are heated automatically with ignition key in position 2.

Righthand outside mirror

The same large button is used to adjust the mirror on the other door by first moving the changeover switch (small button).

Both outside mirrors can also be repositioned manually by moving the glass.

Note: Please take into consideration that the glass of the mirror is convex. The objects you see in the mirror are closer than they appear. Do not use this mirror to estimate distance of following cars when changing lanes.

Interior mirror

The **interior mirror** can be moved to the antiglare position by means of the small lever.

Map reading lights

Switch the light on with the rocker switch. Adjust the beam by pushing the lens to the desired position.

Sun visor

Each **sun visor** can also be swung around to cover the upper part of the front side window.

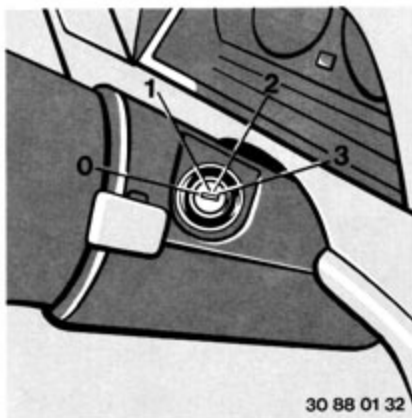

30 88 01 32

Ignition/starter switch

0 – Steering locked. The key can **only** be inserted and removed in this position. All items of electrical equipment are switched off, except for the following, which remain operational: hazard warning flashers, cigarette lighter, interior light, side/parking lights and trunk light.

To release the steering lock it may be necessary to turn the steering wheel slightly.

To lock the steering, pull out the key and turn the steering wheel to left or right until you hear the lock has engaged.

- 1 – Steering unlocked. Radio, On-Board Computer, flashing turn indicators, horn and windshield wipers can be operated.
- 2 – Ignition switched on. All other items of electrical equipment can be operated.
- 3 – Starter engages and cranks engine. BRAKE indicator light will illuminate during starting for a bulb check. As soon as the engine starts, release ignition key. It will return to position 2 and BRAKE indicator will go out.

On vehicles with automatic transmission please note that starting the engine is only possible with selector lever in position P or N.

Warning: Never run the engine in an enclosed space. The exhaust contains carbon monoxide, which although colorless and odorless is extremely toxic.

Never pull out the ignition key when the car is moving, or the steering lock will engage (the steering may need to be turned only slightly) and render the car uncontrollable.

When leaving the car unattended, take the key with you. Make sure that the steering lock has engaged. To prevent the battery from discharging, always switch off the consuming devices not in use, as well as the ignition when the vehicle is not being driven.

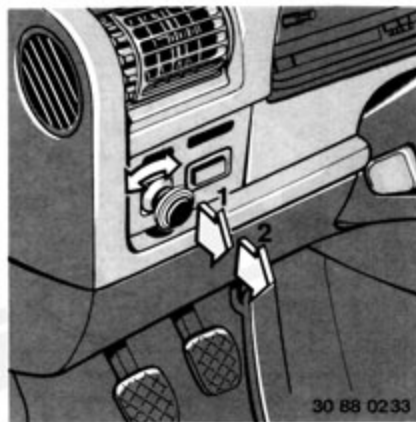

30 88 02 33

Headlight switch

Position 1: Parking lights, side marker lights.

Position 2: Headlights, parking lights, side marker lights.

If the ignition key is turned to position 1 or 0 with the headlights on, they will go out, but the parking lights and side marker lights will remain lit.

Canadian version:

With the ignition key in position 2, these lights are automatically switched on.

Instrument light

When the light switch is pulled out to either of its two positions, the intensity of the **instrument, ashtray and control identification lighting** can be varied by turning the knob.

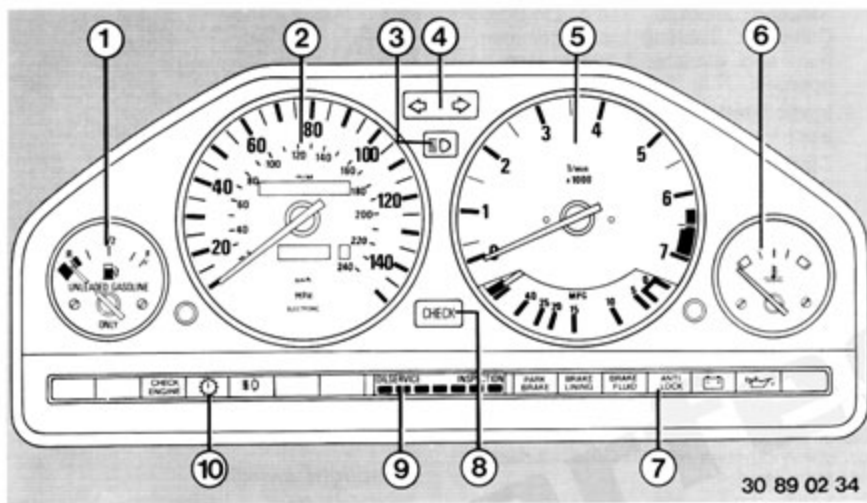

Instrument panel

- 1 – Fuel gauge with low fuel warning light
- 2 – Speedometer with odometer and trip odometer
- 3 – Headlight high beam indicator
- 4 – Turn indicator
- 5 – Tachometer with fuel consumption indicator
- 6 – Coolant temperature gauge
- 7 – Warning and indicator lights for Battery charge, engine oil pressure, Parking brake, Brake fluid, Antilock Brake System, Brake lining wear
- 8 – Central warning light for Check Control
- 9 – Service Indicator
- 10 – Fog light, emission-related indicator light and electronic shift control indicator

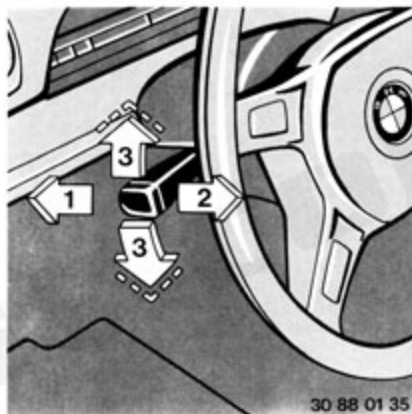

30 88 01 35

Turn indicator/Headlight dimmer switch

- 1 – Change from low beam to high beam
- 2 – High beam flasher
- 3 – Turn indicator

A ticking sound will be heard in the same rhythm as the turn indicators light up, to confirm that the turn signal is being displayed.

When you return the steering wheel to the straight-ahead position, the turn indicator lever will automatically cancel.

However to display a turn signal for a short period only – when changing lanes,

Page

- 21
- 20
- 18
- 19
- 20
- 21
- 22
- 23
- 21
- 22

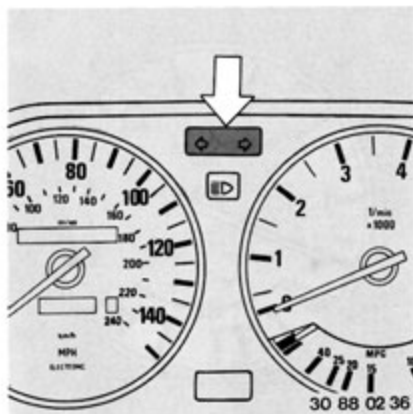

passing or pulling away from the road side etc. – you need only to press the turn indicator lever slightly away from its rest position, without allowing it to engage. When released, the lever will immediately return even if the steering wheel is not turned.

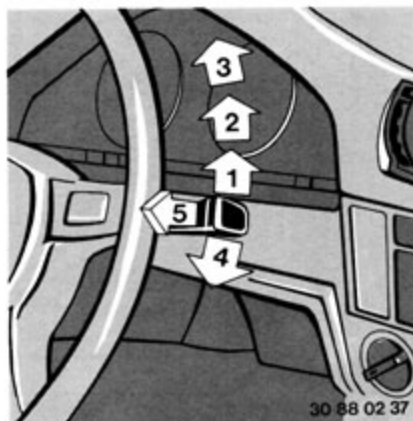

Windshield wiper/washer lever

- 0 – Wipers off
- 1 – Intermittent wipe
- 2 – Normal wiper speed
- 3 – Fast wiper speed
- 4 – Single wipe
- 5 – Automatic wash-wipe system

Warning: Do not use the washers in freezing weather without first warming the windshield with the defroster, otherwise the washer solution may freeze on the windshield and obscure your vision.

Do not operate the windshield washer when the fluid level is empty to prevent possible damage to the washer pump system.



Horn

The horns are sounded by pressing the indicated part of the pad in the steering wheel.

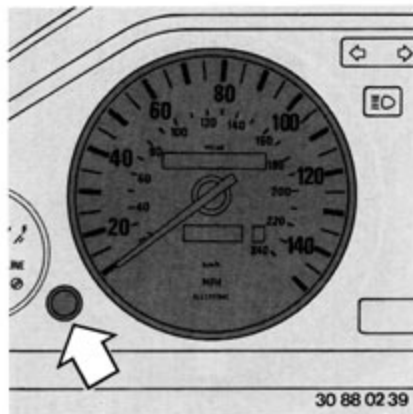

Speedometer

US model

The outer scale of the speedometer is calibrated in miles per hour. The inner scale is calibrated in kilometers per hour. The speedometer contains an odometer to show the total number of miles the car has covered.

Trip odometer

The trip odometer, which is used to record trips up to 999.9 miles can be reset to zero by pressing the knob (arrow).

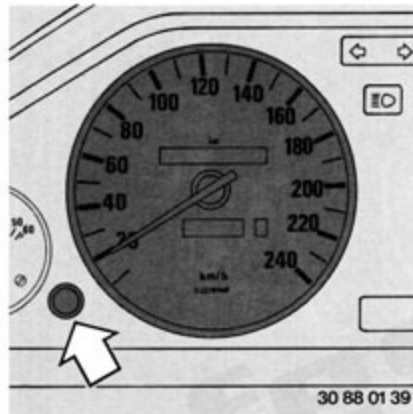

Canadian version

In this version the scale of the speedometer is calibrated in kilometers per hour.

The odometer as well as the trip odometer register distance in kilometers.



Tachometer

Avoid excessive engine speeds in any portion of the red warning zone, particularly when driving downhill or in lower gears.

The **fuel injection control unit** incorporates a cutout to limit maximum engine speed. This takes effect when the needle of the tachometer reaches the red warning zone.

Fuel consumption indicator

Above approx. 13 mph (20 km/h), you can read the fuel consumption corresponding to your style of driving at any speed. Below approx. 13 mph (20 km/h), the indicator will tend towards the zero (in Canada to the maximum) reading as speed is reduced, and will come to rest there when the car is stopped.

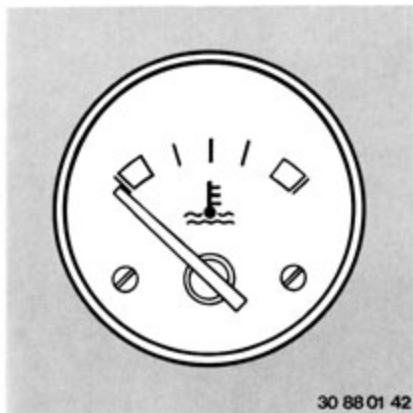

Coolant temperature gauge

Blue: engine has not reached normal operating temperature. Drive only at moderate road and engine speeds.

Red: engine overheated – pull over to a safe area out of the mainstream of traffic and stop engine immediately. Allow system to cool down until temperature gauge indicator is approx. in the middle of the scale.

Normal operating temperature is between the two colored zones. The needle may tend to reach the red zone when the ambient temperature – and/or the engine load is very high.

Check coolant level, see page 53.



Fuel gauge

If the yellow low fuel warning light comes on, there are approx. 1.6 gal./6 l fuel left in the tank.

Fuel tank capacity, see page 84.

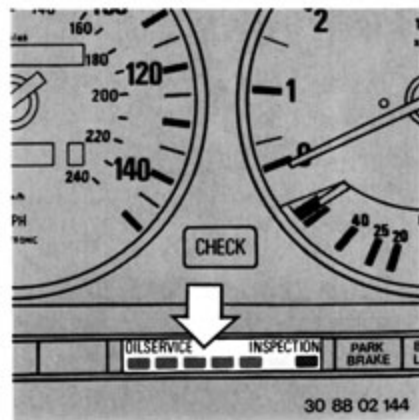

Service indicator

Green lights

As the number of illuminated green lights becomes less, this is an indication that the next service is due shortly.

The green lights go out when the engine is started.

Yellow light

If the **yellow light** and one of the inscriptions, OIL-SERVICE or INSPECTION, also comes on with the ignition and remains on when the engine has been started, the next service routine is due.

Red light

The maintenance interval has been exceeded.

Resetting is done after maintenance.

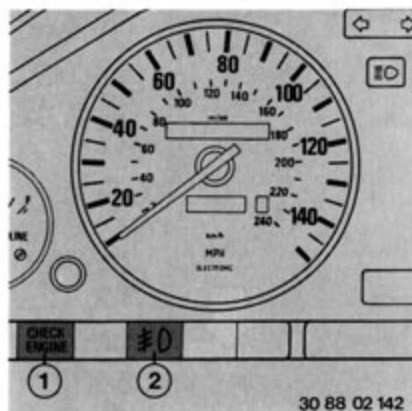

Indicator and warning lights

1 – Emission-related indicator

Light goes out after engine has started. If the Check Engine indicator lights up or flashes the engine still can be driven but the emission-related electronics should be inspected.

2 – Fog light indicator

If fog lights are fitted and switched on the light comes on.

3 – Parking brake indicator

Light goes out after engine has started. The parking brake indicator in the dash comes on before the engine is started as a check and will come on when the parking brake is applied.

4 – Brake lining wear indicator

Comes on when the starter cranks engine and goes out after engine has started.

Minimum brake pad thickness is also indicated by means of a red brake lining wear indicator light in the dash. As a check this light comes on in ignition key position 3 when the engine is started.

If the light comes on have the brake pads inspected without delay.

5 – Brake fluid level warning light

Light goes out after engine has started.

If the red brake warning light comes on while the car is being driven, this is a sign that brake fluid has been lost. If the brake pedal travel at the same time increases considerably, one hydraulic brake circuit has failed.

We recommend that you have all problems in the brake system examined and repaired immediately.

6 – Antilock Brake System warning light

Light goes out after engine has started.

If the antilock warning light comes on when the car is in motion at normal driving speeds, this indicates that the antilock braking system has developed a fault and is out of action. Although the antilock braking effect is then lost, normal brake applications can still be made.

7 – Battery charge indicator

Light goes out after engine has started.

If the **battery charge indicator** comes on during a trip, have the car checked to determine the cause of the problem.

If the V-belt that drives the alternator and coolant pump is defective, the battery may

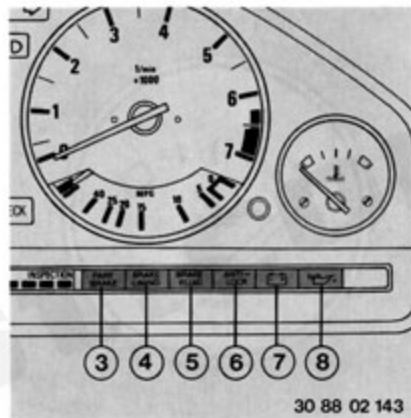

eventually discharge completely. The coolant pump will be inoperative and overheating could cause engine damage. Contact your authorized BMW dealer.

8 – Engine oil pressure warning light

Light goes out after engine has started.

If the red engine oil pressure warning light comes on while driving, pull off the road to a safe stop and declutch or select neutral immediately and switch off the ignition. If the engine oil level appears to be incorrect, do not drive the vehicle. Operating the vehicle with low or no engine oil pressure will cause severe engine damage.

If the warning light comes on briefly at idle speed this should cause no alarm provided that it goes off when the accelerator is partially pressed down.

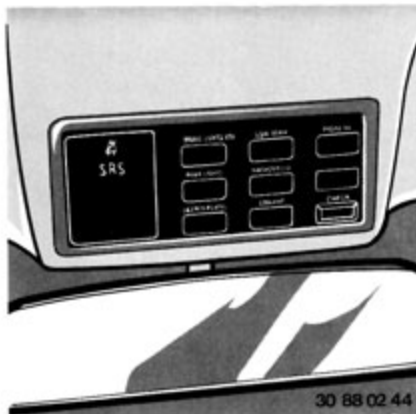

Check Control

The functions of

- License plate light
 - Brake (stop) lights
 - Low beam
 - Rear lights
- and the liquid levels of
- Coolant
 - Washer fluid
 - Engine oil
- are checked.

Ignition/Starter switch position 1:

Any reduction in engine oil, coolant or windshield washer fluid level is indicated by the inscription panel being illuminated, and the appropriate LED coming on.

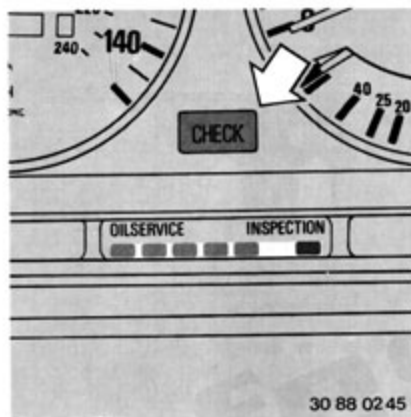

Ignition/Starter switch position 2:

The central warning light on the instrument panel will flash. At that same time, all Check Control inscriptions light up, together with the "Brake lights" warning light.

If the engine is started and the car's lights turned on, any malfunction can be identified immediately by means of the appropriate warning and indicating lights.

If the brake pedal is depressed, the central warning light, the "Brake lights" warning light and all Check Control inscriptions should go out if the corresponding systems are in proper working order.

CHECK indicator light flashing while driving

Warning light for the faulty systems in the Check Control lights up.

Switch off CHECK indicator light:

Press CHECK button.

When the CHECK button is pressed, all the warning lights will come on, but when released only those indicating a genuine system malfunction will remain on.

Top up fluid levels if too low at the earliest opportunity.

If the engine oil level is too low, this indication remains stored in the Check Control memory until oil is added.

Immediate attention is necessary and, for road safety, any malfunction of the car's light should be rectified (brake lights).

Rectify malfunctions as following

- **Brake (stop) light operation:** Replace the appropriate electrical fuse or brake light bulb.
- **Low beam operation:** Replace the appropriate electrical fuse or the sealed beam.
- **Engine oil level:** Check level and if necessary add fresh oil of the same grade.
- **Rear light operation:** Replace the appropriate electrical fuse or the bulb.
- **Washer fluid level:** Top up the windshield washer fluid tank and if necessary restore the concentration of the antifreeze.
- **License plate light operation:** Replace the appropriate electrical fuse or the bulb.
- **Coolant level:** Check level and fill up if necessary. Afterwards check the concentration of the long life antifreeze and corrosion inhibitor.

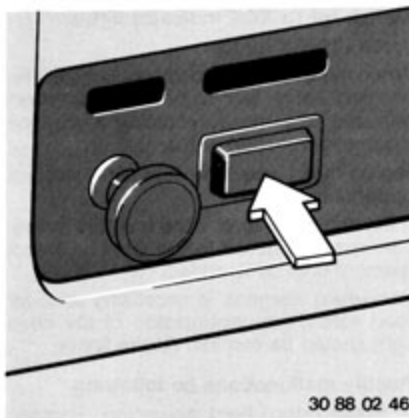

30 88 02 46

Fog light switch

To switch on the front fog lights, press in the pushbutton.

Whenever the front fog lights are in use, the indicator on the instrument panel comes on.

Please note local regulations with regard to the use of fog lights.

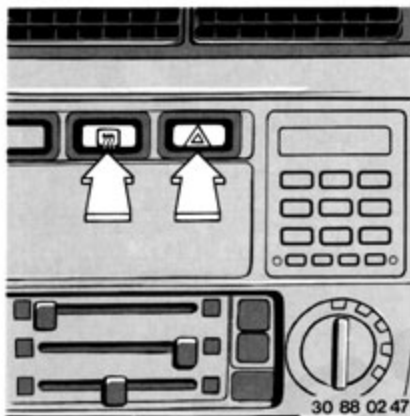

30 88 02 47

Hazard warning flasher

The hazard warning flashers are operated by the pushbutton with the "triangle" symbol; its red telltale flashes rhythmically when the hazard warning system is in use.

When the car's lights are turned on, a bulb illuminates the pushbutton switch.

Rear window defogger

When the heated rear window is switched on, the pushbutton is illuminated.

The electric heating elements on the rear window ensure unrestricted vision to the rear and help to prevent or remove fogging or ice build-up in freezing conditions.

The electrically heated rear window ventilation **on the convertible** is located behind the rear seatback.

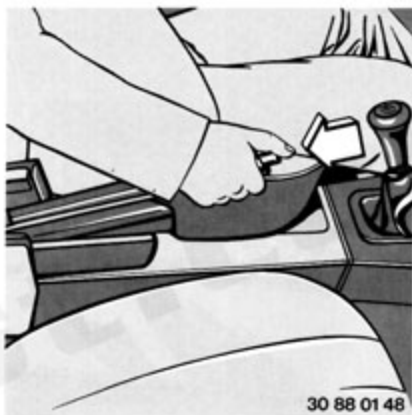

30 88 01 48

The blower and the heating are turned on and off by pressing the switch. When the soft top is open, rear window ventilation is put out of action by a safety switch on the soft top mechanism.

Parking brake

The parking brake operates on the rear wheels. To stop the vehicle and prevent it from moving pull the parking brake lever up. To release the lever, pull it up slightly, press in the knob and push the lever down.

When the parking brake is applied the indicator in the instrument cluster will come on. Using the parking brake when driving, apply brake lightly to avoid break out.

Manual Transmission

The fifth gear is an economy gear, reducing engine speed and noise level (compared with fourth gear) while maintaining road

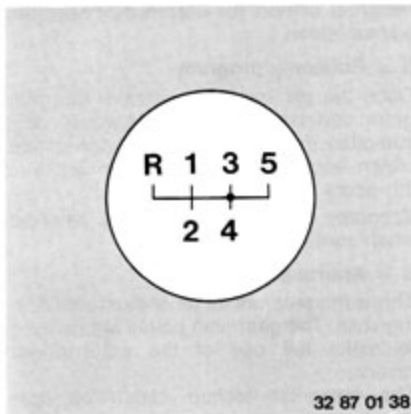

speed, and may contribute to fuel consumption reduction.

All gears have synchromesh. The gear lever automatically slips back into neutral position between 3rd and 4th gears (indicated by the dot on the shift pattern) when a gear is not engaged.

Shifting back from 5th to 4th gear at high speeds increases engine rpm and can cause damage.

Selecting reverse gear

It is advisable to select reverse when the car is at a standstill.

The **backup lights** will come on when the reverse gear is selected and the ignition is switched on.

Warning: Do not use the gearshift in place of the parking brake. Premature clutch wear will occur when holding the car on a steep hill with the clutch pedal partially depressed.



Automatic Transmission

The following **selector lever positions** are available for various traffic conditions.

P - R - N - D - 3 - 2 - 1

The lever position selected is shown by symbols on the selector lever gate.

For engine starting, move selector lever to position P or N.

On the **electronic-hydraulic transmission**, 3 shift programs can be selected at the **program switch**:

E (Economy)
S (Sports)
3 · 2 · 1 · (Manual)

Please note that starting the engine is only possible in selector lever position P or N.

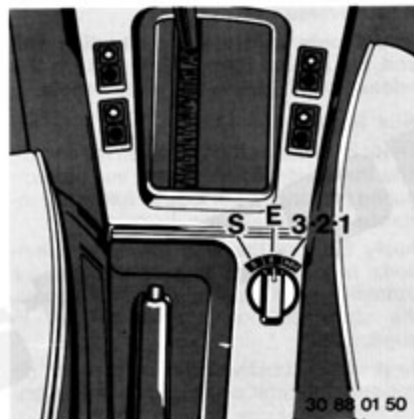

Pull up the release catch (arrow) under the lever handle if necessary, when moving the selector lever.

Important: after selecting any lever position, wait for the transmission to engage especially at low temperatures (slight drop in engine speed) before accelerating.

The car crawls if the engine is running at idle speed and a drive gear is engaged.

Before leaving the car with the engine running, first select P or N at the selector lever and apply the parking brake.

P = Park
Select only when the car is standing still.

The transmission is locked in this position as an additional precaution against rolling away.

R = Reverse

Select only with the car standing still and the engine idling. First pull up the release catch below the lever handle.

N = Neutral

There is no connection between the engine and the transmission. Select this position during **prolonged periods of idling** (for instance in traffic jams).

Apply the foot brake to prevent unintentional rolling of the car. At short stops, for example, when waiting at traffic signals, the drive position should be left in engagement.

To prevent excessive clutch plate wear, do not select neutral when driving unless absolutely necessary (e.g. to prevent skidding).

If it happens accidentally release the accelerator immediately and select the new position.

D = Drive (automatic gear selection)

This is the position for all normal driving. The car starts in 1st gear and shifts up automatically.

The 4th speed range is designed as an overdrive, to reduce engine speed, engine noise and fuel consumption once a steady road speed has been achieved.

3 = Direct drive position

If under certain driving conditions in city or high way driving automatic gear changing (4-3-4) occurs shift to position 3.

If increased performance is needed, shift to this range.

Gear shifting will be limited to gears 1, 2, 3 and reverse.

2 and 1 = Hill-climbing and engine braking

These positions may suit the driver better on mountain roads or very long uphill and downhill gradients. It makes better use of full engine performance and the engine's braking effect.

Position 2 and 1 can be selected at any speed, after releasing the safety catch under the handle. However, the transmission will not shift down immediately into 2nd and 1st as this would cause excessive engine rpm.

Note that once position 2 or 1 has been selected, the transmission will no longer shift up to a higher speed range, even if this means that the engine speed can become excessive.

"Kick-down"

After reaching the normal full-throttle position, the accelerator pedal on automatic transmission cars can be depressed further by overcoming the detent.

This will enable maximum acceleration to be obtained immediately by selection of lower gears.

After the kick-down has been operated, the next upward shift will occur only at a much higher engine speed than usual.

For towing and starting with a dead battery, see pages 56, 57.

Program switch for electronic-hydraulic transmission**E = Economy program**

Once the car has been started, this program can be selected for low-fuel consumption motoring. The converter lockup clutch engages automatically in 3rd and 4th gears.

Economy mode is automatically selected when starting the engine.

S = Sports program

This is the program for an enthusiastic driving style. The gear shift points are delayed to make full use of the car's power reserves.

The converter lockup clutch engages automatically in 3rd gear, 4th gear is locked out of use.

3 · 2 · 1 = Manual program

The indicator lights up when selecting this program.

The program is for single-gear driving (3rd gear if D is selected). The gear selected is also used for pulling away.

Note: Electronic shift control  comes on if the electronic shift control circuit has failed. The transmission selects 3rd gear irrespective of the selector lever position. The car can be driven normally. Consult the nearest BMW dealer (avoid high engine loads). Before leaving the car make sure the gear selector lever is engaged in P (Park) and set the parking brake. Unexpected and possibly sudden vehicle movement may occur if these precautions are not taken. Never have any driving position engaged when checking under the hood. Never leave children unattended in the vehicle.

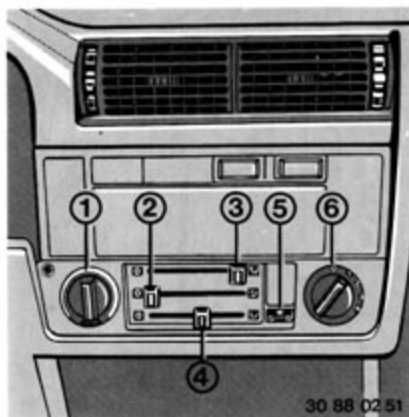

Heating and ventilation

The controls are arranged as follows:

- 1 – Temperature control
- 2 – Slide control for center air entry
- 3 – Slide control for air distribution to defroster outlets
- 4 – Slide control for air distribution to lower part of interior (footwell)
- 5 – Pictogram-shows control setting for maximum windshield defrosting
- 6 – Blower speed control

Entry of variable-temperature air

Depending on the temperature setting, warm or fresh air is supplied to the passenger compartment through all the grilles and outlets.

The air outlet grilles above the controls and at the left and right of the dashboard can be turned horizontally and vertically, or closed by turning down the knurled wheels at the side of the grilles.

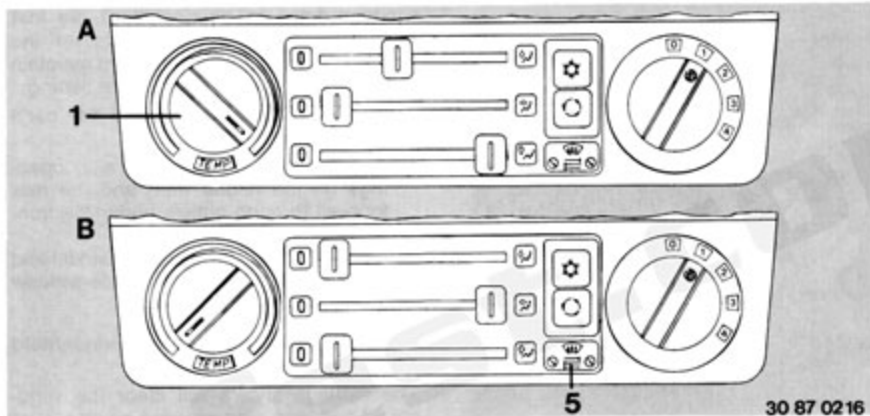

1 – Temperature control

The temperature of the air entering the car can be increased continuously by turning this control clockwise. The selected temperature will be reached shortly afterwards.

Automatic temperature control

The temperature scale acts as a guide when adjusting the control to obtain a pleasant interior temperature. This temperature will then be reached after starting the journey, and no further adjustment of the temperature control should normally be necessary.

Preferred rotary temperature control respectively rotary blower switch positions:

Winter (drawing A):

For warming up the interior the rotary temperature control (1) is to be turned clockwise to maximum position.

The rotary blower switch position may be chosen to your needs, but switch position 1 is the minimum blower speed to be taken.

Maximum heating performance can be obtained with the engine at operating temperature, turning the temperature switch clockwise to maximum temperature and blower switch in position 4 and all slide controls pushed to the right side.

Summer (drawing B):

Air distribution upwards and/or downwards can be chosen to your needs.

2 – Slide control for center air entry

As the lever is slid from the left (closed) to the right (fully open), an increasing amount of air is directed for distribution through the various air outlet grilles.

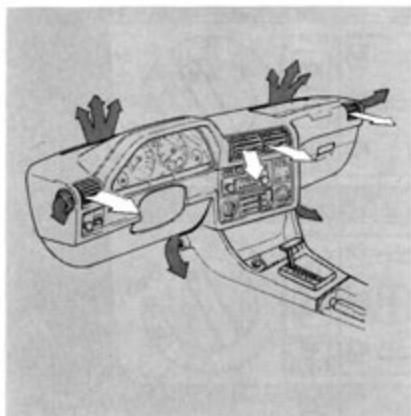

Warm air



Cool air



If the footwells are supplied with heated air at the same time, warmer air reaches the footwells according to the setting of rotary temperature control 1, and blends with the cooler air to provide a pleasant, stratified temperature pattern inside the car, e.g. to allow cooler air to be directed at the driver's head to help reduce fatigue.

3, 4 – Slide control for air distribution

By moving these levers from the left (closed) to the right (fully open), the desired pattern of variable-temperature air can be obtained and continuously varied as required.

The lower air distribution lever should always be left at least half open (unless the

windows have to be defrosted), so that the temperature sensor can deliver the necessary warmer or cooler air to maintain the chosen constant-temperature setting. Variable-temperature air enters the car's interior:

- in the front footwells, from side openings on the heater unit, and the rear footwell through outlets under the front seats.
- for defrosting, through two windshield outlets and two outlets for side-window defrosting.

5 – Pictogram for maximum windshield defrost settings

The settings shown will clear the windshield and front side windows as rapidly as possible if iced over or fogged up.

After defrosting the windshield, side window defrosting can be speeded up by closing the upper air distribution control slightly, opening the center air entry grilles at its lever and also the left and right grilles, and directing the airflow from these towards the side windows.

Air extraction

Stale air is extracted through slots below the rear window and trunk and openings next to the rear bumper.

Warning: Do not put anything on or near the windows that may interfere with the driver's vision.

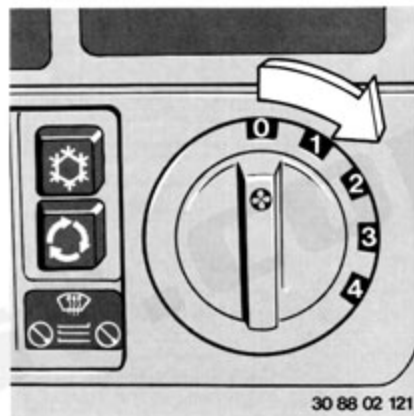

30 88 02 121

6 – Blower speed control

This enables the volume of air entering the interior to be varied; the flow is boosted when the control is turned clockwise.

Blower positions are as follows:

- 0 = off
- 1 = very low
- 2 = low
- 3 = medium
- 4 = high

It is recommended to run the blower whenever heating or ventilation is required, particularly at low or extremely varied speeds.

Do not use blower speed 4 with the rotary temperature control at maximum heat until the engine has reached its normal operating temperature.

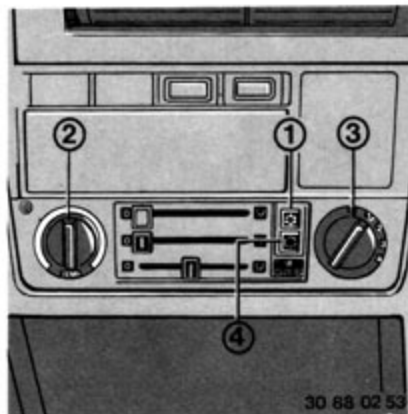

Air conditioning

The air conditioning is integrated into the standard heating and ventilation systems, with the same air outlets and controls.

The slide control levers have no influence on the function of the air condition.

1 – Air conditioning on/off pushbutton

The air conditioning only operates above a temperature of 5° C (41° F), measured by a sensor at the evaporator. A lamp in the button comes on when the air conditioning is switched on.

2 – Temperature control

With the air conditioning switched on, cooled air enters the car from the "nine o'clock" setting of this control onwards, followed by air which has been gradually heated and therefore dried.

Important: at maximum air conditioning output, avoid distributing air through the upper outlets, or else the windshield may ice over on the outside.

If humidity inside the car is high, switch on the air conditioning and turn the rotary temperature control to a moderate setting, with the blower at 2 to 4, to prevent the windows from fogging over inside.

3 – Blower speed control

This permits the volume of cool air entering the car to be varied. Turning clockwise boosts the airflow.

When the air conditioning is switched on, a small amount of cool air enters even at blower switch position 0.

4 – Recirculated air pushbutton

This cuts off the fresh air flow from outside the car, for instance to eliminate unpleasant odors, and is also used for maximum cooling of the car's interior.

Note: Do not drive too far with the recirculated air position selected, as the quality of the air inside the car gradually deteriorates.

Any condensation which forms at the evaporator is discharged underneath the car.

Important notes:

- The air conditioning system operates only when the engine is running.
- When the air conditioning is switched on, at least one air outlet grille must be open, or else the evaporator may ice up.
- The air conditioning should be run briefly at least once a month. This is particularly important during the cold season of the year, to prevent the compressor shaft seals from drying out and allowing refrigerant to escape.
- If any malfunction of the air conditioning is noted – for instance no cool air output after switching on – the system should be switched off at once and the car taken without delay to an authorized BMW dealer.

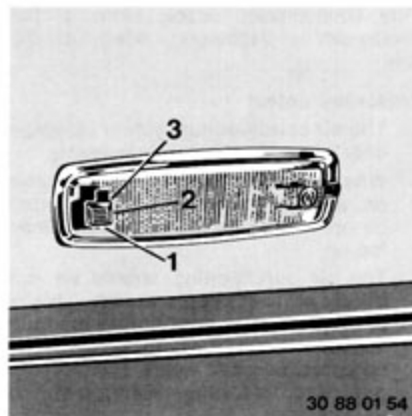

Interior light switch

Position 1: light is on only when a door is open.

Position 2: light permanently off.

Position 3: light permanently on.

The **interior light** is automatically switched on by lifting the driver's door handle. The interior light remains on for about 6 – 8 seconds after the doors have been closed, but goes out when the ignition is switched on.

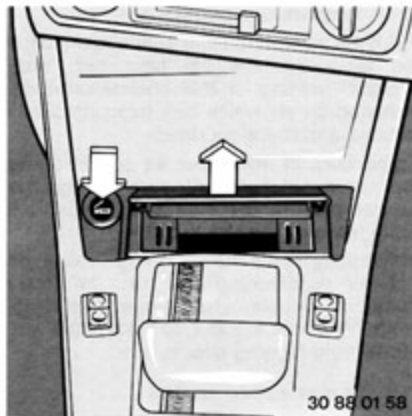

Cigarette lighter

To use the **cigarette lighter**, press in the knob. When the heating element has become sufficiently hot, the knob will pop out and the lighter can then be removed from its socket.

The **power socket** can also be used to plug in a hand lamp, electric shaver or similar appliance rated at not more than 200 Watt, 12 Volt. Make sure that the socket is not damaged by attempting to insert plugs of the wrong pattern.

Warning: Cigarette lighter and socket remain functional after the ignition key is removed. Therefore, never leave children inside the vehicle unattended.

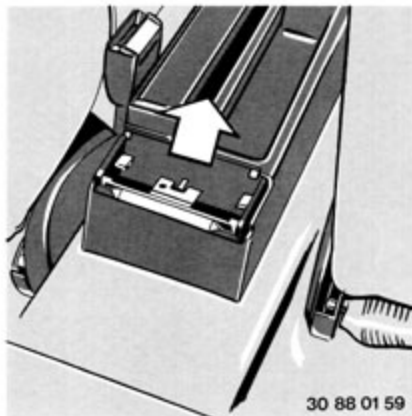

Front ashtray

To clean the front **ashtray**: open the flap and pull the whole assembly up.

To extinguish the cigarette use the funnel in the ashtray.

Warning: Never use ashtrays as litter bins. Fire hazard!

Rear seat ashtray

To clean the ashtray: pull out fully, press the leaf spring down and take out the ashtray.

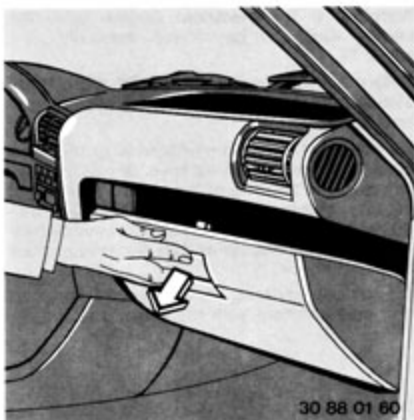

Glove Box

The lockable glove box is opened by pulling the recessed handle and closed by pushing the lid up firmly.

When the glove box lid is open, the glove box light will come on and the **rechargeable flashlight** can be reached. The flashlight has a built-in overload device and can thus remain plugged in at all times so that it is fully charged whenever needed.

Warning: Do not plug the lamp in while it is still switched on. To reduce the risk of personal injury in an accident or sudden stop, keep glove compartment closed while driving.

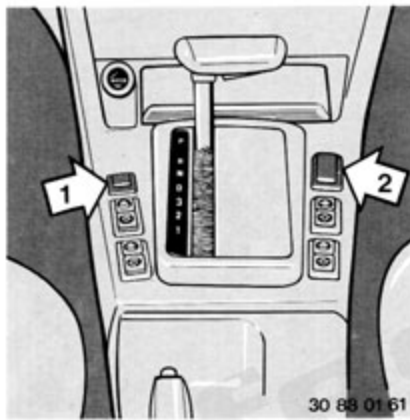

Electric window lifts

The electric window lifts are operated from the pushbuttons on the center console, when the ignition switch is in position 2.

There are additional switches under the rear side windows to operate them separately, but these can be isolated with the driver's Circuit Breaker (arrow 1), for instance to prevent children from playing with the windows.

Automatic Circuit Breaker

An automatic circuit breaker (arrow 2) and a fuse protect the electric window motor by tripping in the event of a fault or overload.

The electric windows are not operational when the ignition key is removed, to prevent children left in the car from operating the windows and perhaps injuring themselves.

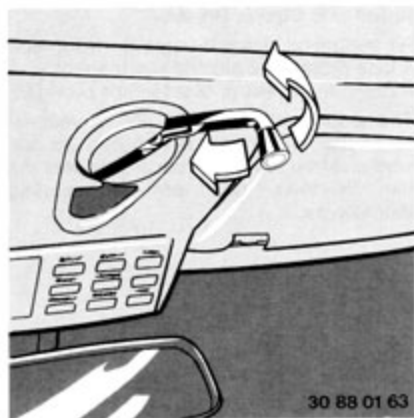

Sliding sunroof

To open: unfold the crank handle and turn it counterclockwise past the point of initial resistance until the roof panel slides open.

To close: turn the hand crank clockwise so that the roof panel moves forward.

Raising the rear of the closed roof panel: unfold the crank handle and turn it clockwise until initial resistance has been overcome and the rear end of the panel begins to rise.

Lowering: turn the crank handle counterclockwise. The roof panel is closed when distinct resistance to further rotation of the crank handle has been overcome.

Important: fold the crank handle back into its recess after use.

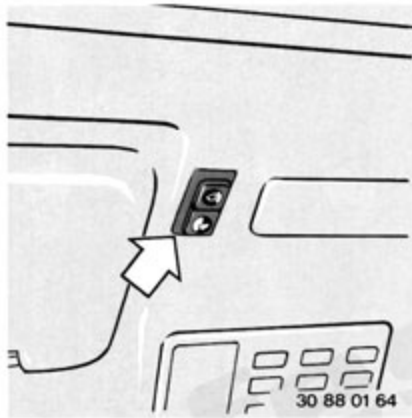

Electrical operation

To lower or open (sliding back): push the rear button.

Raising the rear of the panel or closing the roof (sliding forward): push the front button.

Sliding and elevating operations are separated by an electrical changeover switch. After the roof has been slid shut, the drive motor will cut out automatically. If the roof is to be raised at its rear immediately after sliding closed, the switch must be pressed a second time. The same applies when changing over from lowering to sliding open.

To avoid unpleasant draughts or vacuum when driving with an opened or raised sunroof do not close airflow through outlets. If necessary increase the amount.

Warning: If the electrical system fails, the sliding roof can be closed manually. See page: 59.

Before leaving the car, switch off the electric sliding roof mechanism by taking out the ignition key.

Do not leave children unattended in the vehicle with access to vehicle keys. Use of the keys can result in starting of the engine and use of vehicle systems such as electric power windows, electric power sunroof, etc. Unsupervised use of these systems can result in serious personal injury.

Do not put anything on or near the windows that may interfere with the driver's vision.



Automatic cruise control

This system allows adjustment for a constant cruising speed in the speed range above **25 mph** or **40 km/h**.

1 ACCELERATE

Tapping the lever: Speed will be held and memorized. With each tap the speed is increasing for approx. 0.7 mph/1 kmh.

Holding the lever in this position: Your vehicle accelerates without using the accelerator pedal. After releasing the lever the achieved speed will be maintained and memorized. The controlled speed will be interrupted and has to be resumed if the memorized speed has exceeded 7 mph/10 kmh for longer than one minute.

2 DECELERATE

Holding the lever in this position: Your vehicle decelerates automatically if cruising with controlled speed.

After releasing the lever the achieved speed will be maintained and memorized.

Tapping the lever: Decelerating for approx. 0.7 mph/1 kmh when cruising with controlled speed.

3 RESUME

Tapping the lever: The last memorized speed will be achieved and maintained.

4 OFF

By tapping the control lever in a downward direction the cruise control can be switched off in any driving and operation condition. The "memorized" speed is cancelled by switching off the ignition. The cruising speed control is automatically switched off in any operation when using the footbrake, the clutch, by moving the gear selector lever from D to N, or if the deceleration rate is excessive, for instance on a steep up-grade.

Warning: Never use the automatic cruise control if:

- you are in heavy traffic
- the road is winding and where a constant speed cannot be maintained
- the road surface is slippery – rain, snow, ice
- the road surface consists of a loose driving surface – gravel, dirt, sand

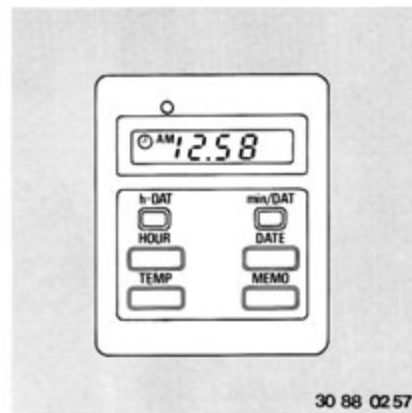

Ambient temperature display and digital clock

The ambient temperature display and digital clock provides the useful information of time, date and ambient temperature, and, additionally, an hourly time reminder. The display brightness is automatically controlled and will vary with the amount of outside light.

At ignition key position 0 and beyond, date and time will be displayed after pushing the appropriate button.

At ignition key position 1 time is displayed, and inputs and changes can be entered.

Input of date and time:

When the power supply has been interrupted (flashing dot), time can be entered by means of the two buttons h/DAT and min/DAT without pushing the function button (HOUR).

The function time is displayed by a clock symbol, date is displayed with the word DAT.

The input of figures can be done regardless of a fixed numerical sequence.

When a number is entered, the number stored in the memory is erased.

When a numeric button is pushed and held, after every half second, the corresponding numerical input goes up by one.

The clock and calendar functions start to operate as soon as the respective HOUR and DATE button have been pushed (the dot stops flashing). Before any other input or before a change push the appropriate button (HOUR/DATE) for 3 seconds until a flashing dot appears between hours and minutes display, respectively months and days.

If an input is not stored but another function chosen, the input formerly stored is preserved.

The memory will not accept unrealistic value inputs. The numerical display always has to begin with a number other than 0. The date display disregards leap-years and must be corrected manually as appropriate.

24 or 12 hour time-input:

The alteration from AM to PM occurs after pushing the h/DAT button until 12 hours have run through and PM appears in the display.

In order to obtain a 24 hour and °C, 12 hour and °F or 12 hour and °C display, the switch at the backside of the clock can be reset by your BMW dealer.

When switching over from 24 hour to 12 hour display an automatic change in the function of the min/DAT button from day/month to month/day occurs.

When pushing the button MEMO, the time reminder is activated. A signal will sound 15 seconds before each full hour. This is to remind you of an hourly newscast as an example. The function is also indicated in the display by the letters ME.

Temperature:

The ambient temperature is displayed when the button TEMP is pressed. At ignition key position 1 and beyond a warning signal sounds, when the ambient temperature is below +3° C (37° F). At the same time the unit of measurement (° C/° F) and the dot will flash for 10 seconds. If another function is chosen during this time and the temperature display is selected again afterwards, only the visible warning occurs. The warning signal sounds again when the temperature increases to +6° C (43° F) at least once since the last warning signal and again drops below +3° C (37° F).

Warning: The outside temperature display is not an indicator for possible ice on the road. Ice can form or remain even at temperatures above freezing.

On-Board Computer

The On-Board Computer can supply the following information for safe and economical driving:

- Time or date HR-DATE
- Average speed AVG MPH
- Speed limit warning M MPH
- Average fuel consumption AVG MPG
- Range on remaining fuel RANGE
- Stopwatch TIMER
- Outside (ambient) temperature TEMP.
- Vehicle immobilization for anti-theft protection CODE

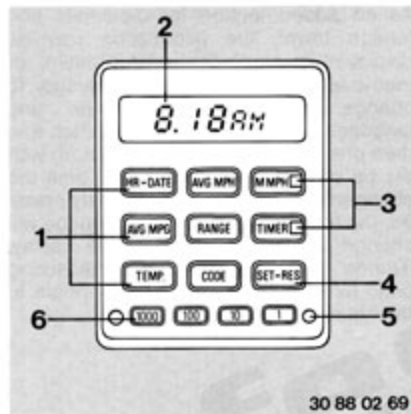

- 1 - Information buttons (rows 1-3)
- 2 - Digital display
- 3 - Light-emitting diodes (LEDs)
- 4 - "Start-Stop" button
- 5 - Changeover contact
- 6 - Four numerical input buttons (row 4)

The computer is ready for use at ignition key position "1" and beyond.

For safety reasons, always **input information before** beginning a trip or with the vehicle at a standstill.

Press the appropriate "information button" to obtain the following displays:

- Average speed
- Average fuel consumption
- Range on remaining fuel
- Outside temperature

The selected information display will remain on until another display button is pressed.

After pressing one of the information buttons, press the SET-RES button (4) to reset the computer to begin recomputing

- Average speed
- Average fuel consumption
- To start and stop the stopwatch function

The entering of numerical inputs for:

- Time/Date
- Speed limit warning
- Vehicle immobilization for anti-theft protection

are described on the following pages.

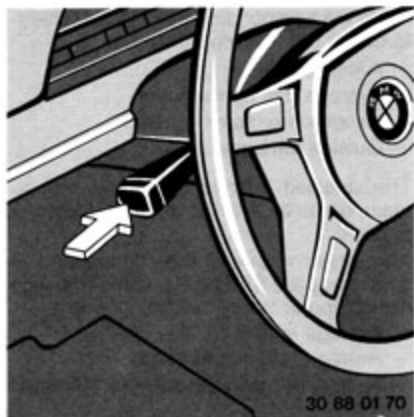

Press the appropriate information button to obtain a new information display.

By pressing the turn signal lever in the direction shown in the figure, the display will change to the next function.

Press the turn signal lever consecutively until the desired function is displayed.

As an added feature for diplomats and foreign travel, the information can be displayed in U. S., imperial (British), or metric units of measure and language. To change the units of measure and language, press the AVG MPG button and then press the changeover contact (5) with the tip of a ball point pen. Each time the changeover contact is subsequently pressed, the units of measure and language will change and will be shown on the display. (During the changeover, the measuring units for fuel consumption appropriate to the country are displayed.)

If the power supply to the On-Board Computer is interrupted during electrical repairs, e. g. changing a battery, all data stored is erased from the memory and the units of measure and language will change automatically to metric.

When the supply voltage is restored, the units of measure should first be selected, then the time, date, and if desired, the speed limit programmed as outlined on the following pages.









Should the display indicate AAAA or PPPP, contact your dealer.







Input and information display

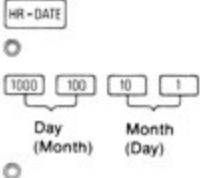

Use these buttons to program the digits in the display as outlined on the charts below. The memory will not, however, accept unattainable inputs such as a 13th month, etc.

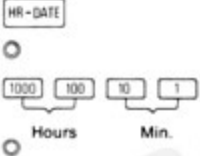
When a digit is entered, the previous digit stored in the memory is erased. Digits can be changed individually and in any order. When a button is pressed (or after each half second if the button is held in), the corresponding display digit increases by one digit.

Function	Input: press buttons in the sequence shown below	Information display: Press button shown below for display of function desired	Notes: Programming information and display description
Change of language and units of measure	 <input type="radio"/> Changeover contact (5)	According to input	Before the vehicle is used for the first time or if the power supply has been interrupted, the first display will be in metric units of measurement (. . . UHR). Press changeover contact once for US (MPG) Press changeover contact twice for Imp. (M/G) Press changeover contact thrice for metric units (L/100)
Time – initial input (or after electrical repairs)	<input checked="" type="radio"/> Changeover contact (5)  <input checked="" type="radio"/> Changeover contact (5)		Before the vehicle is used for the first time, and after a break in the power supply, --- U H R appears in the display. Input the time with the display showing 0000 U H R. The clock starts to run as soon as the dot between the hours and minutes appears.
Country-specific initial time input AM/PM	 <input type="radio"/>  <input checked="" type="radio"/>   <input type="radio"/>		The display shows 1200 AM. Press the 1000 button twice to alter display from AM to PM; if the time has already been input, press AVG MPG to obtain the display in another language. Then press the changeover contact and blend in the time display by pressing the HR-DATE button. The change to AM/PM is automatic.

Function	Input: press buttons in the sequence shown below	Information display: Press button shown below for display of function desired	Notes: Programming information and display description
Date			<p>Input of the date on a new vehicle (or after electrical repairs) is only possible after the clock has been set and the display shows "0000 DATE".</p> <p>For correction of an error, follow procedures outlined under "correction (Time and Date)" below.</p> <p>The date function begins to operate when the dot appears between month and day.</p> <p>To obtain the date from a different information display, press the HR-DATE button twice. Note: The metric display only is in the sequence (day) (month).</p>
- Correction (time and date)			<p>Press the HR-DATE button for corrections only if other than the desired display is shown.</p> <p>Press the changeover contact to erase the dot (between month and day or between hours and minutes). Input the correction. Press the changeover contact to restart the function and the dot will reappear.</p>
Average speed			<p>Press buttons in sequence shown anytime to begin re-computing average speed. However, if during a trip the average speed is already displayed, it is only necessary to press SET-RES</p>
Speed limit warning			<p>If the input speed limit is exceeded, the LED flashes and a gong sounds. Press the information button again to switch off the speed limit warning: the LED will go out, but the speed value in the memory is retained. When changing to a different language/unit of measurement, the memory is erased.</p>

Function	Input: press buttons in the sequence shown below	Information display: Press button shown below for display of function desired	Notes: Programming information and display description
Average fuel consumption	<p>AVG MPG</p> <p>SET-RES</p>	<p>AVG MPG</p>	Press buttons in sequence shown anytime to begin recomputing average fuel consumption. However if during a trip the average fuel consumption is already displayed, it is only necessary to press SET-RES
Range	—	<p>RANGE</p>	A plus sign (+) before the value displayed indicates a full fuel tank and a range higher than that displayed.
Stopwatch – Start	<p>TIMER SET-RES</p>	—	Press timer button for stopwatch function. Press SET-RES to start stopwatch. When stopwatch is running, the LED lights up.
– Stop watch display	—	<p>TIMER </p>	If the stopwatch is running (LED lit) and another display is shown, press time button to display stopwatch.
– Stop	<p>TIMER SET-RES</p>	—	When other than stopwatch displayed, press buttons as shown to stop. If stopwatch displayed, press SET-RES to stop.
Ambient temperature	—	<p>TEMP</p>	When the temperature drops to 37 °F (+3 °C), a gong sounds. The temperature is automatically displayed for 8 seconds if a display other than temperature has been selected.
Anti-theft protection – to activate and immobilize car	<p>Ignition key to 1</p> <p>CODE</p> <p>1000 100 10 1</p> <p>Ignition key to 0</p>	—	Follow sequence shown and enter any "code" from 0000 to 9999. Turn ignition key to position 2 to cancel. In case of error, repeat sequence. Memorize the code number!
– to cancel	<p>Ignition key to 1 or 2</p> <p>1000 100 10 1</p> <p>Input code numbers:</p> <p>SET-RES</p> <p>or start engine</p>	—	Warning: if 3 incorrect inputs are made consecutively, or 3 attempts are made to start the engine, a horn sounds for 30 seconds.

Further information on the On-Board Computer

(Changes in information programs are only possible after pressing the relevant information button).

HR-DATE

Dual function Button. The time and date are displayed alternately by pressing the button. After initial connection to the power supply, 4 flashing segments will appear in place of the time or date display. Inputs can be made after pressing the changeover contact (5) with a ball-point pen (0000 AM/PM display).

To correct the time or date, press the changeover contact (5) until the dot (between the hour and minutes or month and day) disappears. After the correct time/date has been set, press the changeover contact (5) again to restart the clock/day counter. The dot will then reappear.

The clock can be set to an accuracy of 1 second by pressing the changeover contact (5) when a radio time signal is heard.

The date display disregards leap-years and must be corrected manually as appropriate. When changing to a different language, the time and date displays are altered accordingly.

AVG MPH

The current average speed is displayed when the button is pressed. Press SET-RES to restart the average speed calculation anytime, e.g. before starting a new trip.

M MPH

New speed limit values can be input or displayed. Press the button again to set the speed limit warning; the red LED will light up. If the input speed limit is exceeded a gong will sound and the red LED will flash.

The gong will sound again if the difference between input speed limit and actual travel speed was greater than 3.1 mph (5 km/h) at least once since the gong first sounded. To cancel the speed limit warning, press the button again; the red LED will go out. The memory is erased when changing over to a different language/unit of measurement.

AVG MPG

Current average consumption is displayed when the button is pressed. Press SET-RES to restart the average fuel consumption calculation anytime, e.g. before starting a new trip.

The On-Board Computer can be switched to a different language/unit of measurement by pressing this button and then the changeover contact.

RANGE

By pressing this button, the estimated distance which can still be covered with the fuel remaining in the tank is displayed. Below a range of 15 km (9.3 miles), a flashing four-segment display indicates that more fuel is urgently required.

The On-Board Computer only registers the addition of fuel in ignition key positions 1 and 0, and when at least 5 litres (8.8 pints) of fuel are added.

A plus sign (+) before the display indicates that the car has a greater range than that indicated, as a result of "overfilling" the tank.

TIMER

The stopwatch is started and stopped by pressing the SET-RES button. The red LED lights up to show that the stopwatch is running. Travel, standstill and parked times are all measured. The display shows either the running time or the time at which the stopwatch was last stopped.

The maximum time which can be measured is 99 hours 59 minutes. The time display shows seconds and tenths of a second for the first minute, then minutes and seconds, and hours and minutes after the first hour.

TEMP.

At ignition key position 1 and beyond, the outside (ambient) temperature is displayed when the button is pressed. At a temperature below 37 °F (+3 °C), a warning gong sounds. At the same time, the temperature function is selected automatically; the temperature is displayed and the ambient temperature flashes for 8 seconds.

The warning gong sounds again if the temperature has increased to 43 °F (+6 °C) at least once since the last warning signal, and **again** dropped below 37 °F (+3 °C).

Warning: The outside temperature display is not an indicator for possible ice on the road. Ice can form or remain even at temperatures above freezing.

CODE

When the code function is selected at ignition position 1, 4 segments flash in the display. A code number between 0000 and 9999 can now be input. Turn the ignition key to 2 to cancel the code. Turn the key to 0 to store the code number in the memory and activate the system; when an attempt is now made to start, the starter motor will turn but the engine will not start.

Memorize the code number!

To start the car or cancel the code, turn ignition key to position 1 or 2. The display will show code and 4 flashing segments. Input the code. The correct code will be automatically cancelled by starting the engine **or** pressing the SET-RES button. (Note: If **neither** of these two steps are

performed, the code will be retained in the memory for anti-theft protection).

Warning: If 3 incorrect codes are input consecutively, or 3 unsuccessful attempts are made to start the engine, a horn will sound for 30 seconds.

SET-RES

Press the button to SET-RESET:

- Average speed calculation
 - Average fuel consumption calculation;
- press to START/STOP:
- Stopwatch

If a code has been input to immobilize the car, the actual time will appear when the correct code number is input and the SET-RES button pressed.

**Ski bag**

Up to 3 or possibly 4 pairs of skis can be carried safely and cleanly in the ski bag.

The ski bag itself is 4 ft (1.20 m) long. Using the space available in the car's trunk skis measuring up to 7 ft (2.10 m) can be carried. If several skis are inserted, the narrower front section of the ski bag reduces the available space, so that only 2 pairs of 7 ft (2.10 m) skis can be carried together.

Loading the ski bag

Fold down the center armrest and detach the cover panel at the top; it has a VELCRO® fastener.

Press the two locking levers together and at the same time lift out the center armrest. This will expose the full opening for the ski bag.

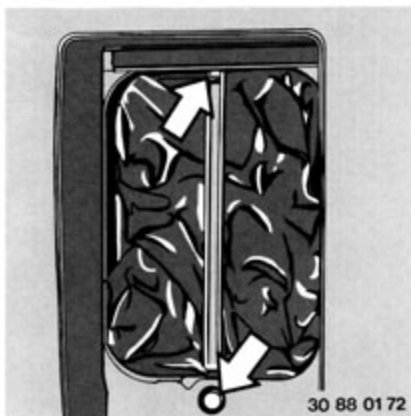

30 88 0172

To release the loading flap in the trunk press the round knob. Then detach the retaining loop at the upper hook and swing it down.

Lay the ski bag out between the front seats. If the ski bag is not used for a lengthy period, store in a dry place.

The ski bag does not need to be impregnated with any of the protective products available from the trade.

However, it is advisable to remove water caused by melting ice or moisture condensation from the ski bag at intervals after use, since the bag is waterproof and this water cannot otherwise escape.

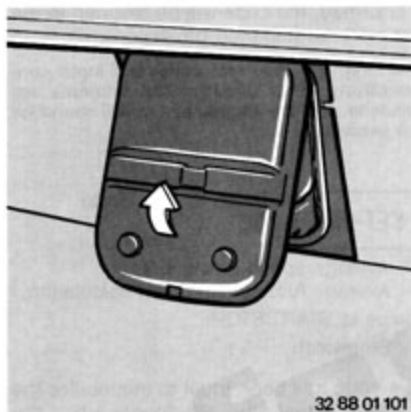

32 88 01101

If the ski bag is not needed in the car, the opening in the trunk can be sealed with a cover (available as an accessory), which is inserted from the trunk side and retained by reusable spreader clips.

Working from the trunk, secure the loading flap to the underside of the rear window shelf with the magnetic retainer.

Make sure that the skis are clean before they are placed in the ski bag and prevent sharp edges from damaging the bag.

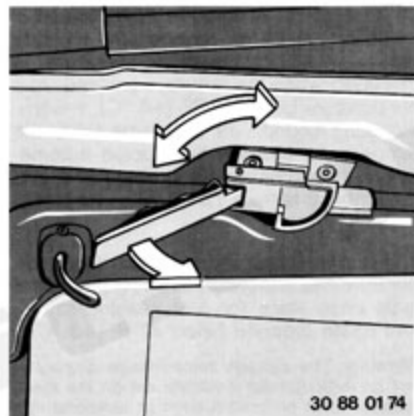

30 88 0174

Convertible soft top

To ensure that your open-car motoring pleasure is not disturbed by any unpleasant incidents, make sure that the car is protected as far as possible against intruders when parked. When closed, the soft top not only provides the necessary weather protection but also resists the entry of all but the most determined thief or vandal.

To open the soft top: The front and rear side windows should be lowered completely before the soft top is folded back.

Hold the top in the center down and turn the 2 clamping and locking levers towards the rear view mirror a full turn. After turning and releasing both levers the soft top can be raised from the windshield header.

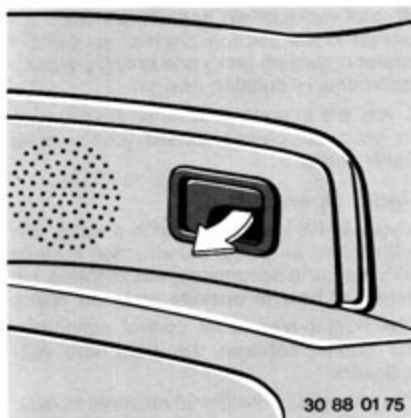

30 88 01 75

Unlock the soft top storage compartment with the handle in the left rear side panel trim.

Note: In order to open the storage compartment cover, the rear bow must be raised into a vertical position.



30 88 01 76

Next, release the safety catch and open the cover. The soft top can then be lowered. The storage compartment cover is held in position by two gas filled springdamper units when open.

The trunk lid and the storage compartment cover are mechanically interlocked to prevent damage.

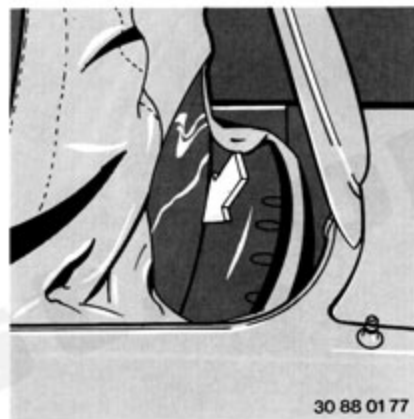

30 88 01 77

The soft top must be stored in a series of regular folds, making sure that the rear window is **neatly stowed without creases**.

The rear bow should first be lowered completely into the storage compartment. To avoid scratching the rear window, a soft cloth should be placed in the fold formed by the window.



Closing the soft top:

First lower the side windows. Release the storage compartment cover lock, open it and lift the soft top out at the side guides.

Caution: When raising the side windows, especially while driving, always raise the rear windows first to prevent any possibility of misalignment with the front door windows.

Note: If the soft top or the rear window begins to flap at high speeds, move the sliding air distribution control to the right (open) to avoid a drop in air pressure inside the car.

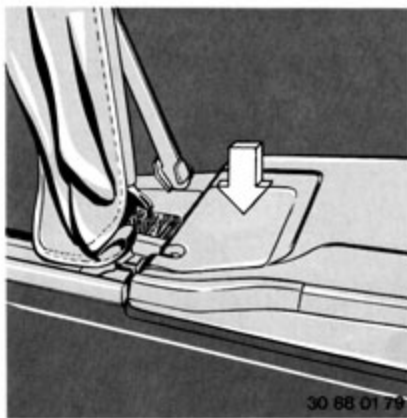

Position the rear bow vertically, and close the cover again securely by pressing down at the points indicated. (Make sure that the cover of the storage compartment is shut securely; press it down until it is heard to engage at both sides.) Next, fold the rear bow down, insert the guide pins on the windshield header and lock the soft top into position with the locking lever.

The rear bow is automatically pressed on to the cover of the storage compartment and makes a tight seal.

Note: Due to the folding nature of the soft top, a convertible will not be as tightly sealed or as free of road generated noise as a sedan. Directed streams of water, such as from hoses or car washes, can be expected to cause minor leaks, especially at joints and seals. Accordingly, care should be taken while washing to prevent water entry into the car.

No roof racks or ski holders are to be attached to the soft top. Consult your BMW dealer regarding racks and holders with attachments of suitable design.

If you are interested in other accessories for your car, please contact your nearest BMW dealer.

Radio Operation

If your BMW is equipped with a radio, you will receive an owner's instruction manual with the car's documents; this contains full details of **how to operate your car radio**.

The front-to-rear fader control distributes the sound between the front and rear speakers.

The strength of the signal received by your car radio antenna, and thus the quality of the sound emerging from the loudspeakers depend on the position of the receiver and the height and direction of the antenna. These factors are relatively easy to take into account on a home radio receiver, but for a mobile radio set such as that in a car certain concessions have to be made. The position of the receiver is constantly changing and it is impossible to keep the antenna aligned with the direction of signal transmission.

Antenna

The antenna should be cleaned regularly and protected against weather effects with antenna cleaner/lubricant.

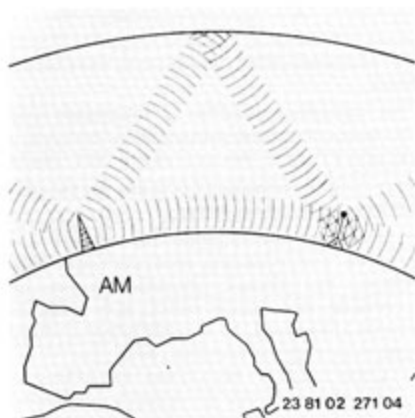

Climatic effects: fog, rain or snow can interfere with good radio reception.

As the **strength of sunlight** increases, long, medium and short wave reception is adversely affected. These wavebands can be best heard after dark, when the ionosphere reflects more of the transmitted signal back to earth.

AM provides a larger or, in some cases, exceptionally wide reception range, since the signals are not only dispersed as **ground waves**, which cling to the curvature of the earth, but also as **space waves**, which are reflected off a layer in the ionosphere and bounce back to earth.

There are physical reasons why the quality of AM reception is not as good as on FM.

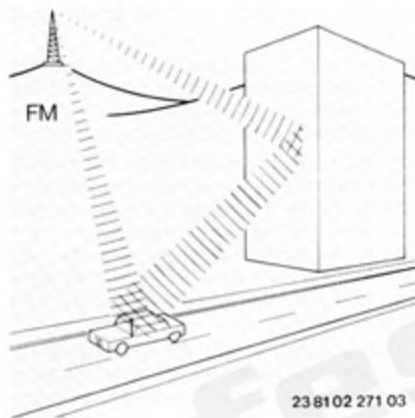

However, long distance reception is good, particularly at night, so that a large number of stations can be received, though the station density is such that mutual interference often occurs.

The **FM** transmission system offers far better sound quality than AM. However, reception is limited to only a few stations at a time, since the radio waves are emitted in a **straight line** from the transmitter tower and thus cover an area not more than about 50 miles (80 km) in radius.

As the distance from the transmitter to the receiver increases, background noise be-

comes more of a problem, and finally the station can no longer be heard and is displaced by a more powerful one which the car is approaching. These too are natural factors which can only be avoided by retuning to a stronger signal.

Stereo, if transmitted in your area, can only be received on FM. As you move away from the transmitter, interference becomes noticeable more rapidly than on mono transmissions. In this case, switch to mono reception or tune to another station giving reliable stereo reception.

Fluttering noise is caused by signal fade, when the line-of-sight link between transmitter and receiver is blocked by large buildings or geographical features. A similar effect is sometimes heard when driving along a tree-lined road.

Hissing, sizzling and splashing noises: disturbance in this category occurs when reflected signals are picked up by the car radio a fraction of a second after the main signal, for instance from large buildings nearby. The sound level also fluctuates repeatedly.

Continuous high level of background noise: this normally indicates that the edge of the transmitter's zone has been reached, or the car has been driven into a "shadow" where no direct signals are received. The only alternative is to retune to a more powerful station.

Severe fade: this is a phenomenon more often encountered on AM, and accompanied by distortion. It is caused by the superimposing of ground waves and airborne signals at the reception point.

Before and after starting

Pull parking brake

Turn off as many items of electrical equipment as possible to reduce the load on the battery, and on manual transmission cars depress the clutch pedal.

Always check first that the gear lever is in neutral before operating the starter.

Automatic transmission cars can only be started with the selector lever at **P** or **N**.

For cold starts, do not depress the accelerator pedal.

To start the engine turn the ignition key clockwise to position **3** and hold it there until the engine starts (but not longer than 20 seconds). When the key is released it will return automatically to position **2**.

The engine may run at a faster than usual idle speed while warming up.

If the starter has to be operated a second time, the ignition key must first be turned back from **2** to **1**. This interlock has been deliberately introduced to help ensure that the starter gear does not come into contact with the flywheel gear before the engine has stopped turning.

In very cold weather the first attempt to start the engine should not last too long (max. approx. 20 seconds) in order to limit battery discharge. If a second attempt is necessary, wait a short while (about 20 to 30 seconds), and then operate the starter again for a similar period.

The fuel injection engine of your BMW is equipped with automatic cold-starting and warming-up systems.

To stop the engine, turn the ignition key back to position **1**.

Reductions in exhaust emissions and fuel consumption and the quality of the fuel used all influence the running characteristics of the engine.

Varying operating conditions are largely compensated by the measuring and control functions of the car's electronic system and by the high production standards of individual components. Individual systems such as electronic ignition and fuel injection are also important in this respect.

Unusual engine and drive characteristics, for example when accelerating from a low engine speed, when combustion recommences after the overrun fuel shutoff has operated or at a low engine idle speed, are design features resulting from the compromise between demands for lower fuel consumption, ecologically more acceptable motoring and greater ride comfort, and not a sign that the vehicle needs attention.

BMW cannot be responsible for mechanical damage that could result of inadequate fuel, service or parts availability.

Emission Control System

The Emission Control System of your BMW is designed to remove pollutants of unleaded fuel only.

If leaded fuel is used – even if only for a short period – the **oxygen sensor** and **catalytic converter** will be damaged and rendered inoperative.

Have the scheduled maintenance performed to ensure undisturbed engine functions.

To fulfil EPA Emission Standards the oxygen sensor and catalytic converter must be replaced after using fuel containing lead.

The catalytic converter is integrated into the exhaust system and installed below the vehicle's floor in the area of the front seats.

After 50.000 miles or 80.000 km the oxygen sensor must be replaced.

If unburned fuel reaches the catalyst, excessive temperatures and damage may result. You should therefore avoid all operating conditions which are likely to cause unburned or insufficiently burned fuel reaching the catalyst, e. g.:

- unnecessarily prolonged operation of the starter motor or repeated cranking without the engine starting. (A fully functional engine may be stopped and started without problems).
- Tow start only with a cold engine, as otherwise unburned fuel reaches the catalyst – use starting cables.
- frequent, repeated cold-starts
- allowing the engine to run with spark plug caps disconnected.
- Never run out of fuel to avoid misfiring of engine.

If the ignition should misfire, please drive to the nearest BMW service station, using low engine speeds only.

Warning: Never leave engine idling unattended. An unattended vehicle with a running engine is potentially hazardous.

Do not park or operate the vehicle in areas where the hot exhaust system may come in contact with dry grass, or other material which can cause a fire.

Evaporative Emission Control System

This is a purge system consisting of a liquid-vapor separator charcoal canister and purge lines which prevents gasoline vapors from escaping to the atmosphere.

Break-in hints

The engine of your BMW has not been governed in any way, so that there is no restriction on its performance even when new. It is therefore up to you to ensure that the full operating life and potential economy are later achieved, and this is best done by adhering closely to the following **break-in rules**.

Caution: Engine idle speed is controlled by the engine computer system. Increased speeds at start are normal and should decrease as the engine warms up. If speed does not decrease, service is required.

For the first 1200 miles (approx. 2000 km), drive at varying road and engine speeds.

Do not exceed the following engine speeds:

BMW 325 i/iS/iX 4000 rpm

Note: Do not exceed two-thirds of the vehicle's maximum speed in 5th gear.

Do not use full throttle or the kick-down position of the accelerator pedal at all during this period.

Remember that the break-in rules apply to other mechanical assemblies such as the transmission or rear axle, and not just to the engine.

Should any such assembly be replaced at a later stage in the car's life, the break-in procedure must be repeated.

During the break-in period, a degree of **stiffness** may be noticed at the gear shift, in the steering and other controls and mechanical assemblies. This will disappear after a short period of use and should be regarded as part of the normal break-in process.

Hints on breaking-in brake pads:

As a means of achieving uniform wear patterns and a good friction coefficient on new pads, avoid repeated violent brake applications, especially from high speeds, during the first 300 miles (approx. 500 km), and also prolonged severe loads such as may occur when descending lengthy mountain passes. During the break-in period, refrain from subjecting the brakes to any form of endurance testing.

Brake pads and discs require the distance stated above and the quoted operating conditions in order to seat properly and give smooth results and maximum wear during the car's life.

Since the parking brake operates on an entirely separate brake system with its own drums, it must also be seated correctly.

If road surface, weather and traffic conditions permit, it is possible to achieve the desired effect by applying the parking brake lightly at about 25 mph (40 km/h), until definite resistance is felt. The lever should then be pulled up to the next notch and the car driven for about another 1300 ft (400 m) before the parking brake is completely released. This procedure will enable the parking brake to operate at maximum efficiency.

During the pre-delivery check or Inspection your BMW dealer will seat the parking brake linings correctly.

You can repeat the process yourself provided that due care is exercised, at three-month intervals or whenever parking brake action becomes less effective.

Break-in procedure for tires:

The production methods used in the tire industry result in brand-new tires having less than their designed adhesion at the road surface. Until full grip is available, and as a means of obtaining a good wear pattern we recommend you drive with restraint for the first 200 miles (approx. 300 km).

After 1200 miles (approx. 2000 km) have been covered, you can **gradually increase** your road speeds to the **specified cruising and top speeds** of your car, assuming that general road and traffic conditions make such speeds possible.

Note: Obey your local and state maximum speed limits.

Required fuel quality:

Your BMW is designed to operate with **unleaded fuel with an Anti-Knock Index of 87 AKI**. This designation is comparable to Research Octane Number 91 RON.

Warning: Never carry additional fuel containers in your vehicle. Such containers, full or empty, may leak, cause an explosion or result in fire in case of a collision.

Only use fuels advertised to have adequate detergency and low alcohol content. Use of fuels with insufficient detergent and/or excess alcohol can cause driveability problems that necessitate cleaning intake valves and fuel injectors.

Travelling in foreign countries

Prior to using your BMW in a foreign country, check to ascertain if fuel of the required octane level is available to avoid engine damage.

Should unleaded fuel not be available in the foreign country in which you are travelling or intend to travel be aware that the use of leaded gasoline will render the oxygen sensor and catalytic converter of your BMW inoperative. As a result, the vehicle will not meet the emission requirements of the US and Canada and maximum fuel economy will not be obtained. It will, therefore, be necessary upon your return to the US or Canada for the fuel system to be purged of the leaded fuel and both the oxygen sensor and catalytic converter to be replaced in order for the vehicle to be legally operated in the US and Canada.

Your car's **fuel economy** is mainly dependent on your style of driving. Highspeed driving, acceleration to the limit in all gears, violent cornering and sudden braking all take their toll, not only in terms of heavy fuel and oil consumption, but also faster wear of brakes, tires and all the engine parts.

After driving for a while in dense city traffic or bumper to bumper, we recommend letting your engine "**take a deep breath**" by covering the next mile or two at engine speeds of 3000 rpm. This will help eliminate any carbon build-up in the cylinders.

It is not recommended to allow the engine to warm up at idling speed. Drive away at moderate engine speeds immediately after starting. However, if the outside temperature is exceptionally low the engine should be allowed to run at increased idle speed for about half a minute, to ensure proper circulation of the engine oil. Never run a cold engine at high speeds or its useful working life will be seriously reduced.

When **declutching**, always push the clutch pedal down fully; never drive with the foot resting on the pedal.

The **brake booster** on your BMW works pneumatically, so that the necessary vacuum is provided only when the engine is running. When the car is moving with the engine off, e. g. when it is towed, greater pressure on the brake pedal is needed to reach the desired braking effect.

Caution: Do not drive with your foot resting on the brake pedal. "Riding" the brakes may result in abnormally high temperatures, lining wear and possible brake failure.

The economy of your BMW depends to a large extent on your driving style. Driving economically means watching the traffic well ahead and adapting to the conditions. Driving economically does not necessarily mean driving slowly.

Always keep the trunk lid closed when on the move. This will prevent toxic exhaust gas from being drawn back into the car's interior. If you are carrying bulky items and cannot close the lid, it is a good precaution to close all the windows including the sliding roof if equipped and run the fresh air or heater blower at medium to high speed.

Warning: Do not put packages on the flat area behind the rear seat, as they may obscure vision and may become dangerous projectiles in the event of a sudden stop.

Hang clothes in such a way that they do not impair the driver's vision.

Do not hang heavy objects on the coat hooks. They could cause personal injury in the event of a sudden stop.

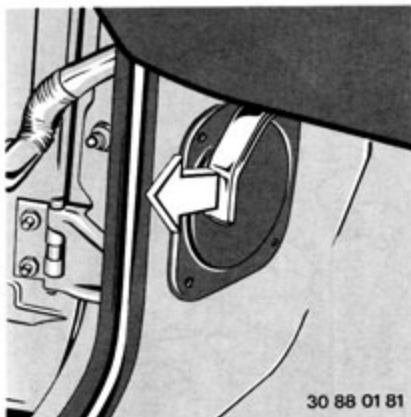

30 88 01 81

Hood

The hood is opened from inside the car by pulling the lever on the left side panel of the footwell.

Warning: Should you notice at any time while driving that the hood is not secured properly, please stop at once and close it. Before you check anything in the engine compartment, stop the engine and let it cool down. Hot components can burn skin on contact. Never touch the radiator fan blades. When there is danger of coming in contact with electric cables, when doing repair and maintenance work, especially in the engine compartment, always disconnect the battery. Several parts of the car's equipment are made of asbestos. Asbestos fibers may be present in the form of dust and could cause cancer and lung disease. Please note warnings on the marked spare parts.

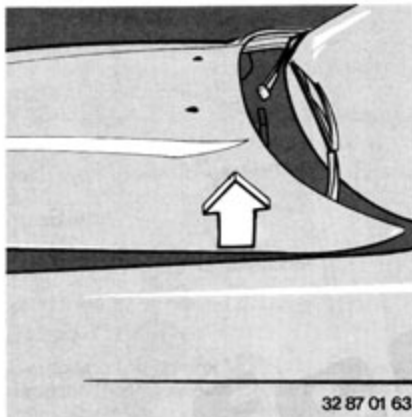

32 87 01 63

Improper handling of parts installed and materials used in the vehicle can endanger your personal safety. If you are not familiar with the pertinent safety rules, ask your BMW dealer to perform the necessary work.

Warning: Any contact with ignition components when the engine is running is highly dangerous.

A built-in mechanism makes it easy to open and raise the hood from the outside after release.

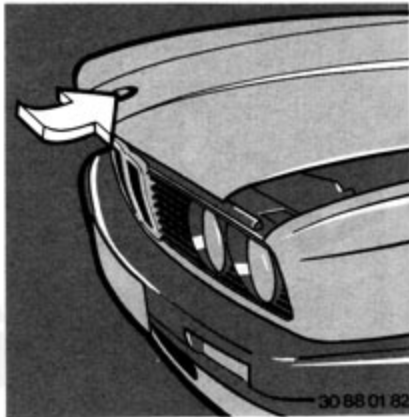

30 88 01 82

To close the hood, move it down and press slightly to the rear at the middle of the hood front section.

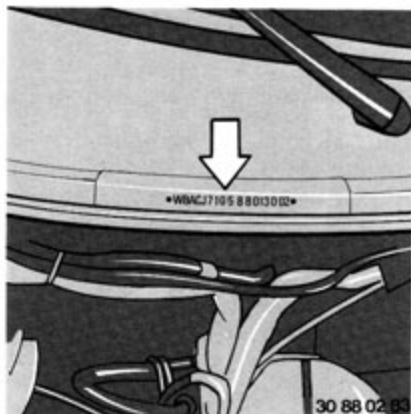

Chassis Number

The chassis number can be used to check the identity of your car against your registration and licensing certificates.

The chassis number is stamped on the right hand side of the heater bulkhead and also on an adhesive label located inside the left front door opening.

The number is also stamped on a metal strip that is fastened to the dash adjacent to the middle of the windshield.

In an effort to deter theft the number is also stamped on body components, engine and transmission.

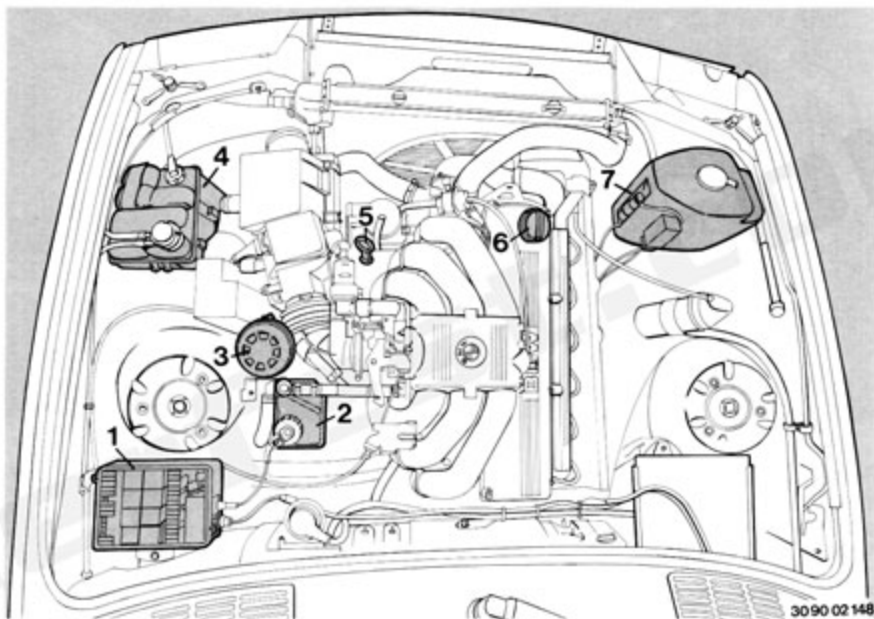

The engine compartment at a glance

- | | |
|---|--------------------------------------|
| 1 – Fuse box | 4 – Coolant tank |
| 2 – Fluid tank for brake and clutch hydraulic systems | 5 – Dipstick for engine oil |
| 3 – Fluid tank for power steering | 6 – Engine oil filler |
| | 7 – Fluid tank for windshield washer |



Engine oil consumption

Engine oil consumption, like fuel consumption, depends on the way in which the car is driven and the operating conditions.

Engine oil level check

We recommend that you check the engine oil level regularly, for instance whenever you buy fuel. If necessary, add fresh oil to the filler on the engine's rocker cover. Do not fill beyond the upper mark on the dipstick.

The most accurate oil level reading will be obtained with the car standing on a level surface and the oil cold (before the engine is started), or (if the engine has already been run) allow the oil to drain back into the sump for a short period.

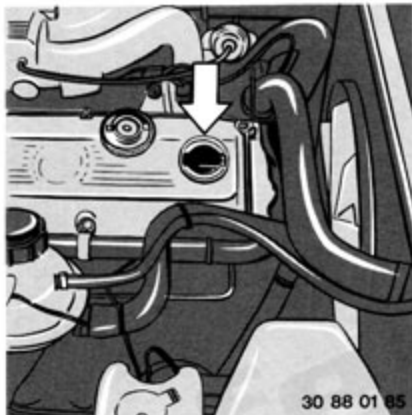

Make sure that the dipstick is inserted fully into the tube on the engine block.

Caution: For disposal of used engine oil obey local regulations or environmental rules.

We suggest you have the oil changed at your BMW dealer.

Continuous contact with used engine oil has caused cancer in laboratory tests, wash skin thoroughly with soap and water after handling.

Always keep oils, greases etc. out of reach of children! Please note precautions on containers.

Adding fresh engine oil

The quantity of oil represented by the space between the two marks on the dipstick is approx. 1.1 US quarts/1 liter.

Adding too much oil serves no useful purpose and may even harm the engine. Since this excess oil will tend to be burned off

within a short time, it may create the impression that oil consumption is heavier than usual.

The best procedure is to add fresh oil only when the level has dropped almost to the lower mark on the dipstick. However do not allow the level to fall below the minimum-level mark.

BMW engines are designed to require **no oil additives** if one of today's highly advanced brand-name lubricating oils is used: Using additives could cause engine damage. The same applies to the oil for the manual or automatic transmission, final drive and power steering.

Note: Under severe driving conditions, we strongly advise increasing the number of oil services.

Engine oil specifications

Although API SE grade oils are approved for use in your BMW, API SF grades are **highly recommended** due to their increased oxidation stability, wear protection, and detergent properties. The increased level of protection available by the use of SF grade oil will help you to attain the maximum amount of engine service engineered into your BMW.

The chart indicates the SAE grades to be used depending on the predominant air temperature.

The temperature set by the SAE grades may remain under or exceed the limit for a short period.

Heavy duty engine oil may be used in the manual transmission if the car is driven in extremely cold climates. Contact your BMW dealer for details.

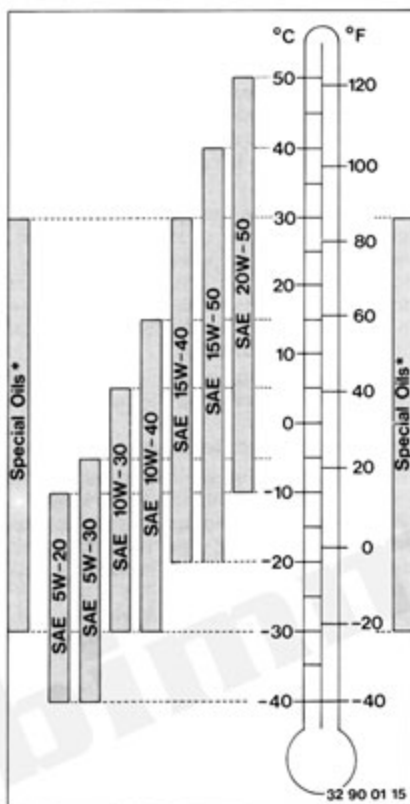

* Special engine oils individually approved by BMW (low friction lubricants). Contact your BMW dealer for details.



Power steering fluid level check

Check fluid (ATF) level in the power steering with the engine stopped, unscrew cover of fluid reservoir. Place cover onto reservoir, then take off cover. Fluid level should be between the two dipstick marks. Add fluid if necessary.

After this, **run the engine** and top up the fluid level if necessary, until between the marks.

When the engine is stopped the fluid level may rise approx. 0.2 in. or 5 mm above the "MAX" mark.

Steering stiff to turn towards right and left lock, whining noise audible:

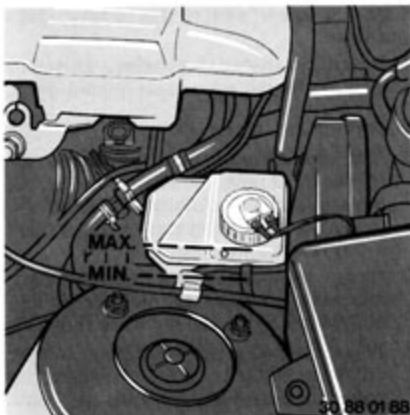

Too little fluid in system. Check level and if necessary inspect the power steering circuit for leaks or damage.

Loose V-belt. Adjust to correct tension. If belt is damaged, replace it.

A slightly higher effort is needed to turn the steering wheel when the power steering is defective.

Brake and clutch hydraulic fluid level check

The fluid is hygroscopic by nature, that means it will tend to absorb moisture from the atmosphere over time. In order to ensure that the brake system remains fully operational, **the brake and clutch hydraulic fluid must be replaced once a year.**

Top up to the "MAX" mark.

Use only DOT 4 brake fluid.

Caution: Brake fluid is poisonous. Brake fluid is also harmful to the paint of your vehicle.

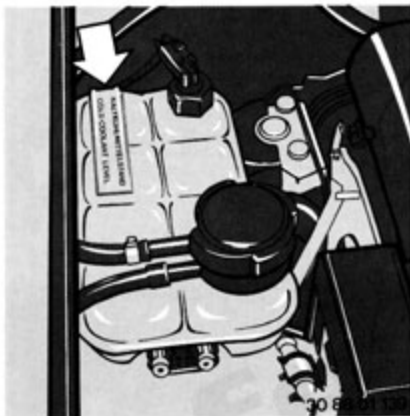

Coolant level check

The **transparent coolant tank** permits coolant level to be checked without removing the cap.

The cooling system holds approx. 11.0 US quarts (10.5 l).

Warning: Open the radiator cap only when the engine has cooled down and the coolant needle is on the lower third of the scale, or else hot water or steam may escape and scald you.

Turn the cap slightly counterclockwise to allow excess pressure to escape, then remove completely.

Overfilling will dilute the additives in the coolant, which will escape through the overflow pipe and no longer possess the correct antifreeze and corrosion inhibitor concentration.

Never add water if the cooling system is still hot and coolant has been lost: allow the engine to cool down.

Apart from regular checks on coolant level, antifreeze concentration (at least 50% = $-35^{\circ}\text{F} = -37^{\circ}\text{C}$ year round) and the condition of hoses and hose clamps, we recommend that the cooling system be drained and refilled **every two years**. At the same time, check that the filler cap seals properly and that the pressure relief and vacuum equalizing valves are in good working condition.

The fluid of the cooling system needs no further additives. Use only factory approved fluid nitrite and amino free to prevent damage.

Increasing the anti-freeze in the coolant further is not only uneconomical, it is also detrimental to engine cooling.

Anti-freeze other than specified by BMW for aluminium radiators may cause corrosion of the cooling system, leading to engine overheating and damage.

Caution: Anti-freeze is poisonous! Store in original fluid container only and always keep out of reach of children.



Windshield washer system reservoir

The fluid tank holds approx. 3.2 US quarts/3 liters.

Caution: Do not run the automatic washer if the fluid tank is empty.

In cold weather, the washer systems can be kept fully operational by adding antifreeze recommended by your BMW dealer.

Windshield washer jets

If the stream of water fails to strike the center of the area covered by the wiper on that side, the jet can be carefully repositioned with a fine needle to redirect the water stream.



Battery

Your BMW's battery is maintenance free and the electrolyte added initially should normally last for the life of the battery. If the level is too low in any of the cells, for instance after spending long periods in a hot climate, top up with distilled water (not acid).

The battery is placed behind the lining at the right hand side in the trunk.

The battery of the convertible car is located in the engine compartment on the right.

Take off the cover and unscrew the 6 cell plugs. The electrolyte level should be about 0.2 in. or 5 mm above the upper edges of the plates or at the mark visible in the filler opening, depending on battery type.

Keep the upper part of the battery clean and dry.

To remove or install the battery, loosen or tighten the toggle screw and retaining bar.

Important notes:

1. Acid or lead oxide from the battery terminals must never be allowed to contact the eyes, skin or clothing. Rinse off immediately with clean water, and consult a physician if necessary.
2. Never short-circuit the battery posts; this will cause severe overheating and could lead to the battery case bursting.
3. When the cell plugs have been removed, never bring an open flame near the battery or cause any sparks in the vicinity. This could lead to an explosion.
4. Never detach the battery leads when the engine is running, or else an overvoltage will occur and damage the car's electronic equipment beyond repair.
5. To recharge the battery without removing it from the car, the engine must be stopped and both battery leads disconnected. Connect the positive cable to the post in the engine compartment. Use the lifting bracket of the engine for negative connection. Never charge a frozen battery. It may explode because of gas trapped in the ice. Allow a frozen battery to thaw out first.
6. Disconnect the negative lead from the battery before attempting any work on the car's electrical system, to avoid the risk of a short-circuit.

7. If the vehicle is to be laid up out of use longer than 6 weeks – see page 64 – remove the battery, have it charged and stored in a cool place with no risk of freezing. The battery must be recharged after not more than 3 months or it will discharge completely and cannot then be re-used on the vehicle.
8. To remove the battery, first disconnect the negative lead, then the positive lead. Unscrew the battery retaining bar. When installing, first secure the battery with the retaining bar, then connect the positive lead and finally the negative lead.

Fuses

If any electrical equipment on your car should fail, first check the fuses.

The fuse box with spare fuses, fuse removal tool and relays is located on the left wheel arch inside the engine compartment.

A blown fuse can be identified by the melted metal strip inside the fuse holders. Pull the blown fuse out with the fuse removal tool (arrow), trace and rectify the cause of the failure, then insert a new fuse of the correct rating.

In case of recurrence of a blown fuse contact your authorized BMW dealer to perform the necessary work.

Placards, located on the inside of the fuse box lid will help you to find the appropriate fuse and the correct ampere rating.

Caution: Never replace blown fuses with wire or attempt to repair them in any way (fire hazard).

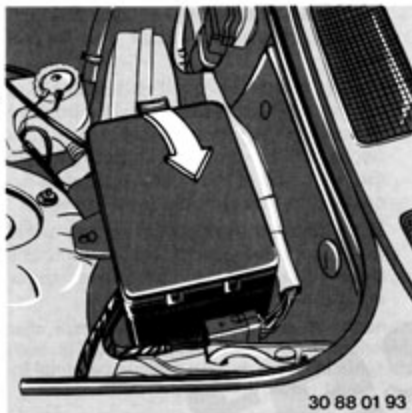

Ratings in Amperes, equipment supplied.

- | | | | |
|------------|---|------------|---|
| 1 = 7.5 A | Left high beam | 13 = 7.5 A | Left low beam |
| 2 = 7.5 A | Right high beam | 14 = 7.5 A | Right low beam |
| 3 = 15 A | Auxiliary fan 196° F (91° C) | 15 = | Vacant |
| 4 = 15 A | Turn signal, clock light | 16 = | Vacant |
| 5 = 30 A | Windshield wiper and washer | 17 = 30 | Power sliding roof, windows |
| 6 = 7.5 A | Brake lights, Cruise Control, map reading light | 18 = 30 A | Auxiliary fan 210° F (99° C) |
| 7 = 15 A | Horn | 19 = 7.5 A | Power outside mirrors, mirror heating |
| 8 = 30 A | Rear window defroster | 20 = 30 A | Blower, air conditioner |
| 9 = 15 A | Diagnostic plug, speed-range indicator for automatic transmission | 21 = 7.5 A | Interior lights, radio memory, instrument panel lights, glove box, rechargeable flashlight, clock, trunk light, fasten seat belt gong, ignition key warning gong, |
| 10 = 7.5 A | Instruments, backup light, Check Control | 22 = 7.5 A | Left rear light, front position light left, front side marker left |
| 11 = 7.5 A | Main and aux. fuel pumps | 23 = 7.5 A | Right rear light, front position light right, rear side marker, license plate lights, |
| 12 = 7.5 A | Radio, booster, instruments | 24 = 15 A | Hazard warning flashers |
| | | 25 = | Vacant |
| | | 26 = | Vacant |
| | | 27 = 30 A | Central locking system, door lock heating, anti-theft protection, On-Board Computer |
| | | 28 = 30 A | Lighter, power antenna |
| | | 29 = 7.5 A | Left fog light |
| | | 30 = 7.5 A | Right fog light |

An accessory connector is located in the engine compartment close to the fuse box.

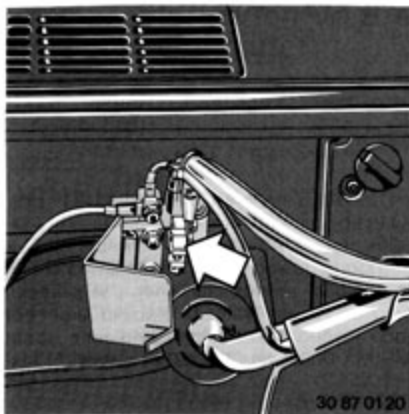

Jump starting

If the battery is run down, the engine can still be started by running 'jumper' cables to the battery from a second vehicle.

1. Check that the other vehicle has a 12-volt electrical system and a battery of approximately the same capacity in A/h.

Warning: The use of booster batteries with more than 12 volts may cause immediate and irreparable damage to the electronic components of your vehicle. The capacity (Ah) of the booster battery should not be lower than that of the discharged battery. Use of batteries of different voltage or substantially different Ah rating may cause an explosion and personal injury.

2. The dead battery has to remain connected.

3. Do not allow the two vehicles to touch another, or a short circuit may be the result.
4. First connect the positive terminals of the car's batteries together. The positive terminal of the jumper cable can be connected in the engine compartment on the right side of the heater bulkhead except on the convertible (see above). Then connect the second jumper cable to the negative post of the second car's battery and to the lifting bracket or engine block of your car.

Warning: If connections deviate from that described in the foregoing, damage to both charging systems or even serious personal injury could result.

5. Run the other car's engine at a steady 2000 rpm and then start your engine in the usual manner.

Before disconnecting the jumper cables make certain that the engine is at idle speed, switch on headlight, blower and rear window defroster to avoid damage to car's electrical system. Carefully disconnect the jumper cables, starting with the negative terminal.

Warning: The Ignition system is a high-performance system and any contact with live components when the engine is running could lead to a fatal electric shock.

When attempting any repair or checking procedure make sure there is no loose or hanging clothing and avoid contacting the electrical system or rotating fans and belts.

Tool kit

The tool kit is in a rack under the trunk lid which swings down when the retaining screw is loosened.

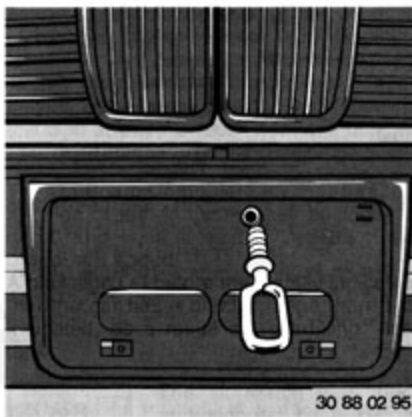

Towing

If the vehicle has to be towed away, turn the ignition key to position 1 so that the brake lights and turn indicators operate and the horn and wipers can be used.

Switch on the hazard warning flashers if required by law.

If the electrical system is out of action, the towed car must be identified (for instance by a notice or by placing the warning triangle in the rear window) so that following vehicles are warned.

In case of engine failure and when the car is being towed, the power assistance for the brakes, and steering where applicable, is no longer effective. Increased effort will be required to operate the affected systems.

If you wish to assist another driver by towing his vehicle with your BMW, make sure that the broken-down vehicle's weight does not exceed that of your own car.

PLEASE COMPLY WITH APPLICABLE STATE TOWING LAWS

Towing away – BMW automatic models

If the car has to be towed away, the ignition switch must be put to position 1 and the selector lever must be at **N** = neutral.

Towing speed should not exceed 30 mph or 50 km/h and the towing distance should be limited to 25 – 30 miles or 40 – 50 km. To tow an automatic transmission car more than 30 miles or 50 km add 1.05 US quarts/1 liter of ATF (automatic transmission fluid) to the contents of the transmission, or remove the drive shaft. After the car has been repaired, do not forget to reduce the fluid level in the transmission to normal.

Do not tow a car to start it. Also the design of the automatic transmission makes it **impossible** to start the engine by pushing or towing the car.

Emergency towing

If your vehicle gets stuck towing eyes are provided at the right back side and at the front side behind the number plate.

The front towing eye is of a screw on type and is stored in the tool kit.

Warning: Only use towing eye when it is fully tightened.

Use nylon tow ropes or straps which are sufficiently resilient to protect both vehicles against sudden jerking. Alternatively, a towbar may be used.

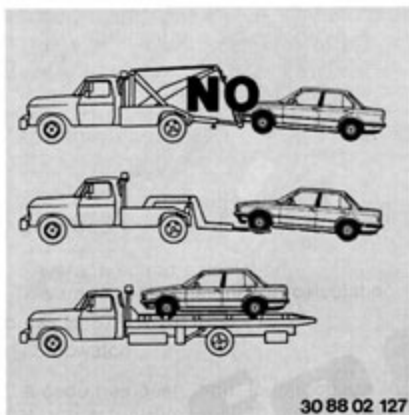

When using a towbar, both cars' towing eyes must be on the same side.

Note: Installation of certain front spoilers may prevent access to the front towing eyes. DO NOT TOW WITH SLING-TYPE EQUIPMENT. USE WHEEL LIFT OR FLAT BED EQUIPMENT.

Warning: Never allow passengers to ride in a towed vehicle for any reason.

BMW 325 iX

Do not tow the vehicle with one axle clear of the ground as this would damage the viscous coupling between the front and rear final drives. If there is no alternative to tow the car in this manner, remove the driveshaft to the axle which is in contact with the road.

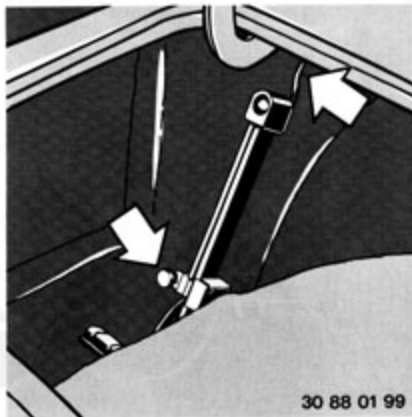

Wheel changing

Flat tires are fortunately a rare event nowadays. Should you have the misfortune to suffer a puncture, drive the car away from the main traffic stream and apply the parking brake. Comply with local regulations concerning the protection of broken-down vehicles by switching on the hazard warning flashers and setting up a warning triangle, flashing signal lamp etc. at a sufficient distance away from the car.

The **spare tire** is located in a recess under the carpet of the trunk floor.

Jack and wheel stud wrench

The jack and wheel stud wrench are housed in a compartment on the left side of the trunk. The jack can be lifted out after removing the wing nut. To prevent noise

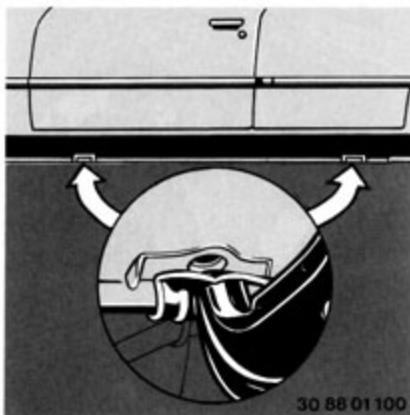

30 88 01 100

when the jack is stored in the trunk again, it must be retracted fully and secured with the wing nut in its original position.

Caution: Place the wheel chock on the opposite rear wheel to prevent the car from moving when it is raised on the jack (this is necessary on account of the parking brake design). Set the parking brake. Pull off the hub cap. Loosen the wheel studs before lifting the car.

Attach the jack to one of the **four pickup points** provided on the body (the one nearest the punctured tire) and jack up the car until the wheel is well clear of the ground.

Warning: Never work underneath a jacked-up vehicle. Use the jack only for changing a wheel. Never use the jack to lift other vehicles or other loads as this may lead to accidents and personal injury.



30 88 01 101

Unscrew the wheel studs and change the wheels. To fit the spare wheel, insert the centering pin into one of the holes, put the wheel on to the pin, screw in one wheel stud, then remove the centering pin. Screw in the remaining wheel studs and tighten them uniformly.

Lower the car with the jack, tighten the wheel studs finally in a crosswise pattern (first one stud, then the other on the opposite side of the hub) and have the tightening **torques** checked at the earliest opportunity. (110 Nm/81 ft/lb with a calibrated torque wrench.) If a new tire (or the spare tire) is installed for the first time, have tightening torques of studs checked after approx. 600 miles (1000 km).

Have the flat tire repaired and rebalanced as soon as possible.

Tire repairs should always be entrusted to a BMW dealer or a specialist tire dealer



30 90 02 274

capable of examining the tire to determine the full extent of possibly concealed damage.

Warning: When removing or replacing tubeless tires, the rubber valve must also be replaced as a safety precaution.

Light alloy wheel in cross-spoke style:

Unscrew the wheel bolt cover (which has the shape of a great hexagon nut) with the help of the wheel stud wrench and the hexagon cap (situated in the trunk) by turning it counterclockwise.

Attach the jack to one of the **four pickup points** provided on the body (the one nearest the punctured tire) and jack up the car until the wheel is well clear of the ground.

Warning: Never work underneath a jacked-up vehicle. Use the jack only for changing a wheel. Never use the jack to lift other vehicles or other loads as this may lead to accidents and personal injury.

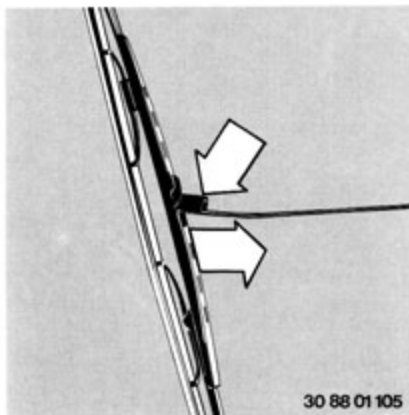

Wiper blades

To remove a **wiper blade**, swing the arm away from the windshield. Press the retaining spring and pull the blade from the arm.

Note: Do not manually move the wiper arms across the windshield because you may damage the wiper arms or pivots.

The complete wiper arm can be pulled off after folding up the plastic cap and loosening the retaining nut.

Always loosen wiper blades frozen to the glass before operating the wipers to prevent damage to the wiper system.

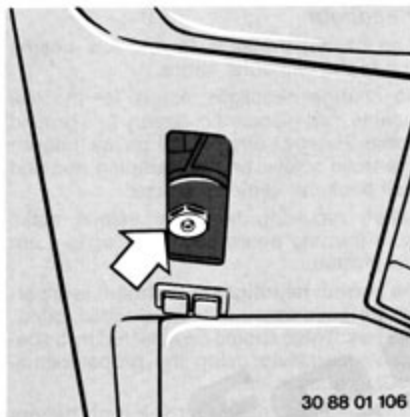

Sunroof

If the electric motor drive of the **sunroof** should fail, the sunroof can be operated manually as follows.

(Using tools supplied in the trunk lid.)

- Remove protection cap.
- Loosen nut with spark plug wrench and adjust sunroof with an allen key to desired position.

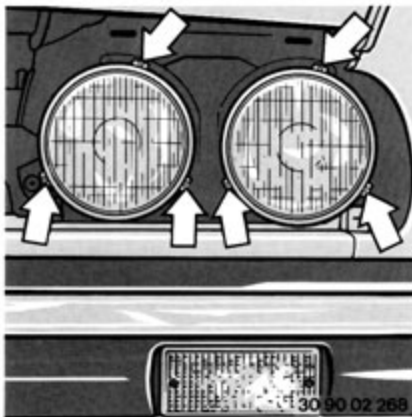

Bulb changing

When **changing bulbs** or performing any other minor jobs on the electrical system, avoid short circuits by leaving the item concerned switched off or disconnecting the negative lead at the battery.

When replacing bulbs always use a clean cloth to keep the glass free of contamination.

Caution: The halogen headlamp bulb contains gas under pressure. The bulb may shatter if the glass envelope is scratched or the bulb is dropped.

Headlight

The headlight inserts for the **low beams** are in the two outer lamps.

To change headlight inserts for the low beams, first disconnect battery (-) ground cable. Remove ornamental grilles. Loosen the three screws on the clamping ring and pull back the cable connector.

When replacing headlight inserts make sure that the beam alignment screws are not twisted.

As correct headlight adjustment is of particular importance in view of traffic safety, the headlights should be adjusted by a specialist workshop using the proper beam-setting equipment.

The headlight inserts for the **high beams** – i. e. the inner lamps – must be replaced in the same way.

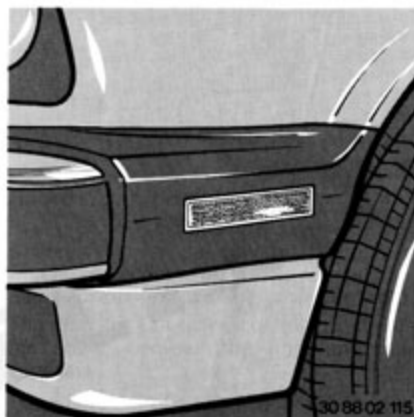

Front side marker

A front side marker light is installed on both sides of your car. The side marker lights are equipped with 4 Watt bulbs. To replace remove plastic lenses.

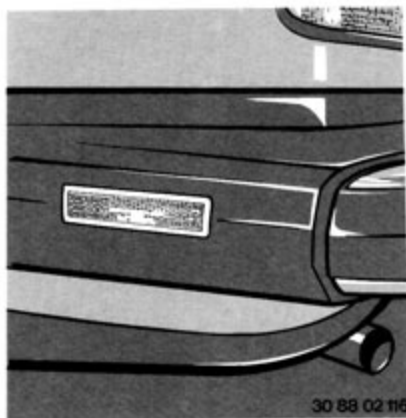

Rear side marker

A rear side marker light is installed on both sides of your car. The side marker lights are equipped with 4 Watt bulbs. To replace remove plastic lenses.

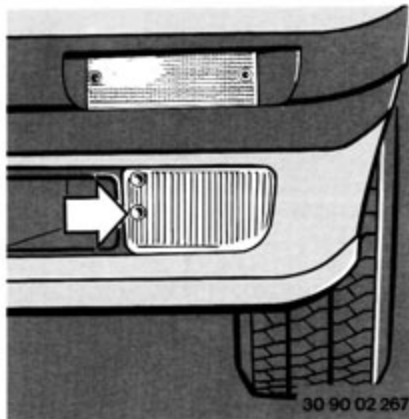

Parking light and front turning lamp

The parking light and front turning lamp are housed in the plastic lenses. Unscrew the Philips head screws holding the plastic lenses, and remove lenses. The 21/5 W spherical bulb must be pressed in slightly and turned to remove.

Replace the bulb.

Fog light

To renew the H3, 55 Watt bulb unscrew the unit and remove it.

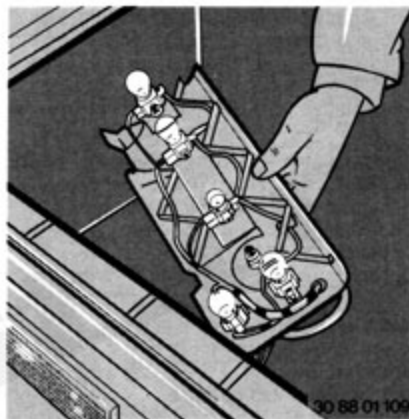

Rear light

Open the trunk, remove the rear lining panel and lift off the lens assembly. Remove the defective bulb from its holder and insert a new bulb.

Turn indicator – 21 Watt bulb.

Rear light – 5 Watt bulb.

Brake (stop) light – 21 Watt bulb.

Reversing (backup) light – 21 Watt bulb.

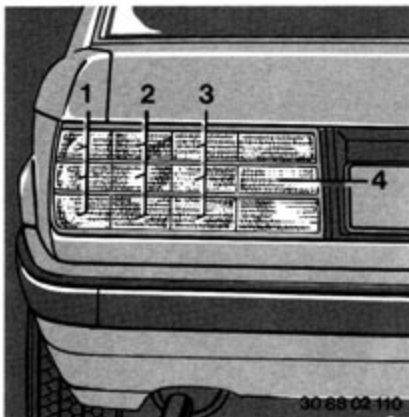

Rear lights

They are arranged as follows:

- | | |
|------------------------------|----------|
| 1 – Flashing turn indicator | (yellow) |
| 2 – Rear light and reflector | (red) |
| 3 – Brake (stop) light | (red) |
| 4 – Backup light (Reversing) | (white) |

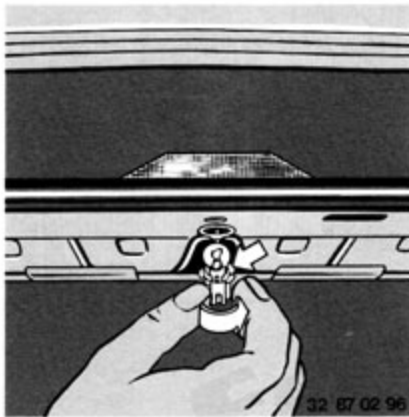

High-Mount brake (stop) light

To change the 21 Watt bulb, open the trunk and turn the lamp holder in the recess below the rearshelf counterclockwise.

When replacing the lamp holder make sure the big guide lever (upper arrow) is facing to the right.

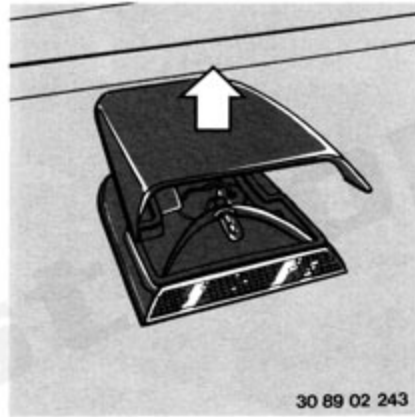

High-Mount brake (stop) light on convertibles

To change the 21 Watt bulb, open the trunk and remove the four Phillips head screws. The cover of the assembly is detachable. Replace the 21 Watt bulb.

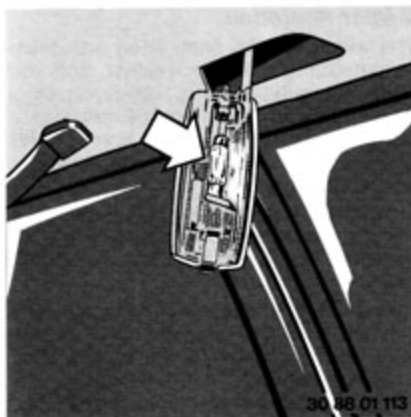

30 88 01 113

Interior light

After pulling out the interior light assembly the 10 Watt tubular-type bulb becomes accessible.

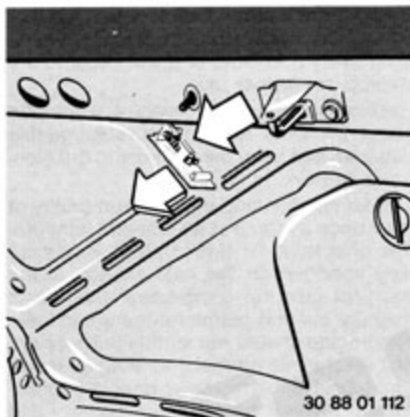

30 88 01 112

Trunk light

The 5 Watt tubular-type bulb can be reached after pulling out the luggage compartment light assembly.

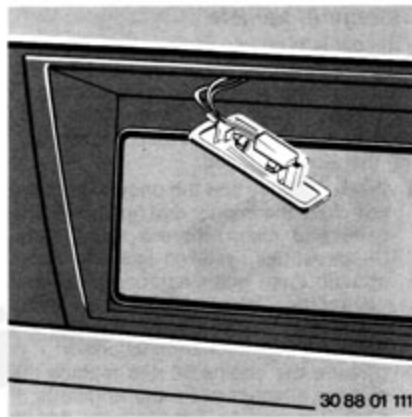

30 88 01 111

License plate light

Remove the two Phillips head screws and take off the lens frame with rubber seal. The contact blades for the 5 Watt tubular-type bulb must make good spring contact and the metal surfaces must be clean. If necessary, clean and bend in the contact blades.

Storage of vehicle

If the car is to be laid up out of use for more than three months, we recommend that the following maintenance work be performed by a BMW dealer or at any qualified workshop in order to prevent deterioration during the storage period.

1. Wash the body and the underside of the car, clean the interior and finally wax the paint and clean chrome-plated parts. Clean rubber seals on lids and doors and rub them with talcum or glycerin. If necessary, have the undercoating checked or repaired in accordance with BMW factory recommendations.
2. Change the engine oil and replace the oil filter element while the engine is at normal operating temperature. As an additional anti-corrosion measure, a corrosion inhibitor can be added to the engine oil as specified by the supplier.
3. Check coolant level and concentration, and top up if necessary.
4. Check acid level in battery cells and top up with distilled water if necessary.
5. Drain the windshield washer fluid tank and lines.
6. The fuel tank should be filled, to prevent corrosion caused by moisture condensate.
7. Increase tire pressures to 60 lb/in² or 4 bars.

Immediately before the car is taken out of use, while driving apply the foot brake and the parking brake until warm, so that the pads and linings are dry and the brake discs and drums will not corrode.

Store the car in a dry, well-ventilated space. Engage reverse gear. Do not apply the parking brake. If necessary, chock a wheel to prevent rolling.

Remove the battery and store in a warmer place. The battery must be recharged at least every 3 months or it will become unsuitable for further use.

Reconnect the battery every 4 weeks for about 24 hours to load the rechargeable batteries and keep the memory in the electronic in working order.

The air conditioning must be run briefly at least once a month at an ambient temperature of at least 41° F (5° C) (this is particularly important in the cold season of the year), or else the compressor shaft seals may dry out and permit refrigerant to leak. The engine should run for this purpose until it reaches its normal operating temperature (coolant thermometer needle approximately midway between the two colored zones). This will avoid condensate formation and the risk of internal engine corrosion. If the car is not equipped with air conditioning, do not run the engine during the storage period.

Warning: If the engine needs to be run for the above reasons, do so only in a well ventilated space to avoid inhaling exhaust fumes.

Restoring car to use

First recharge the battery, or replace it if necessary. The following maintenance work should then be carried out.

1. Change the engine oil and the oil filter element while the engine is at normal operating temperature.
2. Refill the windshield washer fluid tank, including antifreeze if necessary.
3. Restore tire pressures to the correct values.

The Inspection I, including the Annual Check, if necessary, should be performed by a BMW dealer.

Winter operation

The winter months often bring with them severe changes in the weather, and you must not only adopt a correspondingly careful attitude to driving but also take a few precautions to ensure that your BMW comes through the winter months reliably and without breakdowns.

On winter roads, tire grip is often very poor, and the driver must remember that braking distances are much greater than usual in many situations.

Before the cold season of the year commences, you are recommended to take your car to a BMW dealer, or any other qualified service establishment for the necessary winter preparations to be carried out.

Note in addition the **engine oil specifications** for winter operation.

Do not wait until the next routine oil change to fill the engine with winter grade oil if the weather turns cold suddenly.

Apart from checking oil levels during a BMW Inspection, no special winter operating precautions are needed on the manual/automatic transmission, power steering or hydraulic brake system.

The coolant on your BMW already contains a **long-term antifreeze and corrosion inhibitor**. The concentration must be kept at 50% all year. This will provide antifreeze protection down to approx. -37° C (-35° F).

Use only reputable brand ethylene glycol **antifreeze** with corrosion inhibitors that are nitrite and amino free and compatible with aluminium radiators.

Replace the coolant every 2 years. Check antifreeze concentration before and during the cold season. At the same time, inspect the cooling system for leaks and any coolant hoses which may have become porous or brittle.

Engine temperature is regulated by the coolant thermostat according to outside temperature and engine load. For this reason, **no radiator cover should be fitted** or the radiator grille blocked off.

The engine will only start reliably if the **battery** is fully charged. Remember, though, that a cold battery is less efficient, yet the demands made on it are more severe than in warm weather, with less driving after dark.

To prevent **rubber seals** on doors and lids from freezing, treat them with a rubber-care product or silicone spray.

The car's **paint**, as well as **chrome plating of polished metal parts**, should be protected before and during the winter months with suitable bodywork care products.

Have your BMW's brakes checked as a precaution before and after each winter driving period. This work can usually be combined with whatever maintenance routine happens to fall due.

Winter tires

If winter tires (radial-ply tires with special winter treat pattern) are installed, they must be of the same make and tread pattern on **all four wheels** in the interests of good directional stability and steering control.

Your BMW dealer will be glad to advise you on selecting the right winter tire for the anticipated operating conditions.

The speed rating code letters indicate the maximum permissible road speeds for winter tires (subject to legal limits):

Permissible maximum speeds for winter tires:

- Q – 100 mile/h (160 km/h)
- T – 118 mile/h (190 km/h)
- H – 130 mile/h (210 km/h)

Always adhere strictly to the maximum road speeds specified for your winter tires.

When tread depth has worn to less than 4 mm (0.16 in.), tires become much less effective in winter, and should be replaced as a safety precaution.

Observe the specified **tire inflation pressures** and have the wheels balanced whenever you change a tire or wheel.

In cold weather we recommend carrying the following items in case of emergency:

- a quantity of sand for traction on ice covered slopes
- a **shovel** to extricate the car from snowdrifts
- a **plank** to act as a support for the car's jack
- a **brush and ice scraper** to clean the windows and body panels if they are covered with snow or ice.

Use only snow chains according to SAE J 1232 classification "S". The snow chains may be used on drive wheels (rear) only.

Caution: Even if your local speed limit for cars with snow chains is higher, or there is no official speed limit, do not exceed 31 mph (50 km/h).

Winter driving hints

When planning a fairly long trip in winter, allow plenty of time in case severe weather conditions and bad roads are encountered. Local papers, radio and TV, the telephone service and the automobile clubs provide a source of information on local road conditions, and whether certain mountain passes are open to traffic.

Before starting a trip, remove ice and snow from the windows, outside mirrors and light lenses. After a snow fall, remove it from the roof, engine and trunk lid to prevent it from blowing off and obscuring your vision. Clear snow from the air entry grilles for the heater/ventilating system below the windshield, so that airflow is not impeded. Before getting into the car, try to remove slush, snow and ice from your shoes to avoid the risk of slipping off the pedals. Driving when wearing ski boots is definitely not recommended, as it is then difficult to operate the pedals sensitively or to avoid touching the wrong pedal accidentally.

After starting a cold engine particularly at temperatures below +5° F (–15° C), the gear shift may be stiff and the car's suspension may not respond smoothly for the first few minutes of a trip, and other items of equipment may prove noisier in operation. This is unavoidable while the oil is still thick.

When **driving on slippery surfaces**, depress the accelerator smoothly and slowly, and shift up to a higher gear quite early to avoid the use of high engine speeds. Keep a particularly large safety margin between your car and the one in front. Select the next lower gear when conditions permit before reaching an uphill or downhill gradient.

To improve traction on icy or snow covered roads and in hilly country when the car is otherwise unladen, 110 lb (50 kg) of ballast can be carried in the trunk. Make sure that the ballast is secure and cannot slip.

If the car skids, ease back the accelerator and disengage the clutch by pressing the clutch pedal down; on automatic-transmission cars, push the selector lever to "N". Try to steer into the skid and get the car back under control in this way.

When braking on surfaces affording only poor grip, particularly on hills, always try to prevent the wheels from locking, since locked wheels cannot be steered. If the wheels lock, release the brake pedal momentarily and then depress it again. This braking principle not only enables you to bring the car to a halt on an icy surface, but may even prove sufficient to help you steer round an obstacle.

Caution: Always declutch if braking with higher pedal pressures on slippery roads or on different road frictions.

If the car is immobilized in deep snow, sand or soft ground, pack some form of material under the rear wheels to provide extra grip before the car digs itself in too far. If no other material is available, use the car's floor mats. If possible, obtain help to push the car back on to a firm surface. With a degree of skill, the car can be rocked out of the holes caused by spinning rear wheels: use a light throttle opening and select a forward gear and reverse in rapid succession, but avoid spinning the wheels, or the car will sink in deeper still. The parking brake can be applied lightly to prevent one rear wheel from spinning: remember to release it afterwards.

Snow chains are permitted on the rear (driven) wheels only. If used, fit them in good time. They increase driving safety on snow and ice, enable the car to climb hills without slipping and reduce braking distances. The driver must, however, accustom himself to the car's changed handling characteristics. Remove the snow chains as soon as possible, as on clear roads they wear out very rapidly. During a break in the journey, or when filling the tank, remove **built-up snow and ice from inside the wheel arches**, to ensure that the steering and suspension movements are not impeded.

When parking your BMW, prevent it from rolling away by selecting 1st gear or reverse as appropriate, or moving the automatic transmission selector on "P". Apply the parking brake if parked on a slope. To prevent the parking brake linings from freezing to the drums in cold weather, use the parking brake to bring the car to a standstill from a slow speed, so that the linings and drums are dried by the heat thus generated.

Useful information on disc brakes

Your BMW is equipped with power brakes to reduce the required pedal effort utilizing a brake booster servo. Should the engine stop for any reason, several brake applications with power assist are available due to a reserve designed into the system.

When the vehicle is moved with the engine stopped and the power assist reserve exhausted, for example, when towing, a higher pedal pressure will be needed to produce an equivalent braking torque.

The engine's pumping loss due to operating the engine with closed throttle and frictional loss can be utilized effectively

to brake the vehicle by selecting a lower gear up to the rpm limit of the engine. This technique is commonly referred to as "engine braking".

To assure proper seating of the brake pads to the discs to maximize braking effectiveness, it is essential to observe the break-in instructions for the braking system of a new vehicle or whenever new brake discs and/or pads are installed.

See operating instructions, break-in rules. BMW brake components, wheels and tires have been carefully selected and engineered to provide a high degree of control under severe and diverse operating conditions. It is, therefore, recommended that BMW replacement parts be used and brake components, wheels and tires not be altered to maintain the carefully balanced braking and handling characteristics designed into your vehicle.

A disc brake system offers optimum braking efficiency, smooth response, and a high load capacity. The high temperatures which occur during brake applications, e. g. on mountain passes when driving quickly, necessitate a maximum degree of cooling which is provided by the air flow generated by the peripheral speed of the brake discs and wheel design. Altering vehicle design could inhibit air flow and impair braking effectiveness.

A slight rust film may develop on any disc brake equipped vehicle parked for an extended period of time. The rust film will be substantially less or non-existent on the brake disc surface protected by the brake pads; therefore, after such periods of extended parking, the driver may notice a slight pulsation during braking. This pulsation will disappear as the brakes are used

again. Slightly heavier than normal applications during braking will accelerate the rust removal process.

Keeping disc brakes in shape

Every now and then disc brakes should be applied quite hard once or twice from high speed – providing traffic conditions allow. The high brake pressure produced in the process ensures that the brake pads and discs are kept clean.

Similarly, on long trips in poor weather conditions, especially in winter when salt has been spread on the roads, it is advisable to apply the brakes firmly from time to time. This also tests their efficiency in the prevailing conditions (take care at temperatures around freezing point). Each 'test' application allows the self-cleaning action to take place and thus ensures the brakes' readiness for operation even under the worst weather conditions.

In wet conditions or during rainfall it is advisable to apply the brakes briefly with light pedal pressure every few miles. The heat generated in this way keeps the discs and pads dry for a certain period.

Before you park the car after driving through the rain, and especially if salt has been spread on the roads, lightly brake the car to standstill so that the brake discs remain dry and cannot corrode easily.

If the brake discs already show signs of corrosion it is possible to cure the problem in its early stages by applying the brakes hard several times. Take care not to endanger other road users!

The most effective braking action is always achieved not with locked wheels, but when the wheels are still just turning, the result obtained by the **antilock brake system**.

Locking the wheels can be dangerous, as locked front wheels can no longer be steered, and locked rear wheels cause the car to slide sideways or spin.

If brake disc corrosion is advanced and the brake pads are glazed, the discs and pads should be inspected, cleaned or repaired.

The brake system of your BMW should be checked regularly before and after the winter, possibly in conjunction with the prescribed inspection work.

We recommend you consult a BMW dealer or any other qualified service and repair establishment without delay in the event of any problems occurring in the brake system.

Caution: The movement of the brake pedal must never be obstructed by a floor mat or any other object. In case one of the two brake circuits fails, increased a pedal travel is required to bring your vehicle to a full stop.

BMW 325 iX: For brake testings on a brake dynamometer please consult your BMW dealer.

Always have the brake fluid changed every year!

Never coast with the clutch pedal depressed, the shift lever in neutral, or the ignition switched off.

All you should know about tires

The factory-approved **radial-ply tires** have been chosen to suit your BMW and provide both optimum road safety and the desired level or ride comfort.

The condition of the tires and maintenance of the **specified tire pressures** are vital factors affecting tire life and also **road safety** to a very high degree.

Tire pressures

Incorrect tire pressures are a frequent cause of complaints concerning tires. Furthermore, they may seriously affect the roadholding of your BMW.

Check tire pressure at regular intervals and before starting fairly long trips, but at least every two weeks.

When increasing the load adjust the specified value.

If tire pressure are lower than specified, this will adversely affect road safety/stability by reducing lateral locating force. The increased degree of tire sidewall flexing will lead to excessive heat build-up and thus introduce an element of risk into highspeed driving. Fuel consumption will be increased by the tire's greater rolling resistance, and tread wear will be more rapid and lead to tire pre-damage. Keep in mind that a pre-damaged tire may fail much later at less load. If you notice a loss of pressure have the tire checked for leaks immediately. Do not forget to check the spare tire as well: it should be kept at approx. 0.3 bar (3–4 lb/in².) above the specified pressure for a fullyloaded vehicle.

If tire pressures are too high, ride comfort will suffer, the tire may lack grip and tread wear will again be rapid and uneven.

Tires have to withstand very severe loads at high speeds, particularly in hot weather and at the maximum weight limit for your car. Remember to increase tire pressures if loads are high, and not to exceed the **gross weight limit**.

Warning: For your own safety: check tire pressures regularly!
Incorrect tire pressures cause increased tire wear and adversely affect road holding of the vehicle, leading to loss of control and personal injury.

Tire treads – tire damage

Check the condition of the tires frequently: look for damage, stones and nails, premature wear and overall tread pattern depth.

The **tire tread** is regarded as acceptably by law in many countries if only 1 mm (0.04 in.) deep, but it is advisable to renew tires when the tread depth has worn to 3 mm (0.12 in.). Below this depth, there is a serious risk of aquaplaning at even moderately high speeds when the roads do not appear to be too wet. If the tires wear down to 0.063 in. (1.6 mm) tread depth, a **wear indicator** will become visible at the base of the tread pattern as a reminder that the legal limit of tire wear is approaching.

Always match your road speed to the condition of your tires – particularly the remaining tread depth – and to weather conditions.

Tires must never have their treads regrooved, in view of the risk of damaging the tire carcass.

Warning: Do not drive with worn tires or tires showing cuts, bruises or other damage because they may lead to sudden deflation causing loss of vehicle control and personal injury.

When driving on wet or slushy roads, a wedge of water may build up between the tires and the road. This phenomenon is known as aquaplaning or hydroplaning and may cause partial or complete loss of traction, vehicle control or stopping ability. Always reduce speed on wet roads.

Any **foreign body** (nail or similar sharp object) penetrating the tire may cause a slow leak which will be recognized by the need to correct the tire pressure more frequently. In this event the tire should be checked and either repaired or replaced as soon as possible by your BMW dealer or a specialized tire workshop.

Drive at a moderate speed over poor road surfaces and approach unavoidable obstructions, such as a curb or severe bump in the road, with care so that the **inner structure** of the tire does not suffer internal damage invisible to you.

Take care not to damage the **tire sidewalls** when parking or driving onto loading ramps, car lifts etc. Avoid overloading your BMW – especially on vacation trips. Overloading the vehicle can also exceed the tire's permitted load capacity and thus cause **premature or subsequent** damage.

Tire damage (sudden loss of pressure) can be extremely dangerous for both yourself and other road user.

Replacing tires

Only tires of the same type and construction must be fitted on all four wheels. A mixture of cross (bias)-ply and radial-ply tires should not be used as it will alter the vehicle's handling properties.

Furthermore, all tires should be of the same make and tread pattern, in order to maintain the good ride, function of ABS and handling properties of your BMW.

BMW does not approve of the use of remolded or retreaded tires owing to the possibility of differences in the carcasses and their sometimes very advanced signs of aging, which can have a detrimental effect on their durability and, under certain circumstances, the car's handling and safety.

Tire tread wear on the front wheels tends (for design reasons) to be slightly more rapid on the outer shoulders of the tire, whereas on the rear wheels it is concentrated more on the inner shoulders and the center of the tread. For this reason, the best and most consistent roadholding and grip are obtained if the tires are **not interchanged** between the front and rear wheels, although overall tire life may then be slightly reduced.

On the other hand, we recommend that front and rear wheel alignment be checked once a year and whenever new tires are installed. Any exceptional rates on tire wear imply that wheel alignment is incorrect; this should be checked and repaired.

If, as a means of prolonging tire life, you wish to have the wheels rotated please bear the following in mind:

Due to the design principles of the front and rear axles and taking into account load and operating conditions, the front tires reach their wear limit first on the shoulders and the rear tires in the center of the tread. The higher the stresses (load, acceleration, lateral forces) the more wear will take place.

Before undertaking any change to the tires on your car, please consult a BMW dealer concerning the practical value, legal position and factory recommendations.

We recommend the exclusive use of BMW-approved tires.

Cars which are capable of a maximum speed in excess of 135 mile/h (220 km/h) must use certain tire makes and sizes. Ask your BMW dealer for details.

Obey your local regulations.

A knowledge of tire and rim markings will help you make the right choice of tire.

The speed rating code letters indicate the maximum permissible road speeds for summer tires (subject to legal limits):

S = up to 110 mile/h (180 km/h)
 T = up to 119 mile/h (190 km/h)
 H = up to 130 mile/h (210 km/h)
 V = up to 149 mile/h (240 km/h)
 VR = over 130 mile/h (210 km/h)
 ZR = over 149 mile/h (240 km/h)

The tire valves are provided with **screw dust caps** to keep out dirt. If dirt enters the valve, a slow leak may result.

Caution: When replacing or changing tubeless tires, always replace the rubber valve as safety precaution.

Improper treatment can endanger your personal safety. If you are not familiar with the pertinent safety rules, ask your BMW dealer to perform the necessary work.

Changing the wheels from front to rear on the same side can have in certain conditions only a negligible effect on the service life whereas the handling and braking as well as the roadholding may adversely affected.

If desired the spare wheel can also be put into use. In this case one must remember that this wheel, possibly new, must be broken in and will not have at first the same degree of adhesion. Rotating the wheels must be done on the same side and at short intervals (approx. 3,000 miles [max. 5000 km]). During the following period a difference in roadholding and straight driving (possibly brake pulling to one side, smaller contact surface of rear wheels on the road) must be allowed for.

In the interests of your safety and optimum driving conditions we recommend that the wheels not be rotated, because the increase in service life is negligible. With non-standard wheels and tires the wheels should definitely not be rotated.

Before undertaking any **technical modifications** to your car, please consult a BMW dealer (quoting the chassis number) concerning the practical value, legal position and factory attitude to such modifications.

The following BMW wheels and tire sizes are approved:

Radial-ply tubeless tires	Pressed-steel wheels	Cast light alloy wheels
BMW 325 i, 325 is / Convertible		
195/65 VR 14	5 ¹ / ₂ J x 14 H 2	6 J x 14 H 2
195/65 R 14 89 Q M+S	5 ¹ / ₂ J x 14 H 2	6 J x 14 H 2
195/65 VR 14		6 ¹ / ₂ J x 14 H 2
195/65 R 14 89 Q M+S		6 ¹ / ₂ J x 14 H 2
BMW 325 iX		
205/55 VR 15		7 J x 15 H 2
205/55 R 15 87 Q M+S		7 J x 15 H 2

The tires **195/65 VR 14** on **6¹/₂ J x 14 H 2** and **205/55 VR 15** on **7 J x 15 H 2** do not provide sufficient clearance to allow the installation of snow chains.

Use only snow chains according to SAE J 1232 classification "S". The snow chains may be used on drive wheels (rear by twos) only.

Any unauthorized modifications to your car may void your warranty. (See your Warranty Booklet.)

Warning: The use of wheel rims and wheel bolts that do not meet specifications of the original factory installed equipment will affect the safe operation of your vehicle and may cause an accident and personal injury.

Never mix tires of different design such as steel belted radials with radial bias belted or bias ply tires etc. Mixing tire types will adversely affect road holding and can lead to loss of vehicle control.

Roof rack

To ensure the lowest possible roof loads and optimum drag characteristics, use only BMW-tested and -approved luggage ski racks. When installing a **roof rack**, make sure that the mountings fit securely to the roof and are located as far apart as possible.

The roof load must be evenly distributed and not too large. Always stow the heaviest items at the bottom.

Make sure that luggage on the roof is tightly and properly secured, so that there is no danger of it shifting or even coming loose. Consider the danger to other road-users.

Drive smoothly, avoiding jerky starts and sudden braking, and do not take corners and curves too fast.

Luggage on the roof increases the frontal area of the car, leading to higher fuel consumption and roof stresses.

It is recommended the luggage rack be taken off the car when not needed.

The **ski rack** (accessory) should be loaded so that the tail ends of the skis point forwards. Put only one pair of skis in each holder, with poles in the trunk. Check all holders regularly.

Ski racks to match your car can be obtained from your BMW dealer.

PLEASE COMPLY WITH APPLICABLE STATE LAWS.

Antilock Brake System (ABS)

BMW's unceasing efforts to improve its car's active safety have led to the development of the antilock brake system (ABS).

Whenever a brake application is made, the ABS is required to satisfy two fundamental requirements:

- To maintain the car's stability on varying surfaces (asphalt, concrete, mud, wet roads, snow and ice)
- To ensure that the car can be steered and maneuvered under these adverse conditions.

These requirements must be seen in the light of certain essential accompanying factors.

Even ABS is unable to prevent the natural laws of physics from acting on the car. It cannot for instance avoid the consequences of braking when there is insufficient distance remaining to the car in front, when cornering limit speeds are exceeded or if there is a risk of aquaplaning (tires riding up on a cushion of water lying on the road surface). It remains the driver's task to judge speeds and brake applications correctly in such conditions.

The fact that the car may be equipped with ABS must never, despite the increased safety margins this system frequently affords, tempt the driver into taking risks which could affect his safety and that of other road users.

Driving a car equipped with ABS

After the engine has been started, the yellow ANTI LOCK warning light on the instrument panel will go out.

The system itself is then in working order, but does not come into action until road speed exceeds approx. 8 km/h (2.5 mph). After this minimum speed limit has been passed, the ABS can prevent the wheels from locking when the driver applies the brakes. If the speed drops below approx. 3 km/h (2 mph), the ABS will cease to operate, so that in theory the wheels could lock at the very end of a brake application, though in practice this is not critical at such a slow speed. The ABS regulating cycle is repeated over and over again within fractions of a second. To inform the driver that his brake application has caused the ABS to come into action, a pulsating effect is noticed at the brake pedal, together with a characteristic noise. As a warning to watch out for surfaces on which the tires cannot grip well, a "chattering" sound is heard when the ABS is controlling the braking pressure; this reminds the driver to reduce speed to suit the poor road conditions.

The ABS is capable of achieving the shortest possible braking distances in any given conditions (either in a straight line or when the steering wheel is turned, and on smooth asphalt, ice, wet roads etc.).

The braking distance may be slightly longer on loose surfaces on top of a firm base, such as snow, since the skidding wheels of a conventionally-braked car tend to build up a buffer of the loose material as they are forced through it. This may also be the case if snow chains are fitted.

However, the benefits of greater stability and the fact that the car can be steered more than outweigh this occasional slight drawback.

Any modification or repair of the ABS from unauthorized personal can lead to improper working order. Always fit the approved tire sizes.

Any malfunction is indicated by the yellow Antilock warning light on the instrument panel coming on. The brake system then operates conventionally and with precisely the same standards of performance as on cars not equipped with ABS, but keep in mind that the most effective braking action is not achieved with locked wheels, but when the wheels are just turning.

Locking the wheels can be dangerous, as locked front wheels can no longer be steered, and locked rear wheels cause the car to slide sideways or spin.

Caution: Although the ABS is very effective always remember that braking capability is limited by tire traction. Always adjust your driving speed according to the road and traffic conditions. Do not let the extra safety afforded by the ABS tempt you taking extra risks. The ABS cannot overcome the laws of physics.

Disc-type limited-slip differential

In very unfavorable driving conditions the conventional form of differential may be unable to transmit torque to the road wheels without wheelslip occurring. The limited-slip differential greatly reduces the undesirable and possible dangerous situation in which one driven wheel starts to spin.

In practice, this means that improved traction is provided when pulling away, accelerating and taking corners at speed in poor driving conditions.

At the same time, the car tends to spin around the vertical axis at the center of gravity at high power outputs and load reversals on slippery road surfaces. A good deal of skill is required to control a skid and extreme care must be taken especially when driving in an enthusiastic manner.

The locking action is produced by the friction of lined discs, and depends on the load exerted; the differential gear shafts, thrust rings and symmetrically located inner discs tend to move apart and brake the wheel generating the greater accelerative force.

As disc friction takes increasing effect, it retards or entirely prevents wheelspin on that side of the car, so that the other wheel can grip and keep the car moving.

A major advantage of the limited-slip differential is that it operates automatically when needed, and does not have to be engaged by the driver.

Accessory

Mobile communications systems, particularly if not properly designed for automotive use or not properly installed, may adversely affect the operation of the vehicle; for example, such systems, when operated, may cause the engine to stumble or stall. In addition, such systems may themselves be damaged, or their operation affected, by the operation of the vehicle.

Because BMW has no control over the design or manufacture of such systems, or their installation. BMW cannot assume responsibility for any such adverse effects or damage.

Care and maintenance

Your brand-new BMW is a splendid sight. Whether it stays that way, perhaps even for many years, depends on you, and on the care you are prepared to take.

Since the car's paint is exposed to so many potential environmental hazards, automobile manufacturers and paint suppliers are constantly working on further improvements to the strength and durability of modern paints.

The composition of the paints used by BMW, and the manner in which they are applied are to the very latest technical standards in this specialized field.

The manufacturer has used careful design techniques and the latest production methods for the body and other components to ensure that general upkeep of the car is simplified. The materials used were thoroughly tested in laboratories and under practical conditions before being approved, and are constantly being improved or updated as technical standards develop. This is BMW quality down to the last detail.

The high-gloss paint finish is not only chosen to appeal to owner's personal taste as far as the color is concerned, but also to provide maximum protection. It consists of **several layers** for reliable corrosion-proofing; the **body cavities** are not only primer-coated by the cathaphoretic dip process, but also coated with materials specially developed for this purpose in lengthy tests. The entire underside of the floor pan is given a sprayed-on, resilient PVC coating, followed by complete wax-based undersealing.

Every 12 months, during the **Annual Check**, have the body including the underside of the floor pan examined by a BMW dealer. Full details are given in the Warranty and Service Booklet.

It is always more pleasant to drive a clean, well-kept car, but it is equally true to say that regular care and maintenance can make a big contribution to safety and to your car's resale value.

The points to watch are listed below.

A large number of external influences can affect the quality and appearance of your car's paint, some of them purely local in origin. They govern the amount of care the paint will need and how often it should be attended to.

Road dust and dirt, the airborne deposits encountered in industrial areas such as fly ash, lime and soot, even tar stains, dead insects, bird droppings and the stains left when the car is parked under trees all contain various chemicals which, if allowed to remain on for a long time, can damage the paint in the form of patches, blisters, corrosion, flaking paintwork and similar. The car should therefore be washed as often as necessary.

In **industrial areas**, the horizontal panels of the body in particular may suffer from deposits of fly ash, lime, oil soot or substances containing sulphur dioxide ("acid rain"), as well as other less easily identified deposits. Only regular care of the paint can avoid or minimize damage in such circumstances.

In **coastal regions** the high salt content and humidity of the atmosphere greatly increase the risk of body panel corrosion.

In the case of **mechanical damage** caused by sand, road salt, grit etc., the paint surface may be damaged or penetrated, and corrosion may then spread across the panel under the paint.

All you should know about paint care:

To protect the car from the start against gradual deterioration of the paint in areas of high atmospheric pollution or where "natural" substances in the air could damage the paint finish (industrial zones, railways, sap and resin from trees, pollen, bird droppings), it is important to **wash the car once a week**. In severe cases, wash the car whenever the paint finish appears to be dirty.

Remove spilled fuel, oil, grease or brake fluid **at once**, as these substances can attack the paint or change its color.

Bird droppings should also be removed **without delay**, or they will damage the paint.

A new BMW can be put through an automatic car wash, or washed by hand, as soon as it begins to be used on the roads. When using an automatic car wash make sure the accessories (e.g. spoiler) could not be damaged. If necessary contact the car wash owner. Dead insects should be soaked and wiped off **before** the main car wash.

Washing the car should be delayed if the engine compartment lid is still hot, or if the car has been parked or is still standing in strong sunlight, or else sports may form on the paint surface.

When using an **automatic car wash**, try to choose one with low brush pressure, and an ample supply of rinsing water. Most modern car washes satisfy these requirements. However, the areas not fully reached by the automatic system – door sills, panel flanges and seams on doors and lids etc. – should be cleaned by hand.

During the cold season of the year in particular, it is advisable for the car to be washed more frequently, since the heavy dirt deposits and salt from wet roads are more difficult to remove and will damage the entire car if left on too long.

When the car is washed, take the opportunity to clean the interior and trunk with a vacuum cleaner.

If you wash the car by hand, first soften the dirt deposits on the paint with a fine water spray, and rinse them off. Do not spray water directly into the air inlets or outlets of the heating/ventilation system.

After spraying down, wash the upper part of the body starting with the roof with a sponge, or similar item using plenty of cold or lukewarm water. Rinse out the sponge frequently.

Wash the lower part of the body and the wheels last, if possible keeping a separate sponge just for these areas.

After washing, rinse the car again thoroughly with a hose and dry it with a clean chamois leather to prevent discolored spots where the water was not removed.

To protect the paint, a paint-care product can be added to the water used for washing the car.

If washing with water alone is insufficient, a car shampoo or similar cleanser can be used in the concentration stated on the label. After this, rinse with plenty of water.

Note: After washing, the brakes may be wet and therefore less effective in action. Apply them briefly to dry the discs.

Any localized dirt patches or other contamination of the paint surface can best be seen after the car has been washed. Remove them as soon as possible. Eliminate tar stains with a special tar remover.

Polish the paint at these points to restore its appearance and protect it.

Please use only **paint-care products** containing Carnauba or synthetic waxes, and comply with the instructions on the labels.

It is quite easy to decide when the car's paint needs polishing or preservative treatment: water no longer forms large round droplets and tends to roll off the surface. Depending on use of the car, this may arise after some 3 to 4 months.

If the paint tends to lose its high gloss as a result of insufficient care, a suitable **polish** must be applied. **Paint cleaner** is needed if the finish is already dull or weathered. An abrasive **polishing compound** or **paint restorer** should only be used in very severe or obstinate cases. Remember that all polishes, cleaners or paint restorers act by removing a layer of paint and exposing paint which is still in good condition.

Only if the new paint surface is most carefully protected will the overall brilliance of your car's paint be regained.

After care of the car's paint, remove traces of the products used from the windows with a suitable glass cleaner.

Minor paint damage can be touched up with either spray paint or a paint stick, which is used like a brush. The correct paint color designation is on an adhesive label in the engine compartment.

Damage caused by flying stones, scratches etc. must be touched up without delay, to prevent rust from forming.

If damaged areas of paint have already started to rust, use a wire brush to clean them up, and apply rust converter (protect the eyes and skin). Allow a few minutes for this to take effect, then rinse off with water and dry thoroughly. Apply primer and allow to dry, then apply the top coat. After a few days, polish the repaired area and apply a paint preservative.

More extensive paint damage should be professionally repaired in accordance with the manufacturer's instructions. The BMW Service Organization knows and will apply the full repair procedure to ensure a permanent repair of good appearance.

Another important note:

If a tarpaulin or similar sheet is used to protect the car against the weather, moisture condensate may collect (particularly in the case of plastic sheet) and cause the plasticisers to diffuse out of the paint. There is also a severe risk of scratching the paint surface. It is far better to protect your BMW against ultraviolet rays from bright sunlight and against rainfall etc. by giving it the full body care treatment described before. Ideally, in countries where the sun is extremely hot and powerful, a canvas susheet should be stretched above the car.

Annual cleaning and protection or treatment of the engine, engine compartment, underbody, axles and other mechanical assemblies can be carried out by your BMW dealer. This not only reduces the risk of serious corrosion to a minimum, but also avoids short-circuits caused by accumulated oil and dirt, and reveals leaks before they become severe. This treatment is particularly important at the end of the winter season.

For information on the Body-six-year limited anti-corrosion warranty against rust perforation refer to your Warranty Booklet.

Chromium-plated and polished metal parts should be cleaned regularly with water, to which a car shampoo can be added if required. Do not neglect this treatment in winter if salt is spread on the roads.

The car's **radio antenna** should be kept clean to ensure good reception, and can be given a coating of special antenna cleaner to protect it from the weather.

Alloy wheels should be treated with a special wheel-rim cleanser, particularly during the winter months. Do not use aggressive-action products containing acids, strong alkalis or abrasives. Alloy wheels should not be cleaned with a steam jet at a temperature higher than 140° F or 60° C. Please note the manufacturer's instructions for the cleanser.

The **inside surfaces of windows (and mirror glasses)** can be cleaned and smearing avoided with glass cleaner. Never clean mirror glasses with polishing pastes or abrasive (quartz) cleansers.

Plastic components, leatherette upholstery, roof linings, light lenses and items sprayed matt black should be cleaned with water to which a car shampoo may be added. Do not allow the roof lining to become wet right through. If necessary, apply a plastic cleaner to plastic components. Never use solvents such as lacquer thinners, fuel etc.

Rubber components should only be cleaned with water or treated with a rubber cleanser or silicone spray.

Clean the **wiper blades** of the windshield with soapy water. The wiper blades should be replaced twice a year, before and after the cold season.

Carpet and floor mats are possible to clean. For details ask your BMW dealer. For easy cleaning remove floor mats.

Seat belts should only be cleaned with a weak soap and water solution without removal from the car. Never attempt chemical or dry cleaning or else the fabric of the belts may be damaged.

Never allow **automatic (inertia-lock) seat belts** to retract while they are still wet. Clean the seat belts if they become dirty or muddy, as dirt penetrating the reel mechanisms could prevent them from locking or keeping the belts taut and thus constitute a safety risk.

Care of upholstery fabric

The **cloth** used by BMW is notable for hard wear, good heat transmission, freedom from sliding, a soft and attractive surface and easy care.

If certain areas of the seat acquire an unwanted gloss as a result of heat, friction and moisture, they should be brushed "against the pile" with a slightly moistened brush.

The pile of velour material tends to lie flat in use: as with many furnishing fabrics and clothing materials, this is unavoidable and does not detract from its quality.

Fluff and loose threads or abraded leather particles on upholstery fabrics are best removed with a suitable lint brush. Clean off stains or large dirty marks at once with lukewarm water, car-interior cleaner or stain remover. Afterwards, brush the fabric to restore the pile.

If the car is parked for a long time in bright sunlight, it is advisable to cover the seats to prevent bleaching of the colors.

The **upholstery leather** used by BMW on its cars is a high-grade natural product treated by the latest processes. If carefully looked after, it will retain its high quality for many years.

Regular (monthly) cleaning and general care is essential, since dust and road dirt penetrate the pores and creases and cause the surface to wear away and become brittle.

If the car is parked for a long time in bright sunlight, it is advisable to cover the seats and the head rests or better the windows, to prevent bleaching of the colors.

Clean the leather surfaces with a slightly moist cotton or woollen cloth, but do not soak the leather right through at the seams. Dry the leather and rub it with a clean, soft cloth.

Very dirty areas on leather upholstery can be cleaned with a mild detergent (suitable for woollens) containing no brightening agents. Use 2 tablespoons to 1 US quart (one liter) of water.

When using leather care or cleaner agents, rub with a soft cloth and polish after the treatment.

Unightly bald patches or minor surface damage can be rectified with leather spray lacquer.

Cleaning and care of the soft top:

The appearance and lifespan of the soft top depend to a large extent on it being given the proper treatment and care. Park the car in the shade whenever possible to avoid exposure to strong, direct sunlight which could attack the fabric, the rubberized impregnation and the dyes of the soft top.

The vehicle should not go through an automatic car wash. Otherwise the rear window may be scratched, the support bows may be overloaded and damaged and the silicone waxes and polishes used in the car wash may attack the soft top material.

You are recommended to wash the soft top of your Convertible by hand.

The soft top must not be folded or stowed when it is wet or frozen, or water spots and abrasion may result.

Do not leave the soft top stowed in its storage compartment for too long a time, or the rear window may become creased and contact patches may form on the fabric.

For a fairly long period out of use keep the soft top dry and in a well-ventilated space.

Remove bird droppings immediately, as these have a caustic action and will damage the fabric and cause the rubber seals to swell.

Before washing the car, clean the soft top with a soft, dry natural-bristle brush, working along the weave of the fabric in all cases.

If the soft top is not unduly dirty, spray it down with clean water. If dirt is difficult to dislodge or marks are present, apply a mild non-alkaline detergent (for woollens etc.) and rub lightly with a sponge or soft brush along the weave of the fabric (1 tea spoon of detergent to 1 quart/1 litre of water).

Finally, spray the complete soft top with clean water until all traces of suds have been removed.

The soft top should not be washed as often as the rest of the car.

Never use commercial stain remover, solvents, petrol (gasoline), benzene, paint thinners or similar chemical products to remove stains from the soft top, as they destroy the rubberized fabric and cause leaks.

Use only cleaning products approved by BMW.*

* Available from your BMW dealer

Although the rear window is highly flexible, its surface is relatively soft. For this reason, it should only be cleaned with a soft anti-static cloth or a commercial glass cleaner; dilute methylated spirits or a non-alkaline liquid detergent can also be used.

Make sure that the cleaning product does not come into contact with the soft top fabric.

Never remove snow and ice from the rear window with **sharp-edged tools or objects**. De-icing sprays are permitted.

To avoid damage or discoloration, no adhesive tape or plastic sheet should be attached to the rear window or used to cover it up.

During the cold season when a hard top is used it is not necessary to remove the soft top. To avoid waterspots and stains, stretch and dry the fabrics from time to time (approx. 4 weeks).

Clean rubber seals only with water or with a suitable rubber care product, which should be used whenever the rubber feels dry, to improve its flexibility and sealing action. Squeaking on bearings and fittings can be eliminated with a appropriate spray.

Note that the soft top fabric or its seams can begin to leak if not given the proper care or cleaned correctly. In this event, your BMW dealer can arrange for the soft top to be reconditioned.

Warning: Cleaning agents may be poisonous. Keep them out of the reach of children. Observe all caution labels. Always read directions on the container before using any product.

Engine and performance data

BMW 325 i/Convertible	
Displacement – effective	152 in. ³ 2494 cm ³
Max. output at engine speed	168 hp 125 kw 5800 rpm
Max. torque at engine speed	164 ft/lb 222 Nm 4300 rpm
Cylinder	6
Compression ratio	8.8 : 1
Stroke/bore	2.95/3.31 in. 75/84 mm

	BMW 325 i	BMW Convertible
Top speed – manual transmission	132 mph or 212 km/h	130 mph or 209 km/h
Top speed – automatic transmission	130 mph or 209 km/h	130 mph or 209 km/h
Acceleration		
0 – 50 mph / 0 – 80 km/h	5.9 s. 7.2 s.*	6.0 s. 7.4 s.*
Standing start 1/4 mile in	16.4 s. 17.4 s.*	16.5 s. 17.5 s.*

* Automatic model

Engine and performance data

	BMW 325 is/iX¹⁾
Displacement – effective	152 in. ³ 2494 cm ³
Max. output at engine speed	168 hp 125 kw 5800 rpm
Max. torque at engine speed	164 ft/lb 222 Nm 4300 rpm
Cylinder	6
Compression ratio	8.8 : 1
Stroke/bore	2.95/3.31 in. 75/84 mm

	BMW 325 is	BMW 325 iX
Top speed – manual transmission	133 mph or 214 km/h	130 mph or 209 km/h
Top speed – automatic transmission	132 mph or 212 km/h	129 mph or 208 km/h
Acceleration		
0 – 50 mph / 0 – 80 km/h	5.9 s. 7.2* s.	6.2 s. 7.9* s.
Standing start 1/4 mile in	16.4 s. 17.4* s.	16.8 s. 18.0* s.

* Automatic model

¹⁾ For power output testings please consult your BMW dealer.

Dimensions and weights

		BMW 325i	BMW 325i Convertible
Length		170.3 in. or 4325 mm	175.2 in. or 4450 mm
Width		64.8 in. or 1645 mm	
Height (unloaded)		54.3 in. or 1380 mm	53.9 in. or 1370 mm
Wheelbase		101.2 in. or 2570 mm	
Front overhang		30.0 in. or 761 mm	33.3 in. or 845 mm
Rear overhang		39.1 in. or 994 mm	42.3 in. or 1075 mm
Front track		55.4 in. or 1407 mm	
Rear track		55.7 in. or 1415 mm	
Min. turning circle (wheels)		32.15 ft or 9.8 m	
Min. turning circle (overall)		34.45 ft or 10.5 m	
Unloaded weight			
ready for road, tank full	2-door	2811 lb or 1275 kg ¹⁾	2987 lb or 1355 kg ¹⁾
according to FMVSS 110	4-door	2844 lb or 1290 kg ¹⁾³⁾	
Permissible gross weight	2-door	3781 lb or 1715 kg ¹⁾	3825 lb or 1735 kg ¹⁾
	4-door	3814 lb or 1730 kg ¹⁾³⁾	
Permissible rear axle load	2-door	2116 lb or 960 kg	2083 lb or 945 kg
	4-door	2127 lb or 965 kg ⁴⁾	
Permissible front axle load	2-door	1830 lb or 830 kg	1896 lb or 860 kg
	4-door	1852 lb or 840 kg ⁴⁾	
Maximum vehicle load		970 lb or 440 kg	840 lb or 380 kg
Permissible roof load		165 lb or 75 kg	110 lb or 50 kg ²⁾
Trunk capacity acc. to VDA test		14.3 ft ³ or 404 liters	11.0 ft ² or 312 liters

¹⁾ Automatic transmission models add 44 lb/20 kg.²⁾ with special roof carrier, with hardtop 66 lb or 30 kg³⁾ Canadian version add 33 lb or 15 kg.⁴⁾ Canadian version add 11 lb or 5 kg.

Dimensions and weights

		BMW 325 is	BMW 325 iX
Length		170.3 in. or 4325 mm	
Width		64.8 in. or 1645 mm	65.4 in. or 1662 mm
Height (unloaded)		54.3 in. or 1380 mm	55.1 in. or 1400 mm
Wheelbase		101.2 in. or 2570 mm	
Front overhang		30.0 in. or 761 mm	33.3 in. or 845 mm
Rear overhang		39.1 in. or 994 mm	42.3 in. or 1075 mm
Front track		55.4 in. or 1407 mm	55.9 in. or 1420 mm
Rear track		55.7 in. or 1415 mm	55.7 in. or 1416 mm
Min. turning circle (wheels)		32.15 ft or 9.8 m	33.79 ft or 10.3 m
Min. turning circle (overall)		34.45 ft or 10.5 m	36.42 ft or 11.1 m
Unloaded weight (ready for road, tank full according to FMVSS 110)	2-door 4-door	2844 lb or 1290 kg ¹⁾	2954 lb or 1340 kg ¹⁾ 2998 lb or 1360 kg ¹⁾
Permissible gross weight	2-door 4-door	3814 lb or 1730 kg ¹⁾	3924 lb or 1780 kg ¹⁾ 3968 lb or 1800 kg ¹⁾
Permissible rear axle load	2-door 4-door	2127 lb or 965 kg	2116 lb or 960 kg 2150 lb or 975 kg
Permissible front axle load	2-door 4-door	1841 lb or 835 kg	1973 lb or 895 kg 1984 lb or 900 kg
Maximum vehicle load		970 lb or 440 kg	
Permissible roof load		165 lb or 75 kg	
Trunk capacity acc. to VDA test		14.3 ft ³ or 404 liters	

¹⁾ Automatic transmission models add 44 lb/20 kg.

Ratios**Transmission ratios**

	Manual transmission		Automatic
1st	3.84	3.83	2.48
2nd	2.20	2.20	1.48
3rd	1.39	1.40	1.00
4th	1.00	1.00	0.73
5th	0.81	0.81	–
Reverse	3.46	3.46	2.09

BMW 325iX

The ground clearance on your BMW 325iX has not been designed for off-road travel.

However, on sandy and gravel roads the permanently engaged four-wheel-drive with the differential lock will help you to get out of critical situations.

Electrical system

Alternator 90 A, 1260 W
BMW 325iX 95 A, 1330 W

Starter Bosch GF 12V
1.1 kW

Battery 12V, 65 Ah
BMW Convertible 12V, 50 Ah

Spark plugs
Bosch W8LCR
Electrode gap
0.027 + 0.004 in. (0.7 + 0.1 mm)

Firing order 1 – 5 – 3 – 6 – 2 – 4

Warning: The ignition system is a high-performance system, and it is highly dangerous to touch any ignition-components when the engine is running.

INDEX

- Acceleration figures 76
- Air conditioning 29, 85
- Air extraction 27
- Air outlet grills 28
- Alternator 80, 85
- Antenna 44, 74
- Antifreeze 53, 64
- Antilock Brake System (ABS) 70
 - warning light 22
- Ambient temperature display and digital clock 34
- Ashtrays 30
- Automatic transmission 25
 - fluid capacity 84
- Automatic transmission selector lever 25
- Axle loads 78

- Backup lights 62
- Battery 54, 80
- Battery acid level 54
- Battery charge indicator 22
- Blower control (ventilation, heating) 28
- Body cavity sealing 72
- Body dimensions 78
- Body overhang 78
- Brake 47
- Brake and clutch hydraulic fluid level check 53
- Brake fluid 53
- Brake fluid level warning light 22
- Brake lining wear indicator 22
- Brake (stop) lights 62
- Brake pads 47
- Break-in hints 47
- Bulb changing 60

- Capacities 84
- Catalytic converter 46
- Care of car 72
- Central locking system 9
- Central indicator light 22
- Cigarette lighter 30
- Circuit breaker 31
- Chassis number 50
- Check Control, function 23
- Child-proof safety catch 11
- Child restraint system 13, 14
- Chromium, care of 74
- Clock 34, 35
- Cold starting 46
- Cold weather operation 64
- Compression ratio 76
- Convertible soft top 42, 75
- Coolant level check 53
- Coolant temperature gauge 21
- Cooling system capacity 84
- Cruise Control 33

- Differential – see rear axle
- Dimensions 78
- Dimmer switch 18
- Disc brakes 66
- Door locks 9
- Driver's seat adjustment 11
- Driving hints 47, 65

- Electric seat heating 13
- Electric window lifts 31
- Electrical system 80
- Emission Control System 46
- Energy-conscious driving 4, 48
- Engine compartment at a glance 50

- Engine data 76
 - firing order 80
 - hood 49
 - oil adding 51
 - oil grades 52
 - oil level check 51
 - oil press 22, 51
 - specifications 52
- Evaporative Emission Control System 46

- Fasten seat belt warning light 13
- Filling capacities 84
- Firing order 80
- Flashlight 31
- Fog light switch 24
- Foot brake 47, 66
- Four-wheel-drive
 - Brake test 67
 - Towing 57
 - Transmission 84
 - Performance test 77
- Fresh air grills 27
- Front seat adjustment 11
- Front turning lamp 61
- Fuel requirements 5, 48
- Fuel and lubricants 52, 84
- Fuel consumption indicator 20
- Fuel economy 4, 48
- Fuel filler flap 5, 10
- Fuel gauge 21
- Fuel reserve 21
- Fuel tank capacity 84
- Fuses 55

- Glove box 31

- Hazard warning flashers 24
- Head and side marker light switch 17
- Headlights 60
 - inserts 60
 - switch 17

Headrests 12
Heating and ventilation 27
High beam headlights 18, 60
High Mount brake (stop) light 62
Hood 49
Horns 19

Indicator lights 22
Ignition/starter switch 17
Instrument light 17
Instrument panel 18
Interchanging wheels 68
Interior light 63
– switch 30
Interior mirror 16

Jack 57
Jump starting 56

Keys 9
Kick-down 26

Leather upholstery 74
License plate light 63
Lifting points 58
Light switch, see headlight switch
Low beam headlights 60
Lubricants 52, 84

Map reading light 16
Manual transmission 25
Manufacturer's plate 50
Mirrors 16
Modifications, technical 69

Octane number 5, 84
Oil additives 51
Oil level checking 51
Oil pressure warning light 22
On-Board Computer 35
Output, max. 76
Oxygen sensor 46

Paint care 72
Parking brake 24
Parking light 61
Pick-up points 58
Power socket 30
Power steering 52
– fluid content 84
– fluid level check 52
Power windows 31

Radial-ply tires 67
Radio operation 44
Reading lamps 16
Rear axle
– oil capacity 84
– oil grades 84
– oil rates 84
Rear lights 61, 62
Rear window defogger 24
Reverse gear, selecting 25, 26
Roof load 78
Roof rack 70

Seat adjustment 11
Seat belts 13
Seat heating 13
Service indicator 21
Ski bag 41
Ski rack 70
Sliding sunroof 32
– emergency operation 59

Snow chains 65, 69
Spark plugs 80
Spare tire 57
Sports seat 12
Side marker lights 60, 61
Speedometer 20
Starter 80
Starting the car 46
Steering, fluid level check 52
Stop lights 61, 62
Storage out of use 64
Stroke/bore 76
Sunroof 32, 59
Sun visor 16
Supplementary Restraint
System (SRS) 15
Tachometer 20
Tires, punctures 57, 68
Tires inflation pressures 85
Tool kit 56
Top speed 76
Towing away 56
Transmission ratios 80
– gate pattern 25
– fluid capacity 84
– oil grades 84
Tread wear indicator 68
Trip odometer 20
Trunk capacity 78
Trunk light 10, 63
Trunk locking 10
Turn indicator lever 18
Unlock inhibit system 9
V-belts, dimension 85
Vehicle care 72
Vehicle dimension 78
Vehicle identification number 50
Vehicle load 78
Ventilation 27

Warning lights 22
Washer fluid tank 54
Wheel changing 57
Wheel chock 58
Wheel stud wrench 57
Wheel sizes 69
Window lift circuit breaker 31
Window lift switches 31
Windshield washer fluid tank 54
– capacity 84
Windshield washer jets 54
Windshield wipe-wash lever 19
Winter operation 64
Winter tires 65
Wiper blades 59

bimmerfest.com



Filling capacities**Notes**

Fuel tank	16.4 US gal/62 liters	Unleaded gasoline (87 AKI or 91 RON)
Cooling system including heater circuit	11.0 US quarts/10.5 liters	For details, see page 53
Tank for windshield washer	3.2 US quarts/3 liters	For details, see page 54
Engine oil	4.2 US quarts/4.0 liters +0.26 US quarts/0.25 liter if oil filter is changed	Reputable 4-stroke HD engine oil, rated SE or higher (SF, SG). For oil grades, see page 52
Manual transmission	1.32 US quarts/1.25 liters	Reputable non-hypoid gearbox oil SAE 80 specification MIL-L-2105 or API-GL 4 alternatively single-grade HD engine oil (mineral oil based) SAE 20/30/40, specification API-SE or SF (For usage of synthetic lubricants contact your BMW dealer for details).
Auxiliary transmission	BMW 325iX 0.53 US quarts/0.5 liter	ATF-OIL
Automatic transmission	For oil change: approx. 3.2 US quarts/3 liters	Use only automatic transmission fluids of Dexron®II. To avoid overfilling the oil level should only be checked at maintenance intervals. Contact your authorized BMW dealer for further informations.
Rear axle	1.8 US quarts/1.7 liters	Reputable hypoid gear oil SAE 90 (GL-5)
Front axle	BMW 325iX 0.73 US quarts/0.7 liter	
Power steering	Permanently filled, no drain plug	

Service station information

V-belts

Alternator and Water pump
9.5 x 965

Power steering pump
9.5 x 825

Air conditioning compressor
12.5 x 810

The speed rating code letters indicate the maximum permissible road speeds for summer tires (subject to legal limits):

S = up to 110 mile/h (180 km/h)
T = up to 118 mile/h (190 km/h)
H = up to 130 mile/h (210 km/h)
V = up to 149 mile/h (240 km/h)
VR = over 130 mile/h (210 km/h)
ZR = over 149 mile/h (240 km/h)



Permissible maximum speeds for winter tires:

Q – 100 mile/h (160 km/h)
T – 118 mile/h (190 km/h)
H – 130 mile/h (210 km/h)

Use only snow chains according to SAE J 1232 classification "S". The snow chains may be used on drive wheels (rear) only.

For your own safety – check tire pressures regularly

Correct tire pressure is essential for your and everybody's safety. Wrong tire pressure may lead to serious accidents (no driving stability, tire destruction).

BMW model	Radial-ply tubeless tires				
325 i 325 is Convertible	195/65 VR 14	29 (2.0)	32 (2.2)	33 (2.3)	41 (2.8)
	195/65 R 14 89 V				
	195/65 R 14 89 Q M&S				
325 iX ¹⁾	195/65 VR 14	29 (2.0)	32 (2.2)	32 (2.2)	38 (2.6)
	195/65 R 14 89 V				
	205/55 VR 15				
	205/55 R 15 87 V				
	195/65 R 14 89 Q M&S				
	205/55 R 15 87 Q M&S				

Tire pressures in psi (bar) when cold (ambient temperature). On warm tires the pressure can rise for about 4 psi (approx. 0.3 bar). Changes in temperature varies the tire pressure (18° F/10° C = 1.5 psi/0.1 bar)

The tire pressure for future V-rated tires is the same as VR-rated tires.

Your vehicle is equipped with tires which not only meet US standard, but also European standards. We recommend the exclusive use of BMW-approved tires.

¹⁾ Cold tire inflation pressure adequate for speeds up to 110 mph (180 km/h). For speeds higher than 110 mph (180 km/h) add 4 psi/0.3 bar.

- * Convertible: max. 2 persons
- ** Convertible: max. 4 persons



**The ultimate
driving
machine**